Title

Field of Application for:
The Halspan® Prima 60 Range of
Doorsets.
Part 1: Timber Based Door Frames

For 60 minutes Fire Resistance

Report No.:

FEA/F96103 Part 1 Revision S

Issue Date:

2nd December 2025

Valid Until:

30th May 2029

Job Reference:

WF556209

Prepared for:

Halspan Limited

Regent House,
Regent Centre,
West Lothian,
EH49 7HU
United Kingdom

Written permission must be obtained from Halspan Limited in order to manufacture doorsets within the scope of this assessment.

This field of application report FEA/F96103 Part 1 Revision S is one part of the suite of (Prima 60) assessments, other parts of the suite address other doorset designs.

Contents

Contents	2
1 Foreword	5
2 Proposal	6
2.1 Assumptions	6
3 Test Data	7
3.1 Primary Test Evidence	8
4 Technical Specification	100
4.1 General	100
4.2 Intended Use	100
4.3 Door Leaf	100
4.4 Door Frames	101
4.5 Doorset Configurations & Maximum Leaf Sizes	103
5 General Description of Leaf Construction	176
5.1 Leaf Core Construction	176
5.2 Leaf Size Adjustment During Manufacturing	176
5.3 Lipping	177
5.4 Edge Protectors	189
5.5 Decorative & Protective Facings	189
5.6 Decorative Planted on Timber Mouldings	189
5.7 Feature Grooves	191
5.8 Astragal	196
6 Glazing within the Leaf	197
6.1 General	197
6.2 Certifire Single Pane Glass and Glazing System Options	198
6.3 Single Pane Glass and Glazing Systems (Timber Beading)	199
6.4 Single Pane Glass and Glazing Systems (Steel Beading)	216
6.5 Double Glazed Units & Glazing Systems	221
6.6 Hygeno IntaVista & FlushView Units	224
6.7 Zeroplus Slimport	230
7 Door Frame Construction	231
7.1 Details for Frame 1	231
7.2 Details for Frame 2	235
7.3 Details for Frame 3	237
7.4 Details for Frame 4	240
7.5 Details for Frame 5	242

7.6	Details for Frame 7.....	243
7.7	4-sided timber frame with door stop – Frame 1	245
7.8	Hardwood timber threshold without door stop – Frame 1, 2, 3.....	247
7.9	Aluminium Threshold – Frame 1, 2, 3.....	248
7.10	Door Frame Joints.....	249
7.11	Decorative Facings – All Frame Options	250
8	Overpanels & Fanlights, Sidepanel & Sidelights	251
8.1	General	251
8.2	Framing.....	251
8.3	Solid Panels	261
8.4	Glazed Fanlights & Sidelights.....	264
9	Adhesives.....	270
10	Hardware.....	271
10.1	General	271
10.2	Intumescent to Hardware	272
10.3	Essential Hardware	274
10.4	Latches & Locks.....	275
10.5	Handles & Escutcheons	291
10.6	Hinges and Pivots	294
10.7	Doorset Self Closing	303
10.8	Bolts.....	315
10.9	Cable Loops & Cableways	321
10.10	Pull Handles	326
10.11	Push Plates & Kick Plates	327
10.12	Back-to-back recessed pull handles	328
10.13	Security Viewers	329
10.14	Door Selectors	330
10.15	Air Transfer Grilles	330
10.16	Environmental Seals.....	331
10.17	Threshold drop seals	332
10.18	Letter Box / Plate	334
10.19	Knockers, Numerals & Signage.....	335
10.20	Security Chain.....	336
10.21	Fire Door Identification Plates	336
10.22	Panic Hardware.....	337
10.23	Halspan Smart Tags	338
10.24	Overhead door operator	339

10.25	Sensors.....	340
10.26	Roller Catches.....	341
10.27	Rain Deflector	342
10.28	Hold Open Armatures.....	342
11	Installation	343
11.1	General.....	343
11.2	Door Frame Installation	343
11.3	Firestopping	354
11.4	Packers.....	358
11.5	Wall Types, Structural Opening & Fixity	358
11.6	Post Production (Onsite) Leaf Size Adjustment.....	359
11.7	Door Gaps.....	360
12	Insulation Performance.....	360
13	Conclusion	361
14	Declaration by the Applicant.....	362
15	Limitations	363
16	Validity.....	364
	Appendix A: Revisions	365

1 Foreword

This Field of Application report has been commissioned by Halspan Limited and relates to the fire resistance of 60 minute fire resisting doorset designs.

The report is for national application and has been written in accordance with the general principles outlined in BS EN 15725.

This Field of Application (scope) uses established empirical methods of extrapolation and experience of fire testing similar doorsets, in order to extend the scope of application by determining the limits for the designs based on the tested constructions and performances obtained. The scope is an evaluation of the potential fire resistance performance, if the variations specified herein were to be tested in accordance with BS 476-22: 1987.

This Field of Application has been written using appropriate test evidence generated at UKAS accredited laboratories¹, to the relevant test standard. The supporting test evidence has been deemed appropriate to support the manufacturers stated door design and is summarised in section 3.

The scope presented in this report relates to the behaviour of the proposed door design variations under the particular conditions of the test; they are not intended to be the sole criterion for considering the potential fire hazard of the door assembly in use.

This Field of Application has been prepared and checked by product assessors with the necessary competence, who subscribe to the principles outlined in the Passive Fire Protection Forum (PFPF) '*Guide to Undertaking Technical Assessments of the Fire Performance of Construction Products Based on Fire Test Evidence*'. The aim of the PFPF guidelines is to give confidence to end-users that assessments that exist in the UK are of a satisfactory standard to be used for building control and other purposes.

¹ Test evidence from overseas laboratories has also been considered as supporting evidence for the designs in this assessment report. The test evidence is from a laboratory that has been accredited by a national accreditation body that is a signatory of the International Laboratories Accreditation Co-operation (ILAC).

The drawings provided in this report are for guidance and illustrative purposes only. Please note that the written scope of application takes precedence.

2 Proposal

It is proposed to consider the fire resistance performance of the specified proprietary Halspan Prima 60 doorset designs with timber based frames, for 60 minutes fire resistance integrity performance (and where appropriate insulation performance), if the doorset designs were to be tested to the requirements of BS 476-22: 1987, *Methods for determination of the fire resistance of non-loadbearing elements of construction*.

The field of application defined in this report is based on the fire resistance test evidence for the doorset design, which is summarised in section 3. Analysis of specific construction details that require assessment are given within this report against the relevant element of construction, as appropriate.

Whilst specific items are included within this Field of Application report that may be used to provide additional performance characteristics (such as acoustic or smoke control for example), it is beyond the remit of this Field of Application report to provide scope for performance characteristics other than fire resistance integrity and (where applicable) insulation performance. Any other performance requirement for the door designs contained herein is to be subject to a separate analysis.

2.1 Assumptions

- All densities referred to in this document are based upon an assumed moisture content of 12%.
- It is assumed that unless otherwise documented in the field of application sections of this report, the doorset subject to this report will be constructed in accordance with the test evidence referred to herein.
- For components created using solid timber sections referred to in this assessment, it is assumed that, for all timbers, they will be of a quality deemed to meet or exceed class J30 as specified in BS EN 942: 2007, subject to adequate repairs, other than glazing beads which must meet a minimum class J10. Note that areas under intumescent seals/gaskets are not considered to be concealed faces and defects must be repaired.
- Where timber is referred to within this document it is assumed that the timber element is made from a continuous solid piece, unless specifically detailed otherwise.
- All dimensions detailed herein may be varied by $\pm 2\%$ except where minimum, maximum or a range of dimensions are given.
- Where morticed items of hardware are used (within the leaf or frame) it is assumed that the preparation for such items are tight to the item (and where applicable intumescent protection) as tested with no excessive gaps, unless stated otherwise within a particular section of this report.
- If a design variation or extension to scope is not explicitly detailed within the assessment it should not be assumed to be acceptable by omission.

3 Test Data

The test evidence summarised below has been generated to support the fire resistance performance of the door designs that are the subject of this field of application. The summary details are considered to be the key aspects of the design tested. These test summaries are not intended to be a definitive guide to constructing a doorset. The details for the construction of a doorset must be taken from other sections within this Field of Application.

Note:

- Dimensions are in mm unless otherwise stated.
- Abbreviations: (h) = height; (w) = width; (t) = thickness; (d) = deep; (l) = long.
- Latches fitted but disengaged for the test, are reported as 'unlatched'.

The test evidence has been generated across a number of different doorset configurations, including single leaf, double leaf, latched and unlatched doorsets as well as doorsets with sidescreens and overpanels.

The test data used to support this product has been gathered over 20 years and has been deemed relevant to support the scope detailed in this assessment, as the basic core composition has remained unchanged over this period of time. Furthermore, the older data has been supported and supplemented with more recent data, which provides additional confidence that the evidence cited in this assessment is suitable to support the scope of the designs in this field of application. Other test evidence on designs that are fundamentally the same as the Halspan Prima design have been included where appropriate.

Some of the test evidence used in the evaluation is over 5 years old. In accordance with industry guidance, the evidence has been reviewed to consider its suitability. Warringtonfire are satisfied that there have been no significant revisions to the relevant test standards which would render the evidence irrelevant.

The evidence has been generated to BS 476 Part 22: 1987 and EN 1634-1. The latter is known to be more onerous than the BS 476: Part 22: 1987 standard, primarily due to the use of plate thermocouples within the furnace to record the furnace temperature.

The same time temperature curve is used to control the temperature within the furnace for both test methods (the heating curve given within ISO 834-1). However, the plate thermocouple used to record the temperature within the furnace for the EN test method, requires a longer thermal exposure to read the same temperature as the probe thermocouple that is used for the BS 476: Part 22: 1987 test, particularly during the early stages of the test. Furthermore, the neutral pressure regime is positioned lower relative to the specimen height in a European fire door test, therefore resulting in greater relative positive pressure conditions than those expected in a BS 476-22: 1987 test, which has the potential to increase hot gases and flaming on the unexposed side. These factors result in more onerous test conditions for doorsets tested to the BS EN 1634-1 test standard compared with the BS 476: Part 22: 1987 test standard, which has been demonstrated by testing the same products to both standards.

It is therefore the opinion of Warringtonfire that the evidence cited in the following section, tested to both named standards referenced above can be utilised in this assessment which will conclude in terms of the fire resistance performance of the Prima 60 doorset designs with timber based frames if tested in accordance with BS 476: Part 22: 1987.

Originally, the Halspan product range was called Halspan 60. Thereafter, this product was sub-divided into 2 product ranges Prima and Optima. The physical properties and respective average densities of these production options differed slightly, however, the technical attributes of Prima 60 and Optima 60 over the years has demonstrated, by testing, that the products performance in fire test conditions is positively comparable.

Therefore, in regard to base line data and generic performance, coupled with laboratory test results it is possible to transfer product characteristics between Halspan 60, Prima 60 and Optima 60. All the evidence contained herein has been deemed appropriate and relevant to this assessment.

The test evidence developed by Halspan is the primary evidence to support the leaf type being evaluated in this assessment namely:

- Prima 54mm thick

Additional evidence produced by 3rd parties has been used to supplement this assessment. This evidence is used with the permission of the owner of the test evidence.

3.1 Primary Test Evidence

The following summaries are provided to give the key details relevant to the tested specimen. Throughout this assessment report, relevant sections will reference the tests where they have been used to provide the scope of application.

3.1.1 Test Report WF509420

Date of Test:	06.DEC.2021
Identification of Test Body:	Warringtonfire Testing and Certification Ltd. UKAS No. 1762
Sponsor:	Halspan Limited
Tested Product:	Double Acting, Double Leaf Doorset with Glazed Apertures – DADD.
Tested Orientation:	Doorset opens in both directions, towards and away from the test conditions.
Sampling information:	Warringtonfire, FM511241, 30 th Nov 2021
Test Standard:	BS EN 1634-1:2014+A1:2018
Performance:	Integrity: Sustained flaming: 71 minutes Cotton pad test: 74 minutes Gap gauge: 74 minutes Insulation: Insulation I ₂ : 53 minutes
Reason for Use	For use as primary evidence for: <ul style="list-style-type: none">• configuration and leaf sizes for Lorient intumescent, with a rectangular MDF frame.• Hygeno IntaVista & FlushView glazing units• Electronic morticed head mounted locking• Concealed transom closer• HTM 58 identification tags• Tracker tags

3.1.2 Test Report LP-636.7/09

Date of Test:	22.JUN.2010
Identification of Test Body:	Instytut Techniki Budowlanej (ITB) ILAC (PCA – Polskie Centrum Akredytacji): AB 023
Sponsor:	Halspan Limited
Tested Product:	Latched, Single Acting, Double Leaf, Doorset with Glazed Apertures – LSADD.
Tested Orientation:	Opening in towards the furnace
Sampling information:	No sampling report included
Test Standard:	PN-EN 1634-1: 2009
Performance:	Integrity: 62 minutes Insulation: 62 minutes
Reason for Use	For use as primary evidence for: <ul style="list-style-type: none"> • configuration and leaf sizes for Halspan intumescent, tested with a rectangular hardwood frame. • Glazing systems

3.1.3 Test Report CFR1707241

Date of Test:	24.JUL.2017
Identification of Test Body:	Cambridge Fire Research Ltd. UKAS No. 4319
Sponsor:	Halspan Limited
Tested Product:	Latched, Single Acting, Double Leaf Doorset – LSADD.
Tested Orientation:	Opening in towards the furnace
Sampling information:	No sampling report included
Test Standard:	BS 476: Part 22: 1987
Performance:	Integrity: 62 minutes Insulation: 62 minutes
Reason for Use	For use as primary evidence for <ul style="list-style-type: none"> • Configuration and leaf sizes for Halspan seals in a rectangular sapele frame. • Hardware

3.1.4 Test Report WF384748 B

Date of Test:	29.JUN.2017
Identification of Test Body:	Exova Ltd UKAS No. 1762 (Now trading as: Warringtonfire Testing and Certification Limited)
Sponsor:	Halspan Ltd
Tested Product:	Latched, Single Acting, Single Leaf Doorset – LSASD.
Tested Orientation:	Opening in towards the furnace
Sampling information:	No sampling report included
Test Standard:	BS 476: Part 20/22: 1987
Performance:	Integrity: 63 minutes Insulation: 63 minutes
Reason for Use	For use as primary evidence for: <ul style="list-style-type: none"> • configuration and leaf sizes for Halspan intumescent, with a rectangular hardwood frame. • Single point lock

3.1.5 Test Report WF380349 AR1 B

Date of Test:	12.APR.2017
Identification of Test Body:	Exova Ltd UKAS No. 1762 (Now trading as: Warringtonfire Testing and Certification)
Sponsor:	Halspan Ltd
Tested Product:	Doorset B: Latched, Single Acting, Single Leaf, Doorset – LSASD.
Tested Orientation:	Doorset B: Opening in towards the furnace
Sampling information:	No sampling report included
Test Standard:	BS 476: Part 20/22: 1987
Performance:	Integrity: 76 minutes (Doorset B) Insulation: 76 minutes (Doorset B)
Reason for Use	For use as primary evidence for: <ul style="list-style-type: none"> • configuration and leaf sizes for Halspan intumescent, with a rectangular hardwood frame. • Single point locks • Steel Bead glazing systems

3.1.6 Test Report WF375153 AR1 B

Date of Test:	22.DEC.2016
Identification of Test Body:	Exova Ltd UKAS No. 1762 (Now trading as: Warringtonfire Testing and Certification Ltd)
Sponsor:	Halspan Ltd
Tested Product:	Doorset B: Latched, Single Acting, Single Leaf Doorset – LSASD.
Tested Orientation:	Doorset B: Opening in towards the furnace
Sampling information:	No sampling report included
Test Standard:	BS 476: Part 20/22: 1987
Performance:	Integrity: 72 minutes (Doorset B) Insulation: 72 minutes (Doorset B)
Reason for Use	For use as primary evidence for: <ul style="list-style-type: none"> configuration and leaf sizes for Halspan intumescent, with a rectangular hardwood frame.

3.1.7 Test Report CFR1802131_2

Date of Test:	13.FEB.2018
Identification of Test Body:	Cambridge Fire Research Ltd. UKAS No. 4319
Sponsor:	Halspan Limited
Tested Product:	Doorset: Unlatched, Single Acting, Single Leaf Doorset with Flush Overpanel – ULSASD+OP
Tested Orientation:	Doorset: Opening towards the furnace
Sampling information:	No sampling report included
Test Standard:	BS 476: Part 22: 1987
Performance:	Integrity: 63 minutes Insulation: 63 minutes
Reason for Use	For use as primary evidence for: <ul style="list-style-type: none"> configuration and leaf sizes for Halspan intumescent, with a rectangular hardwood frame. Flush rebated overpanel Timber lippings
Failure Mode:	Test discontinued, no failure at 63 minutes

3.1.8 Test Report Chilt/RF13167

Date of Test:	29.JUL.2013
Identification of Test Body:	Chiltern International Fire Ltd. UKAS No. 1762 (Now trading as: Warringtonfire Testing and Certification Ltd)
Sponsor:	Halspan Ltd
Tested Product:	Unlatched, Single Acting, Double Leaf Doorset with glazing apertures – ULSADD.
Tested Orientation:	Doorset: Opening in towards the furnace
Sampling information:	BM Trada, 'Halspan order 7743881 & 7653401', 21 st March 2013
Test Standard:	BSEN 1634-1:2008
Performance:	<p>Integrity: Sustained flaming: 60 minutes Cotton pad test: 62 minutes Gap gauge: 62 minutes</p> <p>Insulation: Insulation I₁: 56 minutes Insulation I₂: 60 minutes</p>
Reason for Use	<p>For use as primary evidence for:</p> <ul style="list-style-type: none"> • configuration and leaf sizes for Halspan intumescent, with a rectangular hardwood frame. • Hardware intumescent • Flushbolts • Glazing systems

3.1.9 Test Report RF98051

Date of Test:	20.JUL.1998
Identification of Test Body:	Chiltern International Fire NAMAS No. 1762 (Now trading as Warringtonfire Testing and Certification Limited, UKAS No. 1762)
Sponsor:	Timber & Door Products (now trading as: Halspan Ltd)
Tested Product:	Unlatched, Single Acting, Double Leaf Doorset with Flush Overpanel and glazing apertures – ULSADD+OP.
Tested Orientation:	Opening in towards the furnace
Sampling information:	No sampling report included
Test Standard:	BS 476: Part 22: 1987
Performance:	<p>Integrity: Integrity: 59 minutes</p> <p>Insulation: Insulation: 59 minutes</p> <p>In accordance with Section 7.6.1.1 of BS 476: Part 22: 1987, the glazing has not been evaluated for insulation</p>
Reason for Use	<p>For use as primary evidence for:</p> <ul style="list-style-type: none"> • configuration and leaf sizes for Lorient intumescent, with a rectangular hardwood frame. • Timber lipping • Circular apertures. <p>The 59-minute integrity failure at the glazing has been ignored as the glass and glazing system for rectangular apertures used within the test has not been included within this assessment.</p>
Failure Mode:	<p>Initial Failure: Continuous flaming at right hand leaf glazing perimeter at 59 minutes.</p> <p>No further failure until in excess of 62 minutes of elapsed test duration.</p>

3.1.10 Test Report WF504390

Date of Test:	11.JUN.2021
Identification of Test Body:	Warringtonfire Testing and Certification Ltd. UKAS No. 1762
Sponsor:	Halspan Limited
Tested Product:	Double Acting, Double Leaf Doorset with Glazed Apertures – DADD.
Tested Orientation:	Doorset opens in both directions, towards and away from the test conditions.
Sampling information:	BM Trada, SC21045, 11 th and 12 th May 2021
Test Standard:	BS EN 1634-1:2014+A1:2018
Performance:	Integrity: Sustained flaming: 61 minutes Cotton pad test: 63 minutes Gap gauge: 63 minutes Insulation: Insulation I ₂ : 43 minutes
Reason for Use	For use as primary evidence for: <ul style="list-style-type: none">• configuration and leaf sizes for Pyroplex intumescent, with a rectangular hardwood frame.• Timber lipping• Hardware• Concealed transom closers and pivots• Glazing systems

3.1.11 Test Report Chilt/RF03041 A

Date of Test:	17.MAR.2003
Identification of Test Body:	Chiltern International Fire UKAS No. 1762 (Now trading as Warringtonfire Testing and Certification Limited)
Sponsor:	Halspan Ltd
Tested Product:	Unlatched, Single Acting, Double Leaf Doorset – ULSADD.
Tested Orientation:	Doorset A: Opening in towards the furnace
Sampling information:	No sampling report included
Test Standard:	BS 476: Part 22: 1987
Performance:	Integrity: 61 minutes Insulation: 61 minutes
Reason for Use	For use as primary evidence for: <ul style="list-style-type: none"> configuration and leaf sizes for Lorient intumescent, with a rectangular hardwood frame.

3.1.12 Test Report Chilt/RF03041 B

Date of Test:	17.MAR.2003
Identification of Test Body:	Chiltern International Fire UKAS No. 1762 (Now trading as Warringtonfire Testing and Certification Limited)
Sponsor:	Halspan Ltd
Tested Product:	Unlatched, Single Acting, Single Leaf, Flush timber Doorset – ULSASD.
Tested Orientation:	Doorset B: Opening in towards the furnace
Sampling information:	No sampling report included
Test Standard:	BS 476: Part 22: 1987
Performance:	Integrity: 61 minutes Insulation: 61 minutes
Reason for Use	For use as primary evidence for: <ul style="list-style-type: none"> configuration and leaf sizes for Lorient intumescent, with a rectangular hardwood frame.

3.1.13 Test Report WF512409

Date of Test:	27.JAN.2022
Identification of Test Body:	Warringtonfire Testing and Certification Ltd. UKAS No. 1762
Sponsor:	Halspan Limited
Tested Product:	Doorset A: Latched, Single Acting, Single Leaf Doorset with a Glazed Aperture – LSASD. Doorset B: Latched, Single Acting, Single Leaf Doorset with a Glazed Aperture – LSASD
Tested Orientation:	Doorset A: Opening away from the furnace Doorset B: Opening towards the furnace
Sampling information:	BM Trada, SC22001, 20 th and 21 th January 2022
Test Standard:	BS EN 1634-1:2014+A1:2018
Performance:	<p>Integrity: Doorset A: Sustained flaming: 58 minutes Cotton pad test: 24 minutes Gap gauge: 69 minutes Doorset B: Sustained flaming: 63 minutes Cotton pad test: 62 minutes Gap gauge: 69 minutes</p> <p>Insulation: Doorset A: Insulation I₂: 24 minutes Doorset B: Insulation I₂: 49 minutes</p>
Reason for Use	For use as primary evidence for: <ul style="list-style-type: none"> • Glazing Systems • Hardware
Failure Mode:	The doorset tested is of a differing design to the one assessed herein, this evidence though failures have been observed has been used to support elements which have been determined not to have influenced or caused the failure on the tested element.

3.1.14 Test Report Chilt/RF07128 A

Date of Test:	13.SEP.2007
Identification of Test Body:	Chiltern International Fire UKAS No. 1762 (Now trading as Warringtonfire Testing and Certification Limited)
Sponsor:	Halspan Ltd
Tested Product:	Unlatched, Single Acting, Single Leaf Doorset – ULSASD.
Tested Orientation:	Doorset A: Opening in towards the furnace
Sampling information:	No sampling report included
Test Standard:	BS 476: Part 22: 1987
Performance:	Integrity: 72 minutes Insulation: 72 minutes
Reason for Use	For use as primary evidence for: <ul style="list-style-type: none">• configuration and leaf sizes for Lorient intumescent, with a rectangular hardwood frame.

3.1.15 Test Report WF509421

Date of Test:	30.NOV.2021
Identification of Test Body:	Warringtonfire Testing and Certification Ltd. UKAS No. 1762
Sponsor:	Halspan Limited
Tested Product:	Double Acting, Double Leaf Doorset with, Glazed Apertures – DADD.
Tested Orientation:	Doorset opens in both directions, towards and away from the test conditions.
Sampling information:	Warringtonfire, FM510818, 25 th November 2021
Test Standard:	BS EN 1634-1:2014+A1:2018
Performance:	<p>Integrity: Sustained flaming: 69 minutes Cotton pad test: 71 minutes Gap gauge: 71 minutes</p> <p>Insulation: Insulation I₂: 61 minutes</p>
Reason for Use	<p>For use as primary evidence for:</p> <ul style="list-style-type: none"> • configuration and leaf sizes for Lorient intumescent, with a rectangular MDF frame. • Hygeno IntaVista & FlushView glazing Units • Morticed head mounted electronic locks • Floor springs • Tracker Tags

3.1.16 Test Report Chilt/RF01056 B

Date of Test:	9.JUL.2001
Identification of Test Body:	Chiltern International Fire UKAS No. 1762 (Now trading as Warringtonfire Testing and Certification Limited)
Sponsor:	Halspan Ltd
Tested Product:	Unlatched, Single Acting, Single Leaf Doorset with Glazed aperture – ULSASD.
Tested Orientation:	Doorset B: Opening in towards the furnace
Sampling information:	No sampling report included
Test Standard:	BS 476: Part 22: 1987
Performance:	Integrity: 61 minutes Insulation: 6 minutes
Reason for Use	For use as primary evidence for: <ul style="list-style-type: none"> • configuration and leaf sizes for Mann McGowan intumescent, with a rectangular hardwood frame. • Glazing systems • Feature Grooves

3.1.17 Test Report RF07128 B

Date of Test:	13.SEP.2007
Identification of Test Body:	Chiltern International Fire UKAS No. 1762 (Now trading as Warringtonfire Testing and Certification Limited)
Sponsor:	Halspan Ltd
Tested Product:	Unlatched, Single Acting, Single Leaf Doorset – ULSASD.
Tested Orientation:	Doorset B: Opening in towards the furnace
Sampling information:	No sampling report included
Test Standard:	BS 476: Part 22: 1987
Performance:	Integrity: 67 minutes Insulation: 67 minutes
Reason for Use	For use as primary evidence for: <ul style="list-style-type: none"> • configuration and leaf sizes for Mann McGowan intumescent, with a rectangular hardwood frame.

3.1.18 Test Report RF02018 RevA

Date of Test:	26.FEB.2002
Identification of Test Body:	Chiltern International Fire UKAS No. 1762 (Now trading as Warringtonfire Testing and Certification Limited)
Sponsor:	Pyroplex Ltd
Tested Product:	Double Acting, Double Leaf Doorset – DADD.
Tested Orientation:	Doorset opens in both directions, towards and away from the test conditions.
Sampling information:	No sampling report included
Test Standard:	BS 476: Part 22: 1987
Performance:	Integrity: 73 minutes Insulation: 73 minutes
Reason for Use	For use as primary evidence for: <ul style="list-style-type: none">• configuration and leaf sizes for Pyroplex intumescent, with a rectangular hardwood frame.• Timber lippings• Pivots and floor spring

3.1.19 Test Report CFR2103161

Date of Test:	16.MARCH.2021
Identification of Test Body:	Cambridge Fire Research Ltd. UKAS No. 4319
Sponsor:	Halspan Limited
Tested Product:	Unlatched, Single Acting, Double Leaf Doorset with Flush Overpanel – ULSADD+OP.
Tested Orientation:	Opening in towards heating condition
Sampling information:	BM Trada, SC21010, 10 th March 2021
Test Standard:	BS EN 1634-1:2014+A1:2018
Performance:	Integrity: Sustained flaming: 65 minutes Cotton pad test: 64 minutes Gap gauge: 65 minutes Insulation: Insulation I ₂ : 64 minutes
Reason for Use	For use as primary evidence for: <ul style="list-style-type: none">• configuration and leaf sizes for Pyroplex intumescent, with a rectangular hardwood frame.• Hardware• Overhead face fixed closers• Face mounted threshold drop seals

3.1.20 Test Report BMT/FEP/F15163

Date of Test:	18.JUN.2015
Identification of Test Body:	BM TRADA UKAS No. 1762 (Now trading as Warringtonfire Testing and Certification Limited)
Sponsor:	Sealed Tight Solutions Ltd
Tested Product:	Latched, Single Acting, Double Leaf Doorset with glazing aperture – ULSADD.
Tested Orientation:	Opening in towards the furnace
Sampling information:	No sampling report included
Test Standard:	BS 476: Part 20/22: 1987
Performance:	Integrity: 51 minutes Insulation: 0 minutes In accordance with Section 8.6.1 of BS 476: Part 22: 1987, the specimen has not been evaluated for insulation
Reason for Use	For use as primary evidence for: <ul style="list-style-type: none">• configuration and leaf sizes for STS intumescent, with a rectangular hardwood frame. The 51-minute integrity failure at the glazing has been ignored as the glass and glazing system used within the test has not been included within this assessment.
Failure Mode:	Initial Failure: Continuous flaming at glazing perimeter at 51 minutes No further failure was observed until in excess of 69 minutes.

3.1.21 Test Report BMT/FEP/F15012B

Date of Test:	06.FEB.2015
Identification of Test Body:	BM TRADA UKAS No. 1762 (Now trading as Warringtonfire Testing and Certification Limited)
Sponsor:	Halspan Ltd
Tested Product:	Unlatched, Single Acting, Single Leaf Doorset – ULSASD.
Tested Orientation:	Opening in towards the furnace
Sampling information:	No sampling report included
Test Standard:	BS EN 1634-1:2014
Performance:	Integrity: Sustained flaming: 64 minutes Cotton pad test: 64 minutes Gap gauge: 72 minutes Insulation: Insulation I ₂ : 64 minutes
Reason for Use	For use as primary evidence for: <ul style="list-style-type: none">• configuration and leaf sizes for Lorient intumescent with a rectangular MDF frame, fitted flush with the supporting construction.• Hardware

3.1.22 Test Report CFR2211141 LH

Date of Test:	14.NOV.2022
Identification of Test Body:	Cambridge Fire Research Ltd. UKAS No. 4319
Sponsor:	Halspan Ltd
Tested Product:	Unlatched, Single Acting, Double Leaf Doorset – ULSADD.
Tested Orientation:	Opening towards the furnace
Sampling information:	BM Trada, SC22141 & SC22143, 8 th November 2022
Test Standard:	BS EN 1634-1:2014+A1:2018
Performance:	<p>Integrity: Sustained flaming: 78 minutes Cotton pad test: 81 minutes Gap gauge: 81 minutes</p> <p>Insulation: Insulation I₂: 78 minutes</p>
Reason for Use	<p>For use as primary evidence for:</p> <ul style="list-style-type: none"> • configuration and leaf sizes for Lorient intumescent with a rectangular MDF frame, fitted flush with the supporting construction. • Hardware • configuration and leaf sizes for Halspan intumescent with a 2 part MDF frame with integral architrave. • Assessed for Hardwood with the same frame section design. • Supporting MDF rectangular frames, fitted flush with the supporting construction. • Supporting MDF and Hardwood projecting frames. • Hardware • Surface mounted face fixed bolts • Cable loops • Cable ways • Installation method • Environmental seals • Firestopping

3.1.23 Test Report CFR2211141 RH

Date of Test:	14.NOV.2022
Identification of Test Body:	Cambridge Fire Research Ltd. UKAS No. 4319
Sponsor:	Halspan Ltd
Tested Product:	Latched, Single Acting, Double Leaf Doorset – LSADD.
Tested Orientation:	Opening towards the furnace
Sampling information:	BM Trada, SC22141 & SC22143, 8 th November 2022
Test Standard:	BS EN 1634-1:2014+A1:2018
Performance:	<p>Integrity: Sustained flaming: 76 minutes Cotton pad test: 81 minutes Gap gauge: 81 minutes</p> <p>Insulation: Insulation I₂: 76 minutes</p>
Reason for Use	<p>For use as primary evidence for:</p> <ul style="list-style-type: none"> • configuration and leaf sizes for Lorient intumescent with a rectangular MDF frame, fitted flush with the supporting construction. • Hardware • configuration and leaf sizes for Halspan intumescent with a 2 part MDF frame with integral architrave. • Assessed for Hardwood with the same frame section design. • Supporting MDF rectangular frames, fitted flush with the supporting construction. • Supporting MDF and Hardwood projecting frames. • Hardware • Surface mounted face fixed bolts • Cable loops • Cable ways • Installation method • Environmental seals • Firestopping

3.1.24 Test Report CFR1809241

Date of Test:	24.SEP.2018
Identification of Test Body:	Cambridge Fire Research Ltd. UKAS No. 4319
Sponsor:	Halspan Ltd
Tested Product:	Unlatched, Single Acting, Double Leaf Doorset – ULSADD.
Tested Orientation:	Opening in towards the furnace
Sampling information:	No sampling report included
Test Standard:	BS 476: Part 22: 1987
Performance:	Integrity: 61 minutes Insulation: 61 minutes
Reason for Use	For use as primary evidence for: <ul style="list-style-type: none">• configuration and leaf sizes for Halspan intumescent with a rectangular Beech frame• Hardware

3.1.25 Test Report FRR-2010/2942

Date of Test:	04.OCT.2020
Identification of Test Body:	Material Lab Testing Services L.L.C., Dubai ILAC (EIAC – Emirates International Accreditation Centre): 008-LB-TEST
Sponsor:	Halspan Limited
Tested Product:	Latched, Single Acting, Double Leaf Doorset with glazed aperture – LSADD.
Tested Orientation:	Opening in towards the furnace
Sampling information:	No sampling report included
Test Standard:	BS 476: Part 20/22: 1987/Amd: 2014
Performance:	Integrity: 70 minutes Insulation: 70 minutes In accordance with clause 8.7.5.2 of BS 476: part 22: 1987 the specimen has not been evaluated for insulation
Reason for Use	For use as primary evidence for: <ul style="list-style-type: none"> • configuration and leaf sizes for Firestop intumescent with a rectangular Beech frame • Steel Bead glazing systems • Hardware Intumescent • Hardware • Flush bolts with rebated meeting edges • Rebated threshold drop seals

3.1.26 Test Report FRR-2009/2351

Date of Test:	09.SEP.2020
Identification of Test Body:	Material Lab Testing Services L.L.C., Dubai ILAC (EIAC – Emirates International Accreditation Centre): 008-LB-TEST
Sponsor:	Halspan Limited
Tested Product:	Double Acting, Double Leaf, Flush timber Doorset – DADD.
Tested Orientation:	Doorset opens in both directions, towards and away from the test conditions.
Sampling information:	No sampling report included
Test Standard:	BS 476: Part 20/22: 1987/Amd: 2014
Performance:	Integrity: 71 minutes Insulation: 71 minutes
Reason for Use	For use as primary evidence for: <ul style="list-style-type: none"> • configuration and leaf sizes for Lorient intumescent with a rectangular Beech frame • Hardware • Feature Grooves

3.1.27 Test Report FRR-2009/1221 (SP1)

Date of Test:	09.SEP.2020
Identification of Test Body:	Material Lab Testing Services L.L.C., Dubai ILAC (EIAC – Emirates International Accreditation Centre): 008-LB-TEST
Sponsor:	Halspan Limited
Tested Product:	Specimen 1 (SP1): Latched, Single Acting, Single Leaf Doorset – LSASD.
Tested Orientation:	Specimen 1 (SP1): Opening in towards the furnace
Sampling information:	No sampling report included
Test Standard:	BS 476: Part 20/22: 1987/Amd: 2014
Performance:	Integrity: 75 minutes Insulation: 75 minutes
Reason for Use	For use as primary evidence for: <ul style="list-style-type: none"> • configuration and leaf sizes for Lorient intumescent with a rectangular Beech frame • Security viewers • Environmental Seals • Feature Grooves

3.1.28 Test Report FRR-2110/1497

Date of Test:	13.OCT.2021
Identification of Test Body:	Material Lab Testing Services L.L.C., Dubai ILAC (EIAC – Emirates International Accreditation Centre): 008-LB-TEST
Sponsor:	Halspan Limited
Tested Product:	Latched, Single Acting, Single Leaf Doorset with glazing aperture – LSASD.
Tested Orientation:	Opening in towards the furnace
Sampling information:	No sampling report included
Test Standard:	BS 476: Part 20/22: 1987/Amd: 2014
Performance:	Integrity: 70 minutes Insulation: 70 minutes In accordance with clause 7.6 of BS 476: part 22: 1987 the glass has not been evaluated for insulation
Reason for Use	For use as primary evidence for: <ul style="list-style-type: none"> • configuration and leaf sizes for Lorient intumescent with a rectangular Beech frame • Steel Bead glazing Systems • Hardware Intumescent • Hardware • Concealed hardware

3.1.29 Test Report FRR-2110/1498

Date of Test:	11.OCT.2021
Identification of Test Body:	Material Lab Testing Services L.L.C., Dubai ILAC (EIAC – Emirates International Accreditation Centre): 008-LB-TEST
Sponsor:	Halspan Limited
Tested Product:	Latched, Single Acting, Double Leaf Doorset with glazing apertures – LSADD.
Tested Orientation:	Opening in towards the furnace
Sampling information:	No sampling report included
Test Standard:	BS 476: Part 20/22: 1987/Amd: 2014
Performance:	Integrity: 66 minutes Insulation: 66 minutes In accordance with clause 7.6 of BS 476: part 22: 1987 the glass has not been evaluated for insulation
Reason for Use	For use as primary evidence for <ul style="list-style-type: none"> • configuration and leaf sizes for Lorient intumescent with a rectangular Beech frame • Steel Bead glazing systems • Hardware Intumescent • Concealed hardware • Flush bolts • Environmental seals

3.1.30 Test Report FRR-2102/4628A

Date of Test:	30.JAN.2021
Identification of Test Body:	Material Lab Testing Services L.L.C., Dubai ILAC (EIAC – Emirates International Accreditation Centre): 008-LB-TEST
Sponsor:	Halspan Limited
Tested Product:	Double Acting, Double Leaf Doorset with Glazed Apertures – DADD. (roller latch engaged)
Tested Orientation:	Doorset opens in both directions, towards and away from the test conditions.
Sampling information:	No sampling report included
Test Standard:	BS 476: Part 20/22: 1987/Amd: 2014
Performance:	Integrity: 73 minutes Insulation: 73 minutes In accordance with clause 7.6 of BS 476: part 22: 1987 the glass has not been evaluated for insulation
Reason for Use	For use as primary evidence for <ul style="list-style-type: none"> • configuration and leaf sizes for Lorient intumescent with a rectangular Beech frame • Feature Grooves • Steel Bead glazing systems • Glazing aperture size • Hardware intumescent • Floor springs • Flush bolts • Push plates and kick plates • Roller catches

3.1.31 Test Report WF193473/A

Date of Test:	01.JUN.2010
Identification of Test Body:	Exova Ltd UKAS No: 0249 (Now trading as: Warringtonfire Testing and Certification Ltd)
Sponsor:	Hoppe (UK) Ltd
Tested Product:	Double Acting, Double Leaf Doorset – DADD.
Tested Orientation:	Doorset opens in both directions, towards and away from the test conditions
Sampling information:	No sampling report included
Test Standard:	BS EN 1634-1:2008
Performance:	<p>Integrity: Sustained flaming: 50 minutes Cotton pad test: 50 minutes Gap gauge: 51 minutes</p> <p>Insulation: Insulation I₂: 50 minutes</p>
Reason for Use	For use as primary evidence for <ul style="list-style-type: none"> • Hardware
Failure Mode:	<p>Initial Failure: Continuous Flaming and Cotton Pad Failure at top of meeting edge at 50 minutes, with area sealed at 51 minutes</p> <p>While failures were observed at the leaf perimeter of the test specimen, the test summarised was undertaken to BS EN 1634-1 which as detailed above is more onerous than BS 476-22 it is therefore the opinion of Warringtonfire that these failures do not contradict the leaf sizes or intumescent specification given herein, though they have not been used to enhance these elements within this assessment.</p>

3.1.32 Test Report BMT/FEP/F14102 A

Date of Test:	08.JUL.2014
Identification of Test Body:	Chiltern International Fire Ltd. UKAS No. 1762 (now trading as Warringtonfire Testing and Certification Limited)
Sponsor:	James Latham
Tested Product:	Doorset A: Unlatched, Single Acting, Double Leaf, Flush timber Doorset with glazing aperture – ULSADD.
Tested Orientation:	Doorset A: Opening in towards the furnace
Sampling information:	No sampling report included
Test Standard:	BS 476: Part 20/22: 1987
Performance:	Integrity: 42 minutes (Doorset A) Insulation: 42 minutes (Doorset A)
Reason for Use	For use as primary evidence for <ul style="list-style-type: none">• Woodex Frames• Hardware The failure has been disregarded with respect to this assessment as the failure was not contributed to the frame material or hardware used within this assessment.
Failure Mode:	Initial Failure: Cotton Pad Test at latch position of Doorset A at 42 minutes No further failure was observed until in excess of 64 minutes of test duration.

3.1.33 Test Report BMT/FEP/F16037

Date of Test:	01.FEB.2016
Identification of Test Body:	Exova Ltd. UKAS No. 1762 (Now trading as: Warringtonfire Testing and Certification Limited)
Sponsor:	James Latham
Tested Product:	Doorset A: Unlatched, Single Acting, Double Leaf Doorset with glazing aperture – ULSADD. Doorset B: Unlatched, Single Acting, Single Leaf Doorset with glazing aperture – ULSASD
Tested Orientation:	Doorset: Opening in towards the furnace Doorset: Opening in towards the furnace
Sampling information:	No sampling report included
Test Standard:	BS 476: Part 20/22: 1987
Performance:	Integrity: Doorset A: 63 minutes Doorset B: 52 minutes Insulation: Doorset A: 63 minutes Doorset B: 52 minutes In accordance with the note to clause 7.6.1.1 of BS 476: Part 22: 1987, the glazing has not been evaluated for insulation
Reason for Use	For use as primary evidence for <ul style="list-style-type: none"> • Woodex Frames • Hardware • Flushbolts • Glazing systems The failure has been disregarded with respect to this assessment as the failure was not contributed to the frame material or hardware used within this assessment.
Failure Mode:	Initial Failure: Continuous flaming at the top closing corner at 52 minutes (Doorset B) No further failures were observed until test termination at 63 minutes.

3.1.34 Test Report WF420277

Date of Test:	15.NOV.2019
Identification of Test Body:	Warringtonfire Testing and Certification Ltd. UKAS No. 1762
Sponsor:	James Latham
Tested Product:	Unlatched, Single Acting, Single Leaf Doorset – ULSASD
Tested Orientation:	Opening in towards the furnace
Sampling information:	No sampling report included
Test Standard:	BS 476: Part 20/22: 1987
Performance:	Integrity: 51 minutes Insulation: 51 minutes
Reason for Use	For use as primary evidence for <ul style="list-style-type: none">• Woodex Frames The frame species utilised within this test has not been used within the scope of this assessment, the test however has been utilised to demonstrate the construction (build up) of frame materials.
Failure Mode:	Initial Failure: Cotton Pad Test at bottom hanging corner at 51 minutes. Further Failure: Cotton Pad Test at bottom hinge position at 65 minutes Further Failure: Continuous Flaming at top hanging corner and top hanging edge at 65 minutes

3.1.35 Test Report RF0006A

Date of Test:	14.JAN.2000
Identification of Test Body:	Chiltern International Fire UKAS No. 1762 (Now trading as Warringtonfire Testing and Certification Limited)
Sponsor:	Halspan Ltd
Tested Product:	Unlatched, Single Acting, Single Leaf Doorset – ULSASD.
Tested Orientation:	Opening in towards the furnace
Sampling information:	No sampling report included
Test Standard:	BS 476: Part 22: 1987
Performance:	Integrity: 60 minutes Insulation: 60 minutes
Reason for Use	For use as primary evidence for: <ul style="list-style-type: none">• Comparative testing for supporting Woodex frame• Comparative testing carried out with Lorient Palusol intumescent seals.• Glazing systems

3.1.36 Test Report RF06005

Date of Test:	04.APR.2006
Identification of Test Body:	Chiltern International Fire UKAS No. 1762 (Now trading as Warringtonfire Testing and Certification Limited)
Sponsor:	Halspan Ltd
Tested Product:	Doorset A and B: Unlatched, Single Acting, Single Leaf Doorset – ULSASD.
Tested Orientation:	Doorset A: Opening in towards the furnace Doorset B: Opening in towards the furnace
Sampling information:	No sampling report included
Test Standard:	BS 476: Part 22: 1987
Performance:	Integrity: Doorset A: 75 minutes Doorset B: 75 minutes Insulation: Doorset A: 75 minutes Doorset B: 75 minutes
Reason for Use	For use as primary evidence for: <ul style="list-style-type: none">• Comparative testing for supporting Woodex frame• Comparative testing carried out with Lorient Palusol intumescent seals.

3.1.37 Test Report WF508668

Date of Test:	14.OCT.2021
Identification of Test Body:	Warringtonfire Testing and Certification Ltd. UKAS No. 1762
Sponsor:	Halspan Limited
Tested Product:	Doorset A and B: Latched, Single Acting, Single Leaf Doorsets with glazing apertures – LSASD
Tested Orientation:	Doorset A: Opening away from the furnace Doorset B: Opening in towards the furnace
Sampling information:	BM Trada, SC21165, 12 th October 2021
Test Standard:	BS EN 1634-1:2014+A1:2018
Performance:	<p>Integrity: Doorset A: Sustained flaming: 74 minutes Cotton pad test: 74 minutes Gap gauge: 74 minutes Doorset B: Sustained flaming: 62 minutes Cotton pad test: 74 minutes Gap gauge: 74 minutes</p> <p>Insulation: Doorset A: Insulation I₂: 74 minutes Doorset B: Insulation I₂: 62 minutes</p>
Reason for Use	For use as primary evidence for <ul style="list-style-type: none"> • Shadow gaps • Orientation of doorset opening towards and away from the fire risk • Glazing systems • Hardware Intumescent • Hardware • Cable loops

3.1.38 Test Report WF507673

Date of Test:	11.NOV.2021
Identification of Test Body:	Warringtonfire Testing and Certification Ltd. UKAS No. 1762
Sponsor:	Halspan Limited
Tested Product:	Latched, Single Acting, Double Leaf Doorset – LSADD.
Tested Orientation:	Opening in towards the furnace
Sampling information:	BM Trada, SC21138, 10 th September 2021
Test Standard:	BS EN 1634-1:2014+A1:2018
Performance:	<p>Integrity: Sustained flaming: 49 minutes Cotton pad test: 61 minutes Gap gauge: 61 minutes</p> <p>Insulation: Insulation I₂: 49 minutes</p>
Reason for Use	<p>For use as primary evidence for</p> <ul style="list-style-type: none"> 4-sided frames <p>The failures at the leaf perimeter have been considered to be due to bending of the partition and assessment is made to reducing the height above the floor and limiting the permitted leaf height.</p>
Failure Mode:	<p>Initial Failure: Continuous Flaming at meeting edge latch position at 49 minutes Further Failure: Continuous flaming at top hanging corner of primary leaf at 52 minutes Further Failure: Continuous flaming at top hanging corner of secondary leaf at 58 minutes Further Failure: Continuous flaming at top meeting edge at 59 minutes</p>

3.1.39 Test Report WF508198

Date of Test:	15.SEP.2021
Identification of Test Body:	Warringtonfire testing and certification Ltd. UKAS No. 1762
Sponsor:	Woodmarque Ltd
Tested Product:	Latched, Single Acting, Double Leaf Doorset with glazing apertures – LSADD
Tested Orientation:	Opening in towards the furnace
Sampling information:	No sampling report included
Test Standard:	BS EN 1634-1:2014+A1:2018
Performance:	<p>Integrity: Sustained flaming: 56 minutes Cotton pad test: 65 minutes Gap gauge: 65 minutes</p> <p>Insulation: Insulation I₂: 56 minutes</p>
Reason for Use	<p>For use as primary evidence for</p> <ul style="list-style-type: none"> • Shadow gaps installation • Hardware • Jamb concealed closer • Ansi Bolt <p>The 56-minute integrity failure at the glazing has been ignored as the glass and glazing system used within the test has not been included within this assessment.</p>
Failure Mode:	<p>Initial Failure: Continuous Flaming at right leaf glazing at 56 minutes Further Failure: Glazing fracture on left leaf at 57 minutes. Right leaf glazing boarded up at 57 minutes, left leaf glazing boarded up at 58 minutes. No further failure was observed until in excess of 64 minutes of test duration.</p>

3.1.40 Test Report Chilt/RF08035

Date of Test:	13.MAR.2008
Identification of Test Body:	Chiltern International Fire UKAS No. 1762 (Now trading as Warringtonfire Testing and Certification Limited)
Sponsor:	Halspan Ltd
Tested Product:	Unlatched, Single Acting, Double Leaf Doorset – ULSADD.
Tested Orientation:	Opening in towards the furnace
Sampling information:	No sampling report included
Test Standard:	BS 476: Part 22: 1987
Performance:	Integrity: Integrity: 64 minutes Insulation: Insulation: 64 minutes
Reason for Use	For use as primary evidence for <ul style="list-style-type: none">• configuration and leaf sizes for Halspan intumescent with a rectangular hardwood frame• PVC lippings

3.1.41 Test Report WF331430 Issue 3 B

Date of Test:	22.JUL.2013
Identification of Test Body:	Exova Ltd UKAS No: 0249 (Now trading as Warringtonfire Testing and Certification Ltd)
Sponsor:	Hoppe (UK) Ltd
Tested Product:	Doorset B: Unlatched, Single Acting, Single Leaf, Flush timber Doorset – ULSASD
Tested Orientation:	Opening away from the furnace
Sampling information:	The hardware was independently sample selected from the manufacturer's premises by a representative of Warrington Certification Ltd. No sampling report included.
Test Standard:	BS EN 1634-1:2008
Performance:	Integrity: Sustained flaming: 66 minutes Cotton pad test: 66 minutes Gap gauge: 66 minutes Insulation: Insulation I ₂ : 66 minutes
Reason for Use	For use as primary evidence for <ul style="list-style-type: none">• Hardware

3.1.42 Test Report CFR2203091

Date of Test:	10.MAR.2022
Identification of Test Body:	Cambridge Fire Research Ltd. UKAS No. 4319
Sponsor:	Halspan Limited
Tested Product:	Unlatched, Single Acting, Double Leaf Doorset with glazing apertures, fanlights and sidelights – ULSADD
Tested Orientation:	Opening towards the furnace
Sampling information:	BM Trada, SC22016, 1 st and 4 th March 2022
Test Standard:	BS EN 1634-1:2014+A1:2018
Performance:	<p>Integrity: Sustained flaming: 60 minutes Cotton pad test: 67 minutes Gap gauge: 67 minutes</p> <p>Insulation: Insulation I₂: 36 minutes</p>
Reason for Use	<p>For use as primary evidence for</p> <ul style="list-style-type: none"> • Halspan SLS Glazing Systems • Overpanels • Fanlights • Sidepanels • Sidelights • Glazing systems

3.1.43 Test Report CFR1909241 Revision 1

Date of Test:	24.SEP.2019
Identification of Test Body:	Cambridge Fire Research Ltd. UKAS No. 4319
Sponsor:	Halspan Limited
Tested Product:	Latched, Single Acting, Double Leaf Doorset with glazing apertures – LSADD
Tested Orientation:	Opening in towards the furnace
Sampling information:	BM Trada, PS181201, 17 th December 2018
Test Standard:	BS EN 1634-1:2014+A1:2018
Performance:	<p>Integrity: Sustained flaming: 63 minutes Cotton pad test: 31 minutes Gap gauge: 68 minutes</p> <p>Insulation: Insulation I₂: 14 minutes</p>
Reason for Use	<p>For use as primary evidence for</p> <ul style="list-style-type: none"> • Glass and glazing systems • Hardware Intumescent • Hardware • Concealed hardware • Flushbolt • Hygeno IntaVista & FlushView glazing units <p>This report is an evaluation of the potential fire resistance performance if the design were to be tested in accordance with BS 476: Part 22: 1987. If tested to BS 476: Part 22: 1987, a cotton pad test would not normally be applied to the non-insulating elements of a doorset design and therefore the initial failure times are not considered relevant when used for this purpose.</p>
Failure Mode:	<p>Initial Failure: Cotton Pad Failure at left-hand glazing at 31 minutes Further Failure: Cotton Pad Failure at right-hand glazing at 43 minutes No further failure was observed until in excess of 62 minutes of test duration.</p>

3.1.44 Test Report WF385622 AR1

Date of Test:	28.JUL.2017
Identification of Test Body:	Exova Ltd UKAS No. 1762 (Now trading as: Warringtonfire Testing and Certification Ltd)
Sponsor:	Halspan Ltd
Tested Product:	Unlatched, Single Acting, Double Leaf Doorset with glazed apertures – ULSADD.
Tested Orientation:	Opening in towards the furnace
Sampling information:	No sampling report included
Test Standard:	BS 476: Part 20/22: 1987
Performance:	Integrity: 64 minutes Insulation: 64 minutes In accordance with the note to clause 7.6.1.1 of BS 476: part 22: 1987, the glazing has not been evaluated for insulation
Reason for Use	For use as primary evidence for <ul style="list-style-type: none">• Hardware• Glazing systems

3.1.45 Test Report WF520064

Date of Test:	13.OCT.2022
Identification of Test Body:	Warringtonfire Testing and Certification Ltd. UKAS No 1762
Sponsor:	Halspan Ltd
Tested Product:	Doorset A: Latched, Single Acting, Single Leaf Doorset with glazed aperture – LSASD Doorset B: Latched, Single Acting, Single Leaf Doorset with glazed aperture – LSASD
Tested Orientation:	Doorset A: Opening away from the furnace Doorset B: Opening in towards the furnace
Sampling information:	BM Trada, SC22149, 26 th & 27 th September & 3 rd October 2022
Test Standard:	BS EN 1634-1:2014+A1:2018
Performance:	<p>Integrity: Doorset A: Sustained flaming: 72 minutes Cotton pad test: 72 minutes Gap gauge: 72 minutes Doorset B: Sustained flaming: 70 minutes Cotton pad test: 71 minutes Gap gauge: 72 minutes</p> <p>Insulation: Doorset A: Insulation: 42 minutes Doorset B: Insulation: 37 minutes</p>
Reason for Use	For use as primary evidence for <ul style="list-style-type: none"> • Access control systems • Hardware • Tracker tags • Glazing systems

3.1.46 Test Report CFR1509291

Date of Test:	29.SEP.2015
Identification of Test Body:	Cambridge Fire Research Ltd. UKAS No. 4319
Sponsor:	Halspan Limited
Tested Product:	Unlatched, Single Acting, Single Leaf Doorset with glazed apertures – ULSASD.
Tested Orientation:	Opening in towards the furnace
Sampling information:	No sampling report included
Test Standard:	BS 476: Part 22: 1987
Performance:	Integrity: Integrity: 68 minutes Insulation: Insulation: 65 minutes
Reason for Use	For use as primary evidence for <ul style="list-style-type: none">• Glazing systems• Hardware intumescent• Hardware

3.1.47 Test Report WF507664

Date of Test:	08.SEP.2021
Identification of Test Body:	Warringtonfire Testing and Certification Ltd. UKAS No. 1762
Sponsor:	Halspan Limited
Tested Product:	Doorset A: Latched, Single Acting, Single Leaf Doorset with, glazing apertures – LSASD. Doorset B: Latched, Single Acting, Single Leaf Doorset with glazing apertures – LSASD
Tested Orientation:	Doorset A: Opens away from the furnace Doorset B: Opens in towards the furnace
Sampling information:	BM Trada, SC21146, 31 st August 2021
Test Standard:	BS EN 1634-1:2014+A1:2018
Performance:	<p>Integrity: Doorset A: Sustained flaming: 60 minutes Cotton pad test: 55 minutes Gap gauge: 61 minutes Doorset B: Sustained flaming: 49 minutes Cotton pad test: 49 minutes Gap gauge: 61 minutes</p> <p>Insulation: Doorset A: Insulation I₂: 53 minutes Doorset B: Insulation I₂: 45 minutes</p>
Reason for Use	For use as primary evidence for <ul style="list-style-type: none"> • Hardware • Glazing systems
Failure Mode:	While failures were observed at the leaf perimeter of both test specimens, the test summarised was undertaken to BS EN 1634-1 which as detailed above is more onerous than BS 476-22 it is therefore the opinion of Warringtonfire that these failures do not contradict the leaf sizes or intumescent specification given herein, though they have not been used to enhance these elements within this assessment. There were no failures associated with the glazing apertures at the test termination at 61 minutes therefore, these items have been included.

3.1.48 Test Report WF523824/R

Date of Test:	24.OCT.2022
Identification of Test Body:	Warringtonfire Testing and Certification Ltd. UKAS No 0249
Sponsor:	Halspan Limited
Tested Product:	Doorset A: Latched, Single Acting, Single Leaf Doorset with glazed aperture – LSASD Doorset B: Latched, Single Acting, Single Leaf Doorset with glazed aperture – LSASD
Tested Orientation:	Doorset A: Opening towards the furnace Doorset B: Opening away from the furnace
Sampling information:	BM Trada, SC22212, 20 th October 2022
Test Standard:	BS EN 1634-1:2014+A1:2018
Performance:	<p>Integrity: Doorset A: Sustained flaming: 63 minutes Cotton pad test: 63 minutes Gap gauge: 63 minutes Doorset B: Sustained flaming: 63 minutes Cotton pad test: 63 minutes Gap gauge: 63 minutes</p> <p>Insulation: Doorset A: Insulation I₂: 19 minutes Doorset B: Insulation I₂: 19 minutes</p>
Reason for Use	For use as primary evidence for <ul style="list-style-type: none"> • Hardware • Electronic locking • Concealed closer • Cable loops • Cableways • Tracker tags

3.1.49 Test Report WF515598/LR

Date of Test:	01.JUL.2022
Identification of Test Body:	Warringtonfire Testing and Certification Ltd.
Sponsor:	Pyroguard UK Ltd
Tested Product:	Single glazing in a timber door blank
Tested Orientation:	Not applicable
Sampling information:	Warringtonfire, FM517023-3, 4 th April 2022
Test Standard:	General principals of BS 476-20 1987
Performance:	Integrity: 65 minutes Insulation: Not evaluated
Reason for Use	For use as primary evidence for <ul style="list-style-type: none">• Glazing systems

3.1.50 Test Report WF517609/LR

Date of Test:	05.MAY.2022
Identification of Test Body:	Warringtonfire Testing and Certification Ltd.
Sponsor:	Pyroguard UK Ltd
Tested Product:	Single glazing in a timber door blank
Tested Orientation:	Not applicable
Sampling information:	Warringtonfire, FM516511-5, 30 th March 2022
Test Standard:	General principals of BS 476-20 1987
Performance:	Integrity: 90 minutes Insulation: Not evaluated
Reason for Use	For use as primary evidence for <ul style="list-style-type: none">• Glazing systems

3.1.51 Test Report WF515592/LR

Date of Test:	06.MAY.2022
Identification of Test Body:	Warringtonfire Testing and Certification Ltd.
Sponsor:	Pyroguard UK Ltd
Tested Product:	Single glazing in a timber door blank
Tested Orientation:	Not applicable
Sampling information:	Warringtonfire, FM517023-2, 4 th April 2022
Test Standard:	General principals of BS 476-20 1987
Performance:	Integrity: 66 minutes Insulation: Not evaluated
Reason for Use	For use as primary evidence for <ul style="list-style-type: none">• Glazing systems

3.1.52 Test Report WF512028/LR Issue 2

Date of Test:	16.DEC.2021
Identification of Test Body:	Warringtonfire Testing and Certification Ltd.
Sponsor:	Pyroguard UK Ltd
Tested Product:	Single glazing in a timber door blank
Tested Orientation:	Not applicable
Sampling information:	Warringtonfire, FM507754-1, 20 th August 2021
Test Standard:	General principals of BS 476-20 1987
Performance:	Integrity: 90 minutes Insulation: Not evaluated
Reason for Use	For use as primary evidence for <ul style="list-style-type: none">• Glazing systems

3.1.53 Test Report FRR-2107/2288

Date of Test:	16.AUG.2021
Identification of Test Body:	Material Lab Testing Services L.L.C., Dubai ILAC (EIAC – Emirates International Accreditation Centre): 008-LB-TEST
Sponsor:	Halspan Limited
Tested Product:	Latched, Double Egress, Double Leaf, Flush timber Doorset with glazing apertures.
Tested Orientation:	Doorset opens in both directions, one leaf towards and one leaf away from the test conditions.
Sampling information:	No sampling report included
Test Standard:	BS 476: Part 20/22: 1987/Amd: 2014
Performance:	Integrity: 61 minutes Insulation: 61 minutes In accordance with clause 7.6 of BS 476: part 22: 1987 the glass has not been evaluated for insulation
Reason for Use	For use as primary evidence for <ul style="list-style-type: none">• Glazing systems• Hardware

3.1.54 Test Report WF189639 A & B

Date of Test:	17.FEB.2010
Identification of Test Body:	Exova Warringtonfire UKAS No. 0249 (now trading as: Warringtonfire Testing and Certification Ltd)
Sponsor:	Dorma UK Ltd
Tested Product:	Doorset A: Latched, Single Acting, Single Leaf Doorset – LSASD. Doorset B: Latched, Single Acting, Single Leaf Doorset – LSASD.
Tested Orientation:	Opening away from furnace
Sampling information:	No sampling report included
Test Standard:	BS EN 1634-1:2008
Performance:	<p>Integrity: Doorset A: Sustained flaming: 66 minutes Cotton pad test: 66 minutes Gap gauge: 66 minutes Doorset B: Sustained flaming: 66 minutes Cotton pad test: 66 minutes Gap gauge: 66 minutes</p> <p>Insulation: Doorset A: 66 minutes Doorset B: 66 minutes</p>
Reason for Use	For use as primary evidence for <ul style="list-style-type: none"> • Hardware • Electronic locking

3.1.55 Test Report BMT/FEP/PF15288 Revision A

Date of Test	9.NOV.2015
Identification of Test Body	Exova Warringtonfire UKAS No. 1762 (now trading as: Warringtonfire Testing and Certification Ltd)
Sponsor	Sealed Tight Solutions
Tested Product	Doorset A: Unlatched, Single Acting, Single Leaf Doorset with Glazing – ULSADD
Tested Orientation	Opening in towards heating condition
Sampling information:	No sampling report included
Test Standard	BS 476: Part 22:1987
Performance	Integrity: 44 minutes Insulation: 0 minutes In accordance with clause 8.6 of BS 476: part 22: 1987 the doorset has not been evaluated for insulation
Reason for Use	For use as primary evidence for <ul style="list-style-type: none">• Glazing The integrity failure due to the installation of the door frame (sealing to the structure) for a doorset design which is different to the one detailed within this assessment. As the failure modes prior to 60 minutes duration are remote from the glazing. This report supports the use of the STS systems considered within this report.
Failure Mode	Initial integrity failure was recorded at 44 minutes between the back of frame and structural opening, a further leaf edge failure was recorded at 77 minutes. No failures in the area of the glazed aperture were recorded prior to the door being boarded over at 80 minutes into the test.

3.1.56 Test Report BMT/FEP/PF15035

Date of Test	10.FEB.2015
Identification of Test Body	BM TRADA UKAS No. 1762 (Now trading as Warringtonfire Testing and Certification Limited)
Sponsor	Sealed Tight Solutions Ltd
Tested Product	Unlatched, Single Acting, Double Leaf Doorset with Glazing – ULSADD
Tested Orientation	Opening in towards heating condition
Sampling information:	No sampling report included
Test Standard:	BS 476: Part 22: 1987
Performance	<p>Integrity: 50 minutes Insulation: 0 minutes</p> <p>In accordance with clause 8.6 of BS 476: part 22: 1987 the doorset has not been evaluated for insulation</p>
Reason for Use	<p>For use as primary evidence for:</p> <ul style="list-style-type: none"> • configuration and leaf sizes for Lorient intumescent with a rectangular MDF frame, fitted flush with the supporting construction. • Hardware • Glazing <p>The integrity failure observed is specifically related to a doorset design which is different to the one detailed within this assessment. As the failure modes prior to 60 minutes duration are remote from the glazing. This report supports the use of the STS systems considered within this report.</p>
Failure Mode	Initial failure recorded at the leaf meeting edges, further failure at the left leaf top hanging corner by cotton pad and again by means of continuous flaming in the same location. No failure was observed at the glazing of the leaves until 63 minutes of test duration.

3.1.57 Test Report CFR2105131

Date of Test:	13.MAY.2021
Identification of Test Body:	Cambridge Fire Research Ltd. UKAS No. 4319
Sponsor:	Halspan Limited
Tested Product:	2No. Latched, Single Acting, Single Leaf Doorsets with 1No. Glazed Aperture – LSASD within a single aperture
Tested Orientation:	Opening in towards the furnace
Sampling information:	BM Trada, SC21043, 06 th and 10 th May 2021
Test Standard:	BS EN 1634-1:2014+A1:2018
Performance:	<p>Integrity: Sustained flaming: 58 minutes Cotton pad test: 57 minutes Gap gauge: 68 minutes</p> <p>Insulation: Insulation I₂: 46 minutes</p>
Reason for Use	<p>For use as primary evidence for:</p> <ul style="list-style-type: none"> • Hardware • Aluminium threshold <p>The integrity failures observed are specifically related to a doorset design which is different to the one detailed within this assessment. As the failure modes prior to 60 minutes duration are remote from the items being considered herein it has been deemed suitable evidence to support their use.</p>
Failure Mode:	Initial Failure: Cotton Pad Test at RH Letterplate at 57 minutes

3.1.58 Test Report CFR2007291 Revision 1

Date of Test:	29.JULY.2020
Identification of Test Body:	Cambridge Fire Research Ltd. UKAS No. 4319
Sponsor:	Halspan Limited
Tested Product:	Double Acting, Double Leaf, Glazed Apertures – DADD.
Tested Orientation:	Doorset opens in both directions, towards and away from the test conditions.
Sampling information:	BM Trada, SC20126, 23 rd July 2020
Test Standard:	BS EN 1634-1:2014+A1:2018
Performance:	Integrity: Sustained Flaming: 60 minutes Cotton pad test: 61 minutes Gap gauge: 61 minutes Insulation: Insulation I ₂ : 38 minutes
Reason for Use	For use as primary evidence for: <ul style="list-style-type: none">• Electronic locking• Pivots• Concealed closer• Glazing systems

3.1.59 Test Report WF390174

Date of Test:	18.OCT.2017
Identification of Test Body:	Exova Ltd. UKAS No. 0249 (now trading under: Warringtonfire Test & Certification)
Sponsor:	Dorma UK Ltd
Tested Product:	Doorset A: Latched, Single Acting, Single Leaf Doorset– LSASD. Doorset B: Latched, Single Acting, Single Leaf Doorset - LSASD
Tested Orientation:	Doorset A: Opening away from the furnace Doorset B: Opening away from the furnace
Sampling information:	Warrington Certification, FM388953, 13 th September 2017 selection of hardware items
Test Standard:	BS EN 1634-1:2014
Performance:	<p>Integrity: Doorset A: Sustained flaming: 63 minutes Cotton pad test: 63 minutes Gap gauge: 67 minutes Doorset B: Sustained flaming: 38 minutes Cotton pad test: 38 minutes Gap gauge: 67 minutes</p> <p>Insulation I₂: Doorset A: 63 minutes Doorset B: 38 minutes</p>
Reason for Use	<p>For use as primary evidence for</p> <ul style="list-style-type: none"> • Hardware • Pull handles • Panic hardware <p>The integrity failures observed on doorset B were local to a specific item of building hardware which has not been included herein. Further to this failure no other failures were observed and therefore this report is suitable for other items being included within this report.</p>
Failure Mode:	Initial Failure: Cotton Pad Test and Continuous Flaming at wide panic module at 38 minutes (Doorset B).

3.1.60 Test Report WF379041A Issue 3

Date of Test:	31.JAN.2017
Identification of Test Body:	Exova UKAS No. 0249 (Now trading under: Warringtonfire Testing and Certification)
Sponsor:	Dorma Deutschland Gmbh
Tested Product:	Double Acting, Single Leaf Doorset – DASD.
Tested Orientation:	Doorset opens in both directions, towards and away from the test conditions.
Sampling information:	Warrington Certification, FM378235, 16 th January 2017 selected items of hardware
Test Standard:	BS EN 1634-1:2014
Performance:	Integrity: Sustained flaming: 64 minutes Cotton pad test: 64 minutes Gap gauge: 64 minutes Insulation: Insulation I ₂ : 64 minutes
Reason for Use	For use as primary evidence for <ul style="list-style-type: none">• Floor spring

3.1.61 Test Report WF379041B Issue 3

Date of Test:	31.JAN.2017
Identification of Test Body:	Exova Ltd. UKAS No. 0249 (Now trading under: Warringtonfire Testing and Certification)
Sponsor:	Dorma Deutschland Gmbh
Tested Product:	Unlatched, Single acting, Single leaf Doorset - ULSASD
Tested Orientation:	Opening towards the furnace
Sampling information:	Warrington Certification, FM378235, 16 th January 2017 selected items of hardware
Test Standard:	BS EN 1634-1:2014
Performance:	<p>Integrity: Sustained flaming: 58 minutes Cotton pad test: 58 minutes Gap gauge: 64 minutes</p> <p>Insulation: Insulation I₂: 58 minutes</p>
Reason for Use	<p>For use as primary evidence for</p> <ul style="list-style-type: none"> • Hardware Intumescent • Concealed overhead closer <p>The failure observed has been identified to have originated from the lock position. The lock has not been included within this assessment.</p>
Failure Mode:	Initial Failure: Continuous Flaming around the lockset at 58 minutes

3.1.62 Test Report WF379042

Date of Test:	08.FEB.2017
Identification of Test Body:	Exova Ltd UKAS No. 0249 (Now trading under: Warringtonfire Testing and Certification)
Sponsor:	Dormakaba.
Tested Product:	Doorset A: Unlatched, Single Acting, Single Leaf Doorset – ULSASD. Doorset B: Unlatched, Single Acting, Single Leaf Doorset - ULSASD
Tested Orientation:	Doorset A: Opening away from the furnace Doorset B: Opening towards the furnace
Sampling information:	Warrington Certification, FM378235, 16 th January 2017 selected items of hardware
Test Standard:	BS EN 1634-1:2014
Performance:	<p>Integrity: Doorset A: Sustained flaming: 64 minutes Cotton pad test: 64 minutes Gap gauge: 64 minutes Doorset B: Sustained flaming: 63 minutes Cotton pad test: 63 minutes Gap gauge: 64 minutes</p> <p>Insulation I₂: Doorset A: 64 minutes Doorset B: 63 minutes</p>
Reason for Use	For use as primary evidence for <ul style="list-style-type: none"> • Access control systems • Hardware • Concealed overhead closer

3.1.63 Test Report WF350451

Date of Test:	14.APRIL.2015
Identification of Test Body:	Exova Ltd UKAS No. 0249 (Now trading as: Warringtonfire Testing and Certification Ltd)
Sponsor:	Dorma Deutschland GmbH
Tested Product:	Doorset A: Unlatched, Single Acting, Single Leaf Doorset– ULSASD. Doorset B: Latched, Single Acting, Single Leaf doorset – LSASD
Tested Orientation:	Doorset A: Opening towards the furnace Doorset B: Opening towards the furnace
Sampling information:	A representative of Warrington Certification Limited sample selected the concealed door closer on Doorset A and the hinges from a larger batch provided by the manufacturer. A representative of MPA sample selected the SVP components on both doorsets. No sampling report included.
Test Standard:	BS EN 1634-1:2014
Performance:	<p>Integrity: Doorset A: Sustained flaming: 60 minutes Cotton pad test: 60 minutes Gap gauge: 63 minutes Doorset B: Sustained flaming: 53 minutes Cotton pad test: 52 minutes Gap gauge: 63 minutes</p> <p>Insulation I₂: Doorset A: 60 minutes Doorset B: 52 minutes</p>
Reason for Use	<p>For use as primary evidence for</p> <ul style="list-style-type: none"> • Hardware • Concealed overhead closer <p>While failures were observed at the leaf perimeter of Doorset B, the test summarised was undertaken to BS EN 1634-1 which as detailed above is more onerous than BS 476-22. It is therefore the opinion of Warringtonfire that these failures do not contradict the scope given herein.</p>
Failure Mode:	<p>Initial Failure: Cotton Pad Test at top corner leading edge at 52 minutes (Doorset B) Further Failure: Continuous Flaming along the head at 53 minutes (Doorset B)</p>

3.1.64 Test Report WF198681

Date of Test:	09.DEC.2010
Identification of Test Body:	Exova Ltd. UKAS No. 0249 (Now trading under: Warringtonfire Testing and Certification)
Sponsor:	Dorma UK Ltd
Tested Product:	Doorset A: Double Acting, Single Leaf Doorset – DASD. Doorset B: Latched, Single Acting, Single Leaf Doorset - LSASD
Tested Orientation:	Doorset A: Doorset opens in both directions, towards and away from the test conditions. Doorset B: opening away from the furnace
Sampling information:	No sampling report included
Test Standard:	BS EN 1634-1:2008
Performance:	<p>Integrity: Doorset A: Sustained flaming: 33 minutes Cotton pad test: 33 minutes Gap gauge: 33 minutes Doorset B: Sustained flaming: 64 minutes Cotton pad test: 64 minutes Gap gauge: 65 minutes</p> <p>Insulation I₂: Doorset A: 33 minutes Doorset B: 64 minutes</p>
Reason for Use	<p>For use as primary evidence for</p> <ul style="list-style-type: none"> • Panic Hardware • Roller catches • Hardware intumescent • Hardware <p>While failures were observed at the leaf perimeter of Doorset A, the test summarised was undertaken to BS EN 1634-1 which as detailed above is more onerous than BS 476-22 it is therefore the opinion of Warringtonfire that these failures do not contradict the scope given herein.</p>
Failure Mode:	Initial Failure: Cotton Pad Test and Continuous Flaming at head of Doorset A at 33 minutes

3.1.65 Test Report WF513979

Date of Test:	03.MAR.2022
Identification of Test Body:	Warringtonfire Testing and Certification Ltd. UKAS No. 1762
Sponsor:	Dormakaba UK Ltd
Tested Product:	Doorset A: Unlatched, Single Acting, Single Leaf Doorset – ULSASD. Doorset B: Unlatched, Single Acting, Single Leaf Doorset – ULSASD
Tested Orientation:	Doorset A: Opening towards the furnace Doorset B: Opening away from the furnace
Sampling information:	Warringtonfire Testing and Certification Ltd FM511216 27 th January 2022 of hardware items
Test Standard:	BS EN 1634-1:2014+A1:2018
Performance:	Integrity: Doorset A: 74minutes Doorset B: 74 minutes Insulation I₂: Doorset A: 74minutes Doorset B: 74 minutes
Reason for Use	For use as primary evidence for <ul style="list-style-type: none">• Hardware• Panic hardware• Overhead door operator• Sensors

3.1.66 Test Report WF323822

Date of Test:	07.DEC.2012
Identification of Test Body:	Exova Ltd. UKAS No.: 0249 (Now trading as: Warringtonfire Testing and Certification)
Sponsor:	Bartels Systembeschlage Gmbh and Cooke Brothers Ltd
Tested Product:	Doorset A: Unlatched, Single Acting, Single Leaf Doorset – ULSASD. Doorset B: Unlatched, Single Acting, Single Leaf Doorset- ULSASD
Tested Orientation:	Doorset A: Opening towards the furnace Doorset B: Opening towards the furnace
Sampling information:	No sampling report included
Test Standard:	BS EN 1634-1:2008
Performance:	<p>Integrity: Doorset A: Sustained flaming: 63 minutes Cotton pad test: 61 minutes Gap gauge: 66 minutes Doorset B: Sustained flaming: 64 minutes Cotton pad test: 64 minutes Gap gauge: 66 minutes</p> <p>Insulation I₂: Doorset A: 61minutes Doorset B: 64 minutes</p>
Reason for Use	For use as primary evidence for <ul style="list-style-type: none"> • Concealed hinge • Hardware

3.1.67 Test Report CFR1711241 LH

Date of Test:	24.NOV.2017
Identification of Test Body:	Cambridge Fire Research Ltd, UKAS No: 4319
Sponsor:	Royde and Tucker Ltd
Tested Product:	Doorset LH: Unlatched, Single Acting, Single Leaf Doorset – ULSASD.
Tested Orientation:	Doorset LH: Opening towards the furnace
Sampling information:	No sampling report included
Test Standard:	BS EN 1634-1:2014
Performance:	Integrity: Sustained flaming: 68 minutes Cotton pad test: 68 minutes Gap gauge: 68 minutes Insulation I₂: 68 minutes
Reason for Use	For use as primary evidence for <ul style="list-style-type: none"> • Concealed hinge • Hardware

3.1.68 Test Report CFR1811211 LH

Date of Test:	21.NOV.2018
Identification of Test Body:	Cambridge Fire Research Ltd. UKAS No. 4319
Sponsor:	Royde and Tucker Ltd
Tested Product:	Doorset LH: Unlatched, Single Acting, Single Leaf Doorset – ULSASD.
Tested Orientation:	Doorset LH: Opening towards the furnace
Sampling information:	FM406927, 14 th November 2018 – Hinges FM395802, 16 th October 2018 – Letterplate with cowl
Test Standard:	BS EN 1634-1:2014+A1:2018
Performance:	Integrity: Sustained flaming: 63 minutes Cotton pad test: 62 minutes Gap gauge: 68 minutes Insulation I₂: 62 minutes
Reason for Use	For use as primary evidence for <ul style="list-style-type: none"> • Hardware

3.1.69 Test Report WF380315B

Date of Test:	28.FEB.2017
Identification of Test Body:	Exova Ltd UKAS No: 0249 (Now Trading Under: Warringtonfire testing and certification)
Sponsor:	Hoppe (UK) Limited
Tested Product:	Doorset B: Unlatched, Single Acting, Single Leaf Doorset – ULSASD
Tested Orientation:	Doorset B: Opening towards the furnace
Sampling information:	No sampling report included
Test Standard:	BS EN 1634-1:2014
Performance:	<p>Integrity: Sustained flaming: 47 minutes Cotton pad test: 47 minutes Gap gauge: 47 minutes Insulation I₂: 47 minutes</p>
Reason for Use	<p>For use as primary evidence for</p> <ul style="list-style-type: none"> • Hardware • Security viewer <p>While failures were observed at the leaf perimeter of Doorset B, the test summarised was undertaken to BS EN 1634-1 which as detailed above is more onerous than BS 476-22. It is therefore the opinion of Warringtonfire that these failures do not contradict the scope given herein.</p>
Failure Mode:	Initial Failure: Continuous Flaming at localised spot at head of Doorset B leaf at 47 minutes

3.1.70 Test Report WF364240 Issue 2

Date of Test:	11.MAY.2016
Identification of Test Body:	Exova Ltd UKAS No. 0249 (Now trading as: Warringtonfire testing and certification)
Sponsor:	Abloy OY.
Tested Product:	Doorset A: Latched, Single Acting, Single Leaf, Doorset – LSASD Doorset B: Latched, Single Acting, Single Leaf Doorset – LSASD
Tested Orientation:	Doorset A: Opening towards furnace Doorset B: Opening away from furnace
Sampling information:	Warrington Certification, WF362341, 26 th April 2016; 9No. sample reports for hardware items
Test Standard:	BS EN 1634-1:2014
Performance:	<p>Integrity: Doorset A: Sustained flaming: 68 minutes Cotton pad test: 68 minutes Gap gauge: 68 minutes Doorset B: Sustained flaming: 68 minutes Cotton pad test: 68 minutes Gap gauge: 68 minutes</p> <p>Insulation I₂: Doorset A: 68minutes Doorset B: 68 minutes</p>
Reason for Use	For use as primary evidence for <ul style="list-style-type: none"> • Hardware • Cable loops

3.1.71 Test Report WF367907

Date of Test:	10.JULY.2016
Identification of Test Body:	Exova Ltd UKAS No. 0249 (Now trading as: Warringtonfire testing and certification)
Sponsor:	ASSA Abloy Hospitality Limited
Tested Product:	Doorset A: Latched, Single Acting, Single Leaf Doorset – LSASD. Doorset B: Latched, Single Acting, Single Leaf Doorset – LSASD
Tested Orientation:	Doorset A: Opening away from the furnace Doorset B: Opening towards the furnace
Sampling information:	Warrington Certification, WCL Job No. 364075, 20 th June 2016
Test Standard:	BS EN 1634-1:2014
Performance:	<p>Integrity: Doorset A: Sustained flaming: 62 minutes Cotton pad test: 62 minutes Gap gauge: 65 minutes Doorset B: Sustained flaming: 65 minutes Cotton pad test: 65 minutes Gap gauge: 65 minutes</p> <p>Insulation I₂: Doorset A: 62minutes Doorset B: 65 minutes</p>
Reason for Use	For use as primary evidence for <ul style="list-style-type: none"> • Access control systems

3.1.72 Test Report BMT/FEP/F14095

Date of Test:	27.JUN.2014
Identification of Test Body:	BM TRADA UKAS No. 1762 (Now trading as Warringtonfire Testing and Certification Limited)
Sponsor:	Newstar Door Controls Ltd
Tested Product:	Doorset A: Latched, Single Acting, Double Leaf Doorset – LSADD Doorset B: Latched, Single Acting, Single Leaf Doorset – LSASD
Tested Orientation:	Doorset A: Opening towards furnace Doorset B: Opening towards furnace
Sampling information:	No sampling report included
Test Standard:	BS EN 1634-1:2014
Performance:	<p>Integrity: Doorset A: Sustained flaming: 59 minutes Cotton pad test: 59 minutes Gap gauge: 68 minutes Doorset B: Sustained flaming: 68 minutes Cotton pad test: 68 minutes Gap gauge: 68 minutes</p> <p>Insulation I₂: Doorset A: 59 minutes Doorset B: 68 minutes</p>
Reason for Use	<p>For use as primary evidence for</p> <ul style="list-style-type: none"> • Hardware Intumescent • Flush bolts <p>While failures were observed at the leaf perimeter of Doorset A, the test summarised was undertaken to BS EN 1634-1 which as detailed above is more onerous than BS 476-22 it is therefore the opinion of Warringtonfire that these failures do not contradict the scope given herein.</p>
Failure Mode:	<p>Initial Failure: Cotton Pad Failure at top hinge of Doorset A at 59 minutes. Further failure: Continuous flaming across left half of Doorset A leaf head at concealed closer at 59 minutes.</p>

3.1.73 Test Report CFR2006181

Date of Test:	18.JUN.2020
Identification of Test Body:	Cambridge Fire Research Ltd UKAS No. 4319
Sponsor:	Halspan Limited
Tested Product:	Doorset A: Latched, Single Acting, Single Leaf Doorset – LSASD Doorset B: Latched, Single Acting, Single Leaf Doorset – LSASD
Tested Orientation:	Doorset A: Opening towards the furnace Doorset B: Opening away from the furnace
Sampling information:	BM Trada, SC20099, 16 th June 2020
Test Standard:	BS EN 1634-1:2014+A1:2018
Performance:	<p>Integrity: Doorset A: Sustained flaming: 64 minutes Cotton pad test: 68 minutes Gap gauge: 68 minutes Doorset B: Sustained flaming: 54 minutes Cotton pad test: 44 minutes Gap gauge: 68 minutes</p> <p>Insulation I₂: Doorset A: 32 minutes Doorset B: 23 minutes</p>
Reason for Use	<p>For use as primary evidence for</p> <ul style="list-style-type: none"> • Aluminium threshold • Hardware • Environmental seal • Weather bar <p>While failures were observed at the leaf perimeter of Doorset B, the test summarised was undertaken to BS EN 1634-1 which as detailed above is more onerous than BS 476-22 it is therefore the opinion of Warringtonfire that these failures do not contradict the scope given herein.</p>
Failure Mode:	<p>Initial Failure: Cotton Pad Failure at packer midway of left hand frame of Doorset B at 44 minutes Further Failure: Continuous Flaming at packer midway of left hand frame of Doorset B at 54 minutes Further Failure: Continuous Flaming at hanging stile mid-height of Doorset B at 59 minutes</p>

3.1.74 Test Report WF348445/R Issue 2

Date of Test:	13.FEB.2015
Identification of Test Body:	Warringtonfire testing and certification Ltd. UKAS No. 0249
Sponsor:	Simonswerk UK Ltd
Tested Product:	Doorset B: Unlatched, Single Acting, Single Leaf Doorset – ULSASD
Tested Orientation:	Doorset B: Opening towards the furnace
Sampling information:	No sampling report included
Test Standard:	BS EN 1634-1:2014
Performance:	Integrity: Doorset B: Sustained flaming: 64 minutes Cotton pad test: 64 minutes Gap gauge: 66 minutes Insulation I₂: Doorset B: 64 minutes
Reason for Use	For use as primary evidence for <ul style="list-style-type: none">• Concealed hinge

3.1.75 Test Report CFR2109021

Date of Test:	03.SEP.2021
Identification of Test Body:	Cambridge Fire Research Ltd. UKAS No. 4319
Sponsor:	Halspan Limited
Tested Product:	Doorset B: Unlatched, Single Acting, Double Leaf Doorset – ULSADD
Tested Orientation:	Doorset B: Opening towards the furnace
Sampling information:	BM Trada, SC21143, 19 th August 2021
Test Standard:	BS EN 1634-1:2014+A1:2018
Performance:	Integrity: Doorset B: Sustained flaming: 45 minutes Cotton pad test: 64 minutes Gap gauge: 64 minutes Insulation I₂: Doorset B: 45 minutes
Reason for Use	For use as primary evidence for <ul style="list-style-type: none">• Hardware While failures were observed at the leaf perimeter of Doorset B, the test summarised was undertaken to BS EN 1634-1 which as detailed above is more onerous than BS 476-22 it is therefore the opinion of Warringtonfire that these failures do not contradict the scope given herein.
Failure Mode:	Initial Failure: Continuous Flaming at top of meeting stiles of Doorset B at 45 minutes.

3.1.76 Test Report WF504819

Date of Test:	22.JUN.2021
Identification of Test Body:	Warringtonfire Testing and Certification Ltd. UKAS No. 1762
Sponsor:	Halspan Ltd
Tested Product:	Latched, Single Acting, Double Leaf Doorset – LSADD
Tested Orientation:	Opening towards the furnace
Sampling information:	BM Trada, SC21096, 15 th & 16 th June 2021
Test Standard:	BS EN 1634-1:2014+A1:2018
Performance:	Integrity: Sustained flaming: 67 minutes Cotton pad test: 77 minutes Gap gauge: 77 minutes Insulation I₂: 67 minutes
Reason for Use	For use as primary evidence for <ul style="list-style-type: none">• Hardware• Multi point lock• Security viewer

3.1.77 Test Report WF504821

Date of Test:	29.JUN.2021
Identification of Test Body:	Warringtonfire Testing and Certification Ltd. UKAS No. 1762
Sponsor:	Halspan Ltd
Tested Product:	Latched, Single Acting, Double Leaf Doorset – LSADD
Tested Orientation:	Opening away from the furnace
Sampling information:	BM Trada, SC21096, 15 th & 16 th June 2021
Test Standard:	BS EN 1634-1:2014 +A1:2018
Performance:	<p>Integrity: Sustained flaming: 69 minutes Cotton pad test: 58 minutes Gap gauge: 69 minutes Insulation I₂: 58 minutes</p>
Reason for Use	<p>For use as primary evidence for</p> <ul style="list-style-type: none"> • Hardware • Multi point lock <p>While failures were observed at the leaf perimeter of the doorset, the test summarised was undertaken to BS EN 1634-1 which as detailed above is more onerous than BS 476-22 it is therefore the opinion of Warringtonfire that these failures do not contradict the scope given herein.</p>
Failure Mode:	Initial Failure: Cotton Pad Failure at bottom meeting edge at 58 minutes

3.1.78 Test Report WF507671

Date of Test:	09.SEP.2021
Identification of Test Body:	Warringtonfire Testing and Certification Ltd. UKAS No. 1762
Sponsor:	Halspan Ltd
Tested Product:	Latched, Single Acting, Double Leaf Doorset – LSADD
Tested Orientation:	Opening towards the furnace
Sampling information:	BM Trada, SC21148, 02 th September 2021
Test Standard:	BS EN 1634-1:2014+A1:2018
Performance:	Integrity: Sustained flaming: 52 minutes Cotton pad test: 51 minutes Gap gauge: 61 minutes Insulation I₂: 51 minutes
Reason for Use	For use as primary evidence for <ul style="list-style-type: none"> • Hardware • Security viewer While failures were observed at the leaf perimeter of the doorset, the test summarised was undertaken to BS EN 1634-1 which as detailed above is more onerous than BS 476-22 it is therefore the opinion of Warringtonfire that these failures do not contradict the scope given herein.
Failure Mode:	Initial Failure: Cotton Pad Failure at top of meeting corner at 51 minutes Further Failure: Continuous Flaming at top hanging corner of left leaf at 52 minutes Further Failure: Continuous Flaming across head of left leaf at 58 minutes Further Failure: Cotton Pad Test at top hinge of left leaf at 59 minutes Further Failure: Continuous Flaming at top hinge of left leaf at 59 minutes

3.1.79 Test Report WF397957

Date of Test:	23.APR.2018
Identification of Test Body:	Exova Warringtonfire (Now trading as: Warringtonfire Testing and Certification Ltd)
Sponsor:	Codelocks Ltd
Tested Product:	Latched, Single Acting, Single Leaf Doorset – LSASD
Tested Orientation:	Opening towards the furnace
Sampling information:	No sampling report included
Test Standard:	General principals of BS EN 1634-1:2014
Performance:	Integrity: Sustained flaming: 63 minutes Cotton pad test: 63 minutes Gap gauge: 63 minutes Insulation: Insulation I ₂ : Not evaluated
Reason for Use	For use as primary evidence for <ul style="list-style-type: none">• Access control system

3.1.80 Test Report WF327018

Date of Test:	11.MAR.2013
Identification of Test Body:	Exova Ltd. UKAS No. 0246 (Now trading as: Warringtonfire Testing and Certification Ltd)
Sponsor:	Codelocks Ltd
Tested Product:	Doorset B: Latched, Single Acting, Single Leaf Doorset – LSASD
Tested Orientation:	Opening towards the furnace
Sampling information:	No sampling report included
Test Standard:	BS EN 1634-1:2008
Performance:	Integrity: Doorset B: Sustained flaming: 63 minutes Cotton pad test: 63 minutes Gap gauge: 66 minutes Insulation I₂: 63 minutes
Reason for Use	For use as primary evidence for <ul style="list-style-type: none">• Access control system

3.1.81 Test Report Chilt/RF05036

Date of Test:	21.APR.2005
Identification of Test Body:	Chiltern International Fire Ltd. UKAS No. 1762 (Now trading as: Warringtonfire Testing and Certification Ltd)
Sponsor:	Pilkington Glass Ltd
Tested Product:	Unlatched, Single Acting, Single Leaf Doorset – ULSASD
Tested Orientation:	Opening towards the furnace
Sampling information:	No sampling report included
Test Standard:	BS EN 1634-1:2000
Performance:	Integrity: Sustained flaming: 64 minutes Cotton pad test: 67 minutes Gap gauge: 67 minutes Insulation I₂: 20 minutes
Reason for Use	For use as primary evidence for <ul style="list-style-type: none"> • Glazing systems

3.1.82 Test Report WF386186 B

Date of Test:	17.AUG.2017
Identification of Test Body:	Exova Ltd UKAS No. 1762 (Now trading as: Warringtonfire Testing and Certification Ltd)
Sponsor:	Halspan Ltd
Tested Product:	Latched, Single Acting, Single Leaf Doorset – LSASD.
Tested Orientation:	Doorset: Opening towards the furnace
Sampling information:	No sampling report included
Test Standard:	BS 476: Part 20/22: 1987
Performance:	Integrity: 103 minutes Insulation: Insulation: 103 minutes
Reason for Use	For use as primary evidence for <ul style="list-style-type: none"> • Hardware Intumescent • Hardware

3.1.83 Test Report CFR2004171

Date of Test:	17.APR.2020
Identification of Test Body:	Cambridge Fire Research Ltd. UKAS No. 4319
Sponsor:	Halspan Limited
Tested Product:	Doorset B: Latched, Single Acting, Double leaf Doorset – LSADD
Tested Orientation:	Doorset B: Opening towards the furnace
Sampling information:	IFC Certification P197A1, P197A2, P197A, and P197B 2 nd April 2020
Test Standard:	BS EN 1634-1:2014+A1:2018
Performance:	<p>Integrity: Doorset B: Sustained flaming: 53 minutes Cotton pad test: 67 minutes Gap gauge: 67 minutes</p> <p>Insulation I₂: Doorset B: 53 minutes</p>
Reason for Use	<p>For use as primary evidence for</p> <ul style="list-style-type: none"> • Cable loops • Surface mounted face fixed bolts <p>While failures were observed at the leaf perimeter of the doorset, the test summarised was undertaken to BS EN 1634-1 which as detailed above is more onerous than BS 476-22 it is therefore the opinion of Warringtonfire that these failures do not contradict the scope given herein.</p>
Failure Mode:	Initial Failure: Continuous Flaming at threshold from hanging stile to mid-width of Doorset A at 46 minutes. Continuous Flaming at handleset and meeting stile of Doorset B at 53 minutes

3.1.84 Test Report CFR1711171 Revision 1

Date of Test:	17.NOV.2017
Identification of Test Body:	Cambridge Fire Research Ltd. UKAS No. 4319
Sponsor:	Halspan Limited
Tested Product:	Latched, Single Acting, Double Leaf Doorset – LSADD
Tested Orientation:	Opening towards the furnace
Sampling information:	No sampling report included
Test Standard:	BS 476: Part 22: 1987
Performance:	Integrity: 89 minutes Insulation: 89 minutes
Reason for Use	For use as primary evidence for <ul style="list-style-type: none"> • Hardware intumescent • Hardware

3.1.85 Test Report CFR2002051

Date of Test:	05.FEB.2020
Identification of Test Body:	Cambridge Fire Research Ltd. UKAS No. 4319
Sponsor:	Halspan Ltd
Tested Product:	Unlatched, Single Acting, Double Leaf Doorset – ULSADD
Tested Orientation:	Opening towards the furnace
Sampling information:	No sampling report included
Test Standard:	BS 476: Part 22: 1987
Performance:	Integrity: 64 minutes Insulation: 64 minutes In accordance with the note to clause 7.6.1.1 of BS 476: part 22: 1987, the glazing has not been evaluated for insulation
Reason for Use	For use as primary evidence for <ul style="list-style-type: none"> • Hardware • Pull handles • Push plates and kick plates • Glazing systems

3.1.86 Test Report WB112-1B & 2B

Date of Test:	24.JUN.2022
Identification of Test Body:	Thomas Bell-Wright International Consultants Ltd UKAS No. 4439
Sponsor:	Halspan Limited
Tested Product:	Doorset A: Latched, Single Acting, Single Leaf Doorset – LSASD. Doorset B: Latched, Single Acting, Single Leaf Doorset – LSASD.
Tested Orientation:	Doorset A: Opening towards the furnace Doorset B: Opening towards the furnace
Sampling information:	No sampling report included
Test Standard:	EN 1634-1:2014+A1:2018
Performance:	<p>Integrity: Doorset A: Sustained flaming: 54 minutes Cotton pad test: 56 minutes Gap gauge: 56 minutes Doorset B: Sustained flaming: 69 minutes Cotton pad test: 70 minutes Gap gauge: 70 minutes</p> <p>Insulation I₁: Doorset A: 48 minutes Doorset B: 69 minutes</p> <p>Insulation I₂: Doorset A: 54 minutes Doorset B: 69 minutes</p>
Reason for Use	<p>For use as primary evidence for</p> <ul style="list-style-type: none"> • Hardware • Environmental seals • Rebated threshold drop seal • Hardware intumescent • Concealed hinges <p>While failures were observed at the leaf perimeter of the doorsets, the test summarised was undertaken to BS EN 1634-1 which as detailed above is more onerous than BS 476-22 it is therefore the opinion of Warringtonfire that these failures do not contradict the scope given herein.</p>
Failure Mode:	Initial Failure: Continuous Flaming at top right corner of Doorset A at 54 minutes.

3.1.87 Test Report WF404075/A

Date of Test:	20.MAY.2016
Identification of Test Body:	Exova Ltd UKAS No. 0249 (Now trading as: Warringtonfire Testing and Certification Ltd)
Sponsor:	Specialized Security
Tested Product:	Doorset B: Unlatched, Single Acting, Single Leaf Doorset – ULSASD.
Tested Orientation:	Doorset B: Opening towards the furnace
Sampling information:	No sampling report included
Test Standard:	BS EN 1634-1:2014
Performance:	Integrity: Doorset B: Sustained flaming: 63 minutes Cotton pad test: 62 minutes Gap gauge: 68 minutes Insulation I₂: Doorset B: 62 minutes
Reason for Use	For use as primary evidence for <ul style="list-style-type: none"> • Electronic locking

3.1.88 Test Report TB197-1B & 2B

Date of Test:	11.MAR.2020
Identification of Test Body:	Thomas Bell-Wright International Consultants Ltd UKAS No. 4439
Sponsor:	Halspan Limited
Tested Product:	Doorset A: Latched, Single Acting, Single Leaf Doorset – LSASD.
Tested Orientation:	Doorset A: Opening towards the furnace
Sampling information:	No sampling report included
Test Standard:	BS 476: Part 20/22: 1987
Performance:	Integrity: Doorset A: 70 minutes Insulation: Doorset A: 70 minutes
Reason for Use	For use as primary evidence for <ul style="list-style-type: none"> • Hardware

3.1.89 Test Report CFR1808311

Date of Test:	31.AUG.2018
Identification of Test Body:	Cambridge Fire Research Ltd. UKAS No. 4319
Sponsor:	Halspan Ltd
Tested Product:	Doorset A: Latched, Single Acting, Double Leaf Doorset – LSADD.
Tested Orientation:	Doorset A: Opening away from the furnace
Sampling information:	No sampling report included
Test Standard:	BS EN 1634-1:2014
Performance:	Integrity: Doorset A: Sustained flaming: 60 minutes Cotton pad test: 61 minutes Gap gauge: 61 minutes Insulation I₂: Doorset A: 60 minutes
Reason for Use	For use as primary evidence for <ul style="list-style-type: none"> • Hardware intumescent • Surface bolts

3.1.90 Test Report FRR-2008/5506

Date of Test:	26.AUG.2020
Identification of Test Body:	Material Lab Testing Services L.L.C., Dubai ILAC (EIAC – Emirates International Accreditation Centre): 008-LB-TEST
Sponsor:	Halspan Limited
Tested Product:	Latched, Single Acting, Single Leaf Doorset – LSASD.
Tested Orientation:	Opening towards the furnace
Sampling information:	No sampling report included
Test Standard:	BS 476: Part 20/22: 1987/Amd: 2014
Performance:	Integrity: 67 minutes Insulation: 67 minutes
Reason for Use	For use as primary evidence for <ul style="list-style-type: none"> • Hardware intumescent • Hardware

3.1.91 Test Report WF415117

Date of Test:	01.OCT.2019
Identification of Test Body:	Warringtonfire Testing and Certification Ltd. UKAS No. 0249
Sponsor:	Gianni Industries Inc
Tested Product:	Doorset B: Latched, Single Acting, Single Leaf Doorset – LSASD
Tested Orientation:	Doorset B: Opening towards the furnace
Sampling information:	No sampling report included
Test Standard:	BS EN 1634-1:2014+A1:2018
Performance:	<p>Integrity: Doorset B: Sustained flaming: 63 minutes Cotton pad test: 63 minutes Gap gauge: 63 minutes</p> <p>Insulation I₂: Doorset B: 63 minutes</p>
Reason for Use	For use as primary evidence for <ul style="list-style-type: none"> • Cable loops • Hardware • Electronic locking

3.1.92 Test Report CFR1708031

Date of Test:	03.AUG.2017
Identification of Test Body:	Cambridge Fire Research Ltd. UKAS No. 4319
Sponsor:	James Latham
Tested Product:	Unlatched, Single Acting, Single Leaf Doorset – ULSASD.
Tested Orientation:	Opening towards the furnace
Sampling information:	No sampling report included
Test Standard:	BS 476: Part 22: 1987
Performance:	Integrity: 65 minutes Insulation: Insulation: 62 minutes
Reason for Use	For use as primary evidence for <ul style="list-style-type: none"> • Hardware • Glazing systems

3.1.93 Test Report WF434693/LR Issue 2

Date of Test:	14.JAN.2021
Identification of Test Body:	Warringtonfire Testing and Certification Ltd.
Sponsor:	Assa Abloy Ltd
Tested Product:	Doorset A: Latched, Single Acting, Single Leaf, Flush timber Doorset – LSASD
Tested Orientation:	Opening towards the furnace
Sampling information:	None detailed in test report
Test Standard:	Utilising the heating conditions of BS EN 1363-1: 2020
Performance:	Integrity: Doorset A: Sustained flaming: 68 minutes Cotton pad test: 68 minutes Gap gauge: 68 minutes Insulation: Not evaluated.
Reason for Use	For use as primary evidence for <ul style="list-style-type: none"> • Electronic locking

3.1.94 Test Report WF437975/LR

Date of Test:	01.MAR.2021
Identification of Test Body:	Warringtonfire Testing and Certification Ltd. UKAS No. 0249
Sponsor:	Abloy Oy Ltd
Tested Product:	Doorset A: Latched, Single Acting, Single Leaf Doorset – LSASD Doorset B: Latched, Single Acting, Single Leaf Doorset – LSASD
Tested Orientation:	Doorset A: Opening towards the furnace Doorset B: Opening away from the furnace
Sampling information:	Warringtonfire, FM434242, 27 th January 2021
Test Standard:	Utilising the heating conditions of BS EN 1634-1:2014+A1:2018
Performance:	<p>Integrity: Doorset A: Sustained flaming: 66 minutes Cotton pad test: 68 minutes Gap gauge: 68 minutes Doorset B: Sustained flaming: 68 minutes Cotton pad test: 68 minutes Gap gauge: 68 minutes Insulation: Not evaluated</p>
Reason for Use	For use as primary evidence for <ul style="list-style-type: none"> • Access control systems • Hardware

3.1.95 Test Report WF330214 Issue 2

Date of Test:	19.JUN.2013
Identification of Test Body:	Exova Ltd. UKAS No. 0249 (Now trading as: Warringtonfire Testing and Certification Ltd)
Sponsor:	Samuel Heath & Sons PLC
Tested Product:	Unlatched, Single Acting, Single Leaf Doorset – ULSASD
Tested Orientation:	Doorset: Opening towards the furnace
Sampling information:	No sampling report included
Test Standard:	BS EN 1634-1:2008
Performance:	<p>Integrity: Sustained flaming: 46 minutes Cotton pad test: 17 minutes Gap gauge: 62 minutes Insulation I₂: 3 minutes</p>
Reason for Use	<p>For use as primary evidence for</p> <ul style="list-style-type: none"> Jamb mounted concealed closer installation <p>While failures were observed at the glazing location, the test summarised was undertaken to BS EN 1634-1 which as detailed above is more onerous than BS 476-22 it is therefore the opinion of Warringtonfire that these failures do not contradict the scope given herein. Furthermore, the glass is not being used to extend the scope of the doorset design.</p>
Failure Mode:	<p>Initial Failure: Cotton Pad Test over glass panel at 17 minutes Further Failure: Continuous flaming at top right corner of glazed aperture at 46 minutes</p>

3.1.96 Test Report WF401347

Date of Test:	15.AUG.2018
Identification of Test Body:	Exova Ltd. (Now trading as: Warringtonfire Testing and Certification)
Sponsor:	Samuel Heath & Sons
Tested Product:	Doorset B: Unlatched, Single Acting, Single Leaf Doorset – ULSASD
Tested Orientation:	Doorset B: Opening towards the furnace
Sampling information:	No sampling report included
Test Standard:	Utilising the heating conditions of BS EN 1363-1:2012
Performance:	Integrity: Doorset B: Sustained flaming: 67 minutes Cotton pad test: 67 minutes Gap gauge: 67 minutes Insulation: Not evaluated
Reason for Use	For use as primary evidence for <ul style="list-style-type: none">• Jamb mounted concealed closer

3.1.97 Test Report Chilt/RF07141 Revision B

Date of Test:	27.NOV.2007
Identification of Test Body:	Chiltern International Fire UKAS No. 1762 (Now trading as Warringtonfire Testing and Certification Limited)
Sponsor:	Lorient Polyproducts Ltd and Harrison Thompson & Co Ltd
Tested Product:	Doorset A: Unlatched, Single Acting, Double Leaf Doorset – ULSADD. Doorset B: Unlatched, Single Acting, Double Leaf Doorset – ULSADD.
Tested Orientation:	Doorset A: Opening towards the furnace Doorset B: Opening towards the furnace
Sampling information:	No sampling report included
Test Standard:	BS 476: Part 22: 1987
Performance:	Integrity: Doorset A: 62 minutes Doorset B: 67 minutes Insulation: Doorset A: 62 minutes Doorset B: 67 minutes
Reason for Use	For use as primary evidence for <ul style="list-style-type: none">• Hardware intumescent• Hardware

3.1.98 Test Report WF391351

Date of Test:	09.DEC.2017
Identification of Test Body:	Exova Ltd. UKAS No. 0249 (Now trading under: Warringtonfire Testing and Certification)
Sponsor:	Mann McGowan Fabrications Ltd
Tested Product:	Doorset B: Latched, Single Acting, Single Leaf Doorset – LSASD
Tested Orientation:	Doorset B: Opening towards the furnace
Sampling information:	No sampling report included
Test Standard:	BS EN 1634-1:2014
Performance:	Integrity: Doorset B: Sustained flaming: 69 minutes Cotton pad test: 69 minutes Gap gauge: 69 minutes Insulation I₂: Doorset B: 69 minutes
Reason for Use	For use as primary evidence for <ul style="list-style-type: none">• Hardware• Air transfer grille

3.1.99 Test Report TR20220808-005920

Date of Test:	12.SEP.2022
Identification of Test Body:	United Kingdom Testing and Certification UKAS No. 21542
Sponsor:	Halspan Ltd
Tested Product:	Doorset A: Latched, Single Acting, Single Leaf, Flush timber Doorset – LSASD Doorset B: Latched, Single Acting, Single Leaf, Flush timber Doorset – LSASD
Tested Orientation:	Doorset A: Opening towards the furnace Doorset B: Opening away from the furnace
Sampling information:	BM Trada, SC22173, 9 th September 2022
Test Standard:	BS EN 1634-1:2014+A1:2018
Performance:	<p>Integrity: Doorset A: Sustained flaming: 62 minutes Cotton pad test: 62 minutes Gap gauge: 63 minutes Doorset B: Sustained flaming: 66 minutes Cotton pad test: 66 minutes Gap gauge: 67 minutes</p> <p>Insulation I₂: Doorset A: 62 minutes Doorset B: 66 minutes</p>
Reason for Use	For use as primary evidence for <ul style="list-style-type: none"> • Access control systems

3.1.100 Test Report WF520063

Date of Test:	14.OCT.2022
Identification of Test Body:	Warringtonfire Testing and Certification Ltd. UKAS No 1762
Sponsor:	Halspan Limited
Tested Product:	Doorset A: Latched, Single Acting, Single Leaf Doorset – LSASD Doorset B: Latched, Single Acting, Single Leaf Doorset – LSASD
Tested Orientation:	Doorset A: Opening towards the furnace Doorset B: Opening away from the furnace
Sampling information:	BM Trada, SC22145, 26 th & 27 th September, 03 rd October 2022
Test Standard:	BS EN 1634-1: 2014+A1:2018
Performance:	Integrity: Doorset A: 68 minutes Doorset B: 73 minutes Insulation I₂: Doorset A: 45 minutes Doorset B: 50 minutes
Reason for Use	For use as primary evidence for <ul style="list-style-type: none">• Environmental seal• Tracker tags• Glazing systems• Hardware

3.1.101 Test Report CFR2209201

Date of Test:	20.SEP.2022
Identification of Test Body:	Cambridge Fire Research Ltd. UKAS No. 4319
Sponsor:	Halspan Limited
Tested Product:	Latched, Single Acting, Single Leaf Doorset, with side lights and fan lights – LSASD.
Tested Orientation:	Opening towards the furnace
Sampling information:	BM Trada, SC22170, 06 th , 09 th & 12 th September 2022
Test Standard:	BS EN 1634-1:2014+A1: 2018
Performance:	<p>Integrity: Sustained flaming: 56 minutes Cotton pad test: 70 minutes Gap gauge: 70 minutes Insulation I₂: 19 minutes</p>
Reason for Use	<p>For use as primary evidence for</p> <ul style="list-style-type: none"> • Hardwood timber threshold without door stop • Hardware • Concealed overhead closer • Security viewer • Rebated threshold drop seal • Letter plate • Security chain • Feature grooves <p>While failures were observed at the glazing location in a sidelight arrangement, the test summarised was undertaken to BS EN 1634-1 which as detailed above is more onerous than BS 476-22 it is therefore the opinion of Warringtonfire that these failures do not contradict the scope given herein.</p> <p>Furthermore, the glass is not being used to extend the doorset design.</p>
Failure Mode:	Initial Failure: continuous flaming at the surface of the glass within a sidelight arrangement at 56 minutes and 59 minutes. No other failures observed.

3.1.102 Test Report WF523941/MRa

Date of Test:	17.OCT.2022
Identification of Test Body:	Warringtonfire Testing and Certification Ltd. UKAS No. 0249
Sponsor:	Halspan Ltd
Tested Product:	Latched, Single Acting, Double Leaf Doorset – LSADD
Tested Orientation:	Opening towards the furnace
Sampling information:	BM Trada, SC22211, 14 th & 15 th October 2022
Test Standard:	BS EN 1634-1:2014+A1:2018
Performance:	<p>Integrity: Sustained flaming: 63 minutes Cotton pad test: 49 minutes Gap gauge: 68 minutes Insulation I₂: 18 minutes</p>
Reason for Use	<p>For use as primary evidence for</p> <ul style="list-style-type: none"> • Glazing system • Hardware • Pull handles • Push plates & kick plates <p>This report is an evaluation of the potential fire resistance performance if the design were to be tested in accordance with BS 476: Part 22: 1987. If tested to BS 476: Part 22: 1987, a cotton pad test would not normally be applied to the non-insulating elements of a doorset design and therefore the initial failure times are not considered relevant when used for this purpose.</p>
Failure Mode:	Initial Failure: Cotton Pad Test over glass panel at 49 minutes no further failure until in excess of 63 minutes.

3.1.103 Test Report WF526042

Date of Test:	06.DEC.2022
Identification of Test Body:	Warringtonfire Testing and Certification Ltd. UKAS No. 1762
Sponsor:	Halspan Limited
Tested Product:	Latched, Single Acting, Double Leaf Doorset – LSADD
Tested Orientation:	Opening towards the furnace
Sampling information:	BM Trada, SC22247, 30 th November 2022
Test Standard:	BS EN 1634-1:2014 +A1:2018
Performance:	Integrity: 58 minutes Insulation I₂: 58 minutes
Reason for Use	For use as primary evidence for <ul style="list-style-type: none">• Back to back recessed pull handles While failures were observed at the leaf perimeter of the doorset, the test summarised was undertaken to BS EN 1634-1 which as detailed above is more onerous than BS 476-22 it is therefore the opinion of Warringtonfire that these failures do not contradict the scope given herein.
Failure Mode:	Initial Failure: Cotton Pad Failure at the meeting edge at 59 minutes, with a further failure of continuous flaming recorded at 59 minutes.

3.1.104 Test Report BTC 16702F

Date of Test:	08.DEC.2009
Identification of Test Body:	The Building Test Centre UKAS No. 0296
Sponsor:	Rutland UK
Tested Product:	Doorset A: Latched, Single Acting, Single Leaf Doorset – LSASD
Tested Orientation:	Opening towards the furnace
Sampling information:	No sampling report included
Test Standard:	BS EN 1634-1:2008
Performance:	Integrity: Sustained flaming: 75 minutes Cotton pad test: 82 minutes Gap gauge: 77 minutes Insulation I₂: 75 minutes
Reason for Use	For use as primary evidence for <ul style="list-style-type: none"> • Concealed overhead closer

3.1.105 Test Report BMT/FEP/F15273 AR1

Date of Test:	09.DEC.2015
Identification of Test Body:	Exova Ltd UKAS No. 1762 (Now trading as: Warringtonfire Testing and Certification Limited)
Sponsor:	Halspan Ltd
Tested Product:	Unlatched, Single Acting, Double Leaf, Flush timber Doorset – ULSADD.
Tested Orientation:	Opened towards the test conditions
Sampling information:	None detailed in test report
Test Standard:	BS 476: Part 20/22: 1987
Performance:	Integrity: 67 minutes Insulation: 67 minutes
Reason for Use	For use as primary evidence for: <ul style="list-style-type: none"> • Leaf size envelopes • Configurations

3.1.106 Test Report Warres 117483

Date of Test:	27.FEB.2001
Identification of Test Body:	Warrington Fire Research Centre Ltd
Sponsor:	Zero Seal Systems Limited
Tested Product:	Indicative 990mm (h) 990 (w) 54 (t) leaf with two glazed apertures
Tested Orientation:	Test was fixed
Sampling information:	None detailed in test report
Test Standard:	The general principles of BS 476: Part 20: 1987
Performance:	Integrity: 71 minutes Insulation: 71 minutes
Reason for Use	For use as primary evidence for: <ul style="list-style-type: none"> • Zeroplus Slimport SP450 • Zeroplus Slimport SP250 • Circular apertures

3.1.107 Test Report BMT/FEP/F16173 AR1

Date of Test:	2.SEPT.2016
Identification of Test Body:	Exova Ltd UKAS No. 1762 (Now trading as: Warringtonfire Testing and Certification Limited)
Sponsor:	Halspan Ltd
Tested Product:	Doorset A Only: Latched Single Acting, Single Doorset
Tested Orientation:	Doorset A: Opening towards the furnace
Sampling information:	None detailed in test report
Test Standard:	BS 476: Part 20/22: 1987
Performance:	Integrity: 58 minutes Insulation: 58 minutes
Reason for Use	For use as primary evidence for: <ul style="list-style-type: none"> • Drop seals without additional intumescent protection. While failures were observed throughout the duration of this test it has been determined by Warringtonfire that these failures were attributed to the reduced section size of the framing material which was utilised in the doorset assembly.
Failure Mode:	Initial Failure: Continuous flaming at the head of the leaf at 58 minutes. No further failures were observed until in excess of 70 minutes.

4 Technical Specification

4.1 General

The technical specification for the proposed door assemblies is given in the following sections and is based on the test evidence for the door designs, summarised in section 3.

4.2 Intended Use

The intended use of the proposed door assembly is summarised below:

A pedestrian doorset including any frame, door leaf or leaves which is provided to give a fire resisting capability when used for the closing of permanent openings in fire resisting separating elements, which together with the building hardware and any seals (whether provided for the purpose of fire resistance or smoke control or for other purposes such as draught or acoustics) form the assembly.

4.3 Door Leaf

The Prima 60 door design (herein referred to as Leaf 1) can include various design features.

The door designs considered in this Part 1 of the suite of FEA/F96103 field of applications for the Prima 60 product family can include:

1. Glazing
2. Feature Grooves including insert materials
3. Decorative facings
4. PVC & ABS Lippings
5. Decorative planted on timber mouldings
6. Various hardware options

Specific sections within this assessment must be referred to for design limitations and construction requirements.

Section 5 gives the description of leaf type in terms of composition and density etc.

4.4 Door Frames

Doorsets constructed using different frame options can include various design features as summarised below.

Specific sections within this assessment must be referred to for design limitations and construction requirements, where applicable.

Specific installation details relating to frame types can be found within section 11.2 which must be complied with.

Note: Gaps in frame reference numbering are intentional.

4.4.1 Frame 1: Hardwood Timber

The construction of the Frame 1 door frame is hardwood (not Beech, *fagus species*) with minimum frame dimensions fitted flush to wall or within the wall thickness.

Frame 1 may also be installed as detailed in section 11.2.4 to form a shadow gap.

For further information on the specification and construction of the door frames see section 7.

4.4.2 Frame 2: Beech Timber

The construction of the Frame 2 door frame is Beech (*fagus species*) with minimum frame dimensions fitted flush to wall or within the wall thickness, unless permitted elsewhere in this assessment.

For further information on the specification and construction of the door frames see section 7.

4.4.3 Frame 3: MDF

The construction of the Frame 3 door frame uses solid lengths of MDF with minimum frame dimensions fitted flush to wall or within the wall thickness.

Frame 3 may also be installed as detailed in section 11.2.4 to form a shadow gap.

For further information on the specification and construction of the door frames see section 7.

4.4.4 Frame 4: 2 part MDF or Hardwood with integral architrave

The construction of the Frame 4 door frame is based on the design tested in CFR2211141 (Left Hand doorset), and covers the following types:

- (1) 2 part MDF with minimum frame dimensions and the frame sections installed such that it projects in front of the line of the wall and returns across the face of the wall.
- (2) 2 part Hardwood (not beech, *Fagus species*) with minimum frame dimensions and the frame sections installed such that it projects in front of the line of the wall and returns across the face of the wall.

For further information on the specification and construction of the door frames see section 7.

4.4.5 Frame 5: Projecting Hardwood or MDF

The construction of the Frame 5 door frames is based on MDF or hardwood with minimum frame dimensions. The design is a rectangular frame cross section fitted with the opening face of the frame projecting beyond the wall, and is a variation of the design tested in CFR2211141 (Left Hand doorset).

For further information on the specification and construction of the door frames see section 7.

4.4.6 Frame 7: WoodEx Frame

The construction of these bespoke door frames is based on engineered hardwood timber with minimum frame dimensions fitted flush to wall or within the wall thickness.

For further information on the specification and construction of the door frames see section 7.

The WoodEx frame (Frame 7) has been tested in 3 different types of engineered timber, as reported in test evidence BMT/FEP/F14102, BMT/FEP/F16037 and WF420277. An analysis of the WoodEx test evidence has been carried out.

Test reference WF420277, which included Prima 60 tested as an ULSASD configuration with 2no 15x4mm perimeter intumescent strips at the WoodEx head and jambs, has been compared against other tests using a similar size leaf of Prima 60 in an ULSASD configuration with the same size perimeter intumescent strips, namely RF0006A (2100mm x 900mm, 60 minutes) RF06005A (2125mm x 915mm, 75 minutes) and RF06005B (2125mm x 915mm, 75 minutes). WF420277 has been deemed acceptable to support the use of locks fitted to single leaf doorsets, as the initial failure was remote from the frame and the subsequent failure was at a hinge position at 65 minutes. The subsequent failure time of WF420277 is within the range of failures seen for the other ULSASD Prima 60 tests considered. This test is used to support the use of single leaf doorsets with the WoodEx products detailed in section 7.

Consideration of the test data based on the WoodEx frames and Frame 1, provides evidence of a comparative performance of the WoodEx frame designs against Frame 1 which is based on solid timber. The use of the WoodEx products as detailed in section 7 are permitted.

The leaf size envelopes for Frame 1 can be used for Frame 7, subject to the limitations associated with configurations and intumescent for this frame, which are given in section 4.5.6.

4.5 Doorset Configurations & Maximum Leaf Sizes

4.5.1 General

The evaluation of the leaf size for each frame option and doorset configuration is based on the tests listed in Section 3 and takes into account:

1. The margin of over performance above 60 minutes integrity for the design
2. The characteristics exhibited during test and
3. The doorset configuration tested.

The evaluation of the permitted configurations included in this field of application is based on the configurations tested. The principle is that the more components included in testing, for example, double door leaves and an overpanel – the harder it becomes to pass a test. In this specific example it is because the junction between two door leaves or door leaf and overpanel introduces a discontinuity into the doorset which can be a means of failure. This approach leads to the following statements:

1. A test on a double doorset is more onerous than a test on a single doorset.
2. A test on a doorset with a flush overpanel is more onerous than a test on a doorset without an overpanel. A flush overpanel has the same thickness as the door leaf and is flush with the leaf/leaves.
3. A test on an unlatched doorset is more onerous than a test on a latched doorset as the leading edge is unrestrained and will deflect more in fire test conditions.
4. A test on an unlatched single acting doorset is considered to be equivalent to a double acting doorset, due to the known deflection of an unlatched single acting doorset towards the furnace conditions i.e. away from the door stop. However, this does not cover doorsets with flush overpanels.
5. A doorset with transomed overpanel is considered to perform comparably to a similar doorset without an overpanel. This is because the transom structurally separates the overpanel from the doorset.





The leaf size for each door leaf option and configuration is linked to the perimeter intumescent specification and frame option. The following section details the maximum leaf size for each door leaf option and configuration based on the intumescent specification and frame details tested.

Doorsets with reduced height and width dimensions from those tested are deemed to be less onerous. Therefore, doors with dimensions less than those given in the leaf size envelopes (for the relevant intumescent specification) in the following sections are covered and may be manufactured.

4.5.2 Configuration

The table below shows the permitted configurations for the Prima 60 doorset design, with the abbreviation and full description of each configuration.

The following sections details the assessed maximum leaf size envelopes for each permitted configuration based on the intumescent specification and door frame tested.

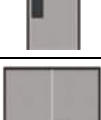
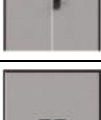
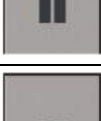
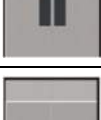
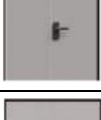
Doorset Configurations		
Depiction	Abbreviation	Description
	LSASD	Latched Single Acting Single Doorset
	ULSASD	Unlatched Single Acting Single Doorset
	DASD	Double Acting Single Doorset
	LSASD+OP	Latched Single Acting Single Doorset + Flush Overpanel
	ULSASD+OP	Unlatched Single Acting Single Doorset + Flush Overpanel
	LSADD	Latched Single Acting Double Doorset
	ULSADD	Unlatched Single Acting Double Doorset
	DADD	Double Acting Double Doorset
	LSADD+OP	Latched Single Acting Double Doorset + Flush Overpanel
	ULSADD+OP	Unlatched Single Acting Double Doorset + Flush Overpanel

4.5.3 Orientation

The majority of primary fire resistance tests for these designs were conducted with the doorset hung such that the door leaf opened towards the fire, which is considered the most onerous orientation in terms of fire resistance performance. Based on this testing, assessment is made that the doorsets to this design may be hung either away from or towards the fire risk side of the doorset. The rationale behind the direction of fire testing timber based doorsets opening towards the fire test conditions is further explained in Annex C of BS EN 1634-1:2014 +A1:2018.

For example, test reference WF508668 was undertaken with the same design of doorset tested both opening in towards the furnace heating conditions and out away from the heating conditions. The doorset opening in achieved 62 minutes integrity and the doorset opening out achieved 74 minutes integrity performance, therefore validating the point made above.

The report may refer to the opening or closing face of the door, for clarity the following drawing defines which face is the opening face.

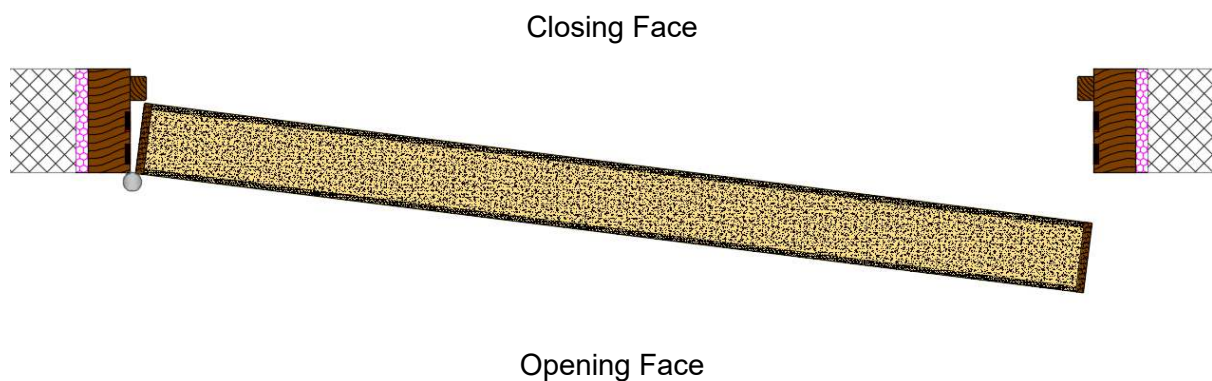

4.5.4 Envelopes for each Configurations

The following sections detail the door leaf envelopes which indicate the permitted leaf sizes for the listed configurations based on the perimeter intumescent, door leaf option and door frame.

Unequal leaf double doorsets are covered by this assessment with no restriction on the smaller leaf dimensions providing it does not exceed the relevant leaf size envelope and is not smaller in width than 300mm.

For equal double doorsets both leaves must comply with the door leaf envelope size limitations.

A table of essential hardware is given in section 10.3 for each doorset configuration, as a minimum requirement for the doorset described. Changes to hardware can affect the intumescent specification and frame details which are subsequently considered for each specific hardware component, where required.

4.5.4.1 General Note on Intumescent Seals

- Intumescent seals are to be fitted centrally unless stated otherwise.
- Intumescent seals are may be interrupted at hardware locations unless stated otherwise, in all cases any interruption shall be kept to a minimum.
- Intumescent seals must run the full length of the leaf edge or frame reveals, with tightly formed abutting corner joints, unless stated otherwise.
- Vertical perimeter intumescent seals may include one tight butt joint in their length if needed.
 - Where two seals are fitted, the joints must be offset by a minimum of 100mm and may not be coincident.
 - Where one seal is fitted the joint must be in the lower half of the doorset.
- Intumescent seals are not to be concealed below lippings.
- While intumescent seals are not specified to be applied at the bottom edge of the leaf, their application may be a requirement for certain elements of building hardware. It is the opinion of Warringtonfire that the application of intumescent seals across the bottom edge of the leaf will not detract from the fire resistance performance under test conditions, when applied the intumescent may consist of either:
 - 1No. Intumescent seal no greater than 30mm wide, centrally fitted or
 - 2No. Intumescent seals, each no greater than 15mm wide.
- Inclusion of specific design details for example hardware may require a different intumescent seal specification compared to that stated for the leaf configurations in sections 4.5.7 to 4.5.16. Where this is the case, it is important that the following conditions are met:
 - The intumescent type given for the specific design detail must match that given for the required leaf configuration and leaf size (e.g. if Halspan SLS is given as the required seal type, only leaf configurations and sizes approved for Halspan SLS seals can be used).
 - The largest of the intumescent specifications given for the different design details must take precedence, which is to be determined by the total amount of intumescent required for that doorset design (e.g. if the total amount of perimeter intumescent for a particular hardware item is greater than that required for the associated leaf configuration and size, the intumescent detail stated for the item of hardware would take

precedence and an alternative perimeter intumescent must be used to ensure both requirements are met).

4.5.4.2 Explanation for following sections

The performance of a doorset in terms of configuration and size is dependent on the leaf type, perimeter intumescent used and frame type. These elements are not automatically interchangeable. The following sections present the envelopes for the Prima 60 Leaf 1 and 6 frame types. Each envelope is linked to a specific perimeter intumescent which is given a unique reference and is based directly on test evidence.

The envelopes are presented as follows:-

- for LSASD increasing in configuration complexity up to ULSADD+OP
- for each configuration, each frame type is considered separately,
- for each configuration, frame type and intumescent specification is considered separately and a unique envelope of permitted leaf sizes is presented based on the configuration, leaf type, frame type and intumescent and the envelope is directly linked to a unique test.

4.5.4.3 Summary of Permitted Configuration for Prima 60 (Leaf 1) & Frame Option

Permitted Configurations with frame types 1, 2, 3, 4, 5 and 7 with leaf type 1 (Prima 60)											
Frame		Configuration									
		LSASD	ULSASD	DASD	LSASD OP	ULSASD OP	LSADD	ULSADD	DADD	LSADD OP	ULSADD OP
1	Hardwood frame*	Yes	Yes	Yes	Yes	Yes	Yes	Yes	Yes	Yes	Yes
2	Beech frame*	Yes	Yes	Yes	No	No	Yes	Yes	Yes	No	No
3	MDF frame*	Yes	Yes	Yes	No	No	Yes	Yes	Yes	No	No
4	MDF or Hardwood part frame *	Yes	Yes	No	No	No	Yes	Yes	No	No	No
5	Projecting Hardwood or MDF	Yes	Yes	No	No	No	Yes	Yes	No	No	No
7	WoodEx frame*	Yes	Yes	No	No	No	Yes	Yes	No	No	No

* See Section 7 for specific limitations with respect to the framing types

4.5.5 Specific Leaf Size Limitations

It is important to note that there are specific leaf size limitations relating to some design features of the Prima 60 doorset design. When considering the following design features it is the smallest of the permitted leaf sizes related to the doorset design that applies.

- Perimeter Intumescent, Frame type and Configuration (Section 4.5)
- Door leaf design features (Section 5)
- Hardware (Section 10)

4.5.5.1 Leaf Sizes Frame 1

The leaf sizes, configurations and intumescent specification permitted for Leaf 1 + Frame 2 may be additionally utilised with Leaf 1 + Frame 1.

This is on the basis that, the hardwood timber specified for Frame 1 has been proven to be more robust under test conditions than the Frame 2 specification.

4.5.6 Frame 7: Leaf Size, Configurations & Intumescent Specifications

The test evidence has demonstrated that the WoodEx frame can be considered similar in performance to Frame 1 for LSASD, ULSASD, LSADD and ULSADD configurations, when used with a minimum of 2No. 15mm wide x 4mm thick perimeter intumescent seals.

The specific intumescent specifications which are permitted for use with Frame 7 are detailed in the relevant subsection of sections 4.5.7, 4.5.8, 4.5.12 or 4.5.13.

See section 7.6 for constructional details of Frame 7.

4.5.7 LSASD Configuration: Leaf Sizes & Intumescent Specification

4.5.7.1 Leaf 1 + Frame 1 Doorset

Leaf size envelopes for LSASD using Leaf 1 and Frame 1 with Halspan seals (1 of 2)

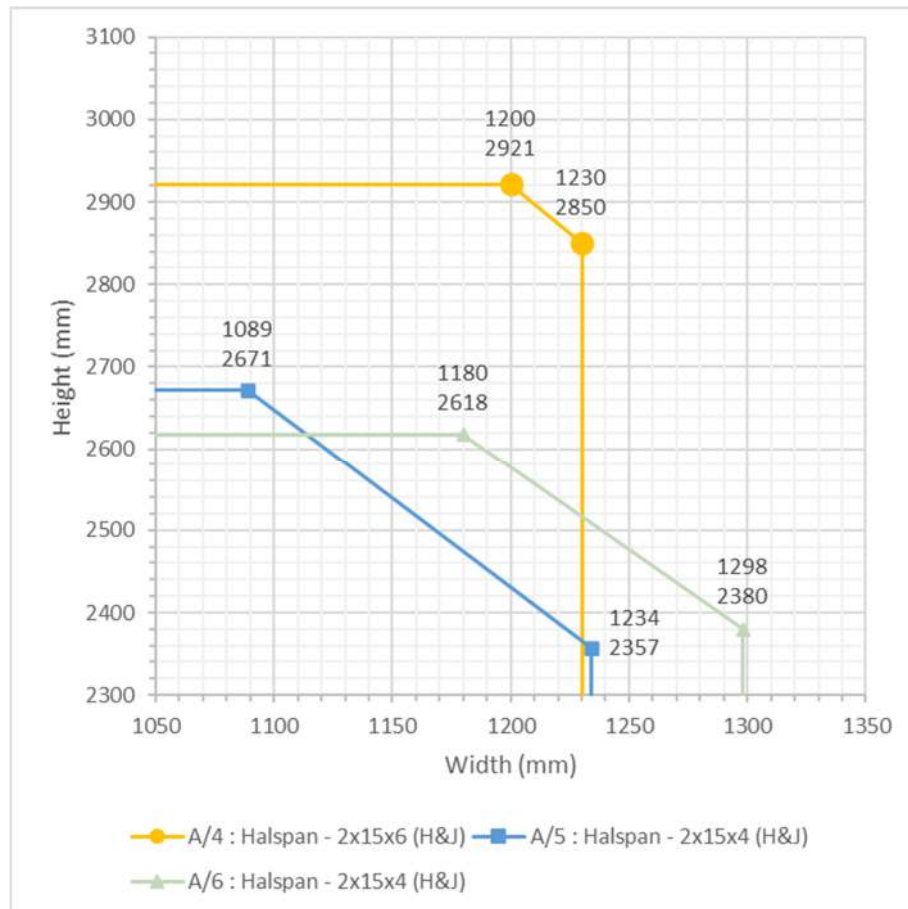

Leaf size envelopes for LSASD using Leaf 1 and Frame 1 with Halspan seals (2 of 2)

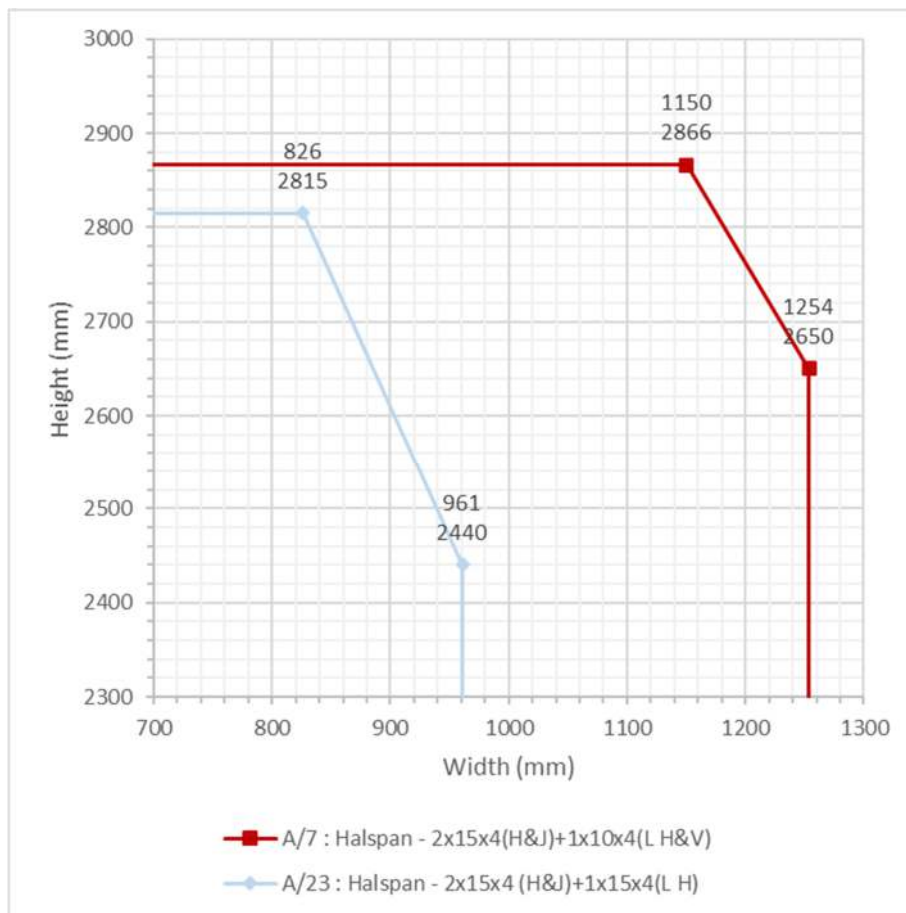

Halspan Intumescent Specification for LSASD Leaf 1 with Frame 1		
Intumescent Spec. Reference (Test Reference)	Make / Type	Location & Size
A/4 (WF384748B)	Halspan BOM- T60- 100	Head & Jambs: 2no 15x6. (each comprising 15x2 graphite under 15x4 PVC encapsulated graphite). Fitted in frame reveal, centrally and 10mm apart
A/5 (WF380349B)	Halspan SLS	Head & Jambs: 2no 15x4. Fitted in frame reveal, centrally and 10mm apart
A/6 (WF375153B)	Halspan SLS	Head & Jambs: 2no 15x4. Fitted in frame reveal, centrally and 10mm apart
A/7 (CFR1802131)	Halspan SLS	Head & Jambs: 2no 15x4. Fitted in frame reveal, centrally and 10mm apart Leaf head and vertical edges: 1no 10x4. Fitted centrally in leaf edges
A/23 (CFR2211141 RH)	Halspan SLS	Head & Jambs: 2no 15x4. Fitted in frame reveal and 10mm apart Leaf head: 1no 15x4. Fitted centrally in leaf edge

Leaf size envelopes for LSASD using Leaf 1 and Frame 1 with Lorient seals

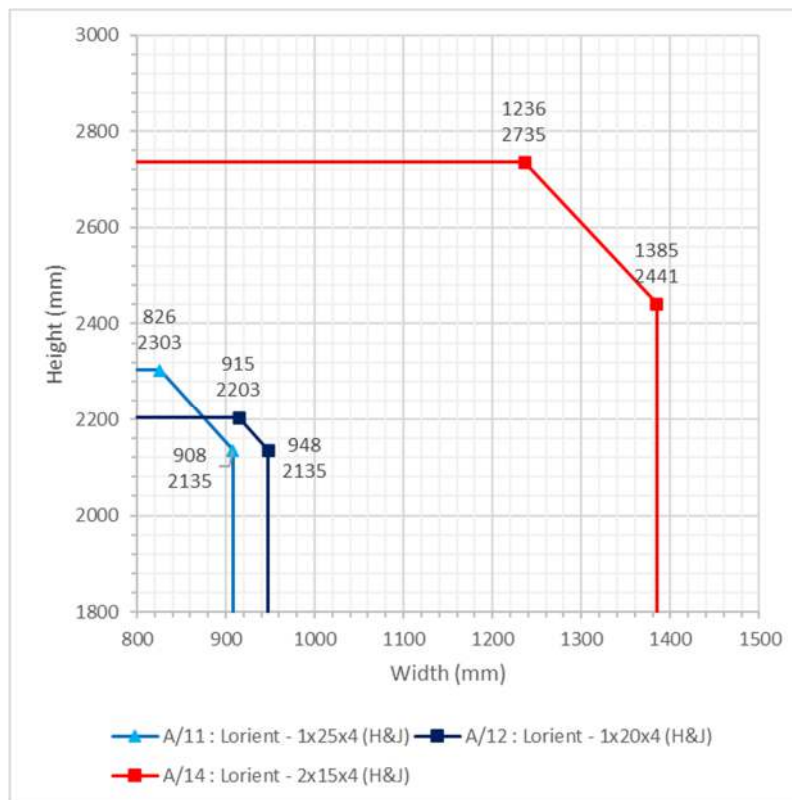

Lorient Intumescent Specification for LSASD Leaf 1 with Frame 1		
Intumescent Spec. Reference (Test Reference)	Make / Type	Location & Size
A/11 (RF03041A)	LP2504 Type 617 ¹	Head & Jambs: 1no 25x4. Fitted in frame reveal
A/12 (RF03041B)	LP2004 Type 617 ¹	Head & Jambs: 1no 20x4. Fitted in frame reveal
A/14 (RF07128A)	LP1504 Type 617	Head & Jambs: 2no 15x4. Fitted in frame reveal and 10 mm apart

For leaf size envelopes for LSASD using Leaf 1 and Frame 1 using Lorient seals see intumescent specification A/27 within section 4.5.7.2 which is permitted in addition to those detailed above.

Note

1. Test references RF03041A and RF03041B were carried out using Lorient Palusol intumescent seals. Comparisons have been made between the performance of test references RF0006A and RF06005A with integrity performances of 60 and 75 minutes respectively (both ULSASD using 2no 15x4mm Palusol intumescent seals fitted in the frame reveals) against test reference RF07128A with integrity performance of 72 minutes (ULSASD using 2no 15x4mm Lorient 617 type intumescent seals fitted in the frame reveals). There were differences in the tested leaf size, with RF07128A being a larger tested leaf, which would be considered to be a more onerous test. It is therefore the opinion of Warringtonfire that for the designs considered herein, when the tested intumescent was Lorient Palusol that Lorient Type 617 can be used at the same intumescent sizes. The above table states the permitted intumescent type.

Leaf size envelopes for LSASD using Leaf 1 and frame 1 with ISL or Mann McGowan seals

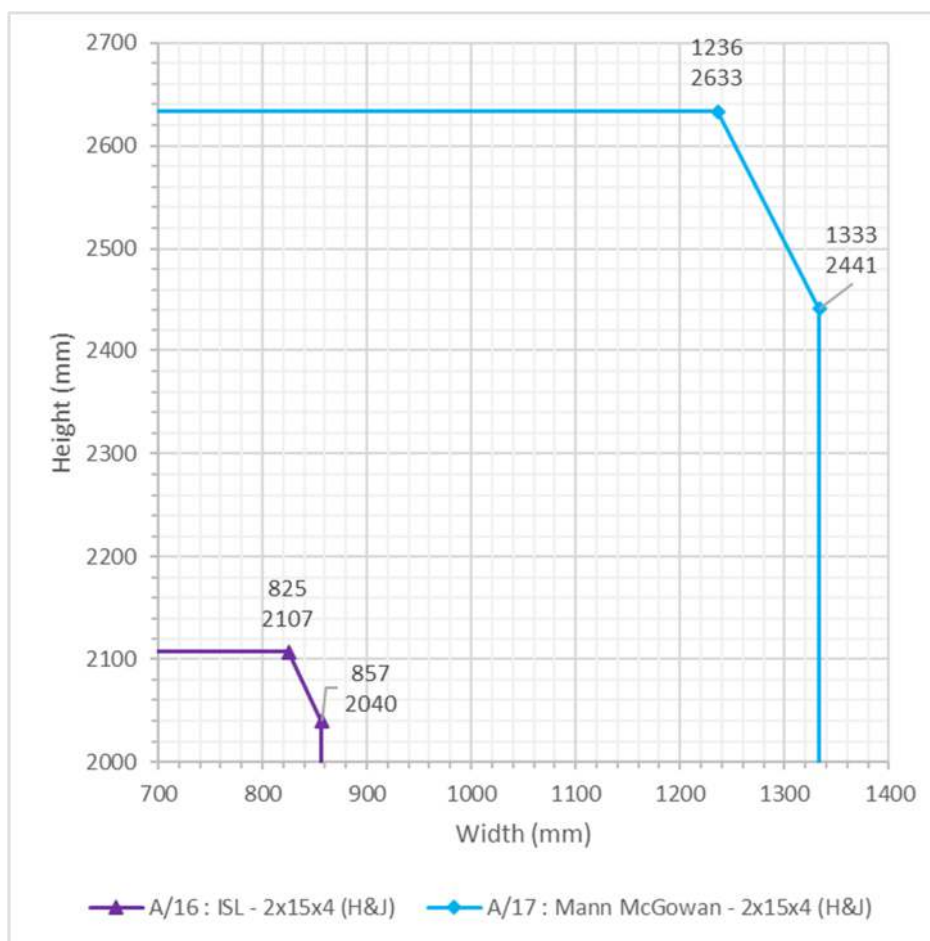

ISL or Mann McGowan Intumescent Specification for LSASD Leaf 1 with Frame 1		
Intumescent Spec. Reference (Test Reference)	Make / Type	Location & Size
A/16 (RF01056B)	ISL Therm-A-Seal	Head & Jambs: 2no 15x4. Fitted in frame reveal and 10mm apart
A/17 (RF07128B)	Mann McGowan Pyrostrip100	Head & Jambs: 2no 15x4. Fitted in frame reveal and 10mm apart

Leaf size envelopes for LSASD using Leaf 1 and Frame 1 with Pyroplex seals

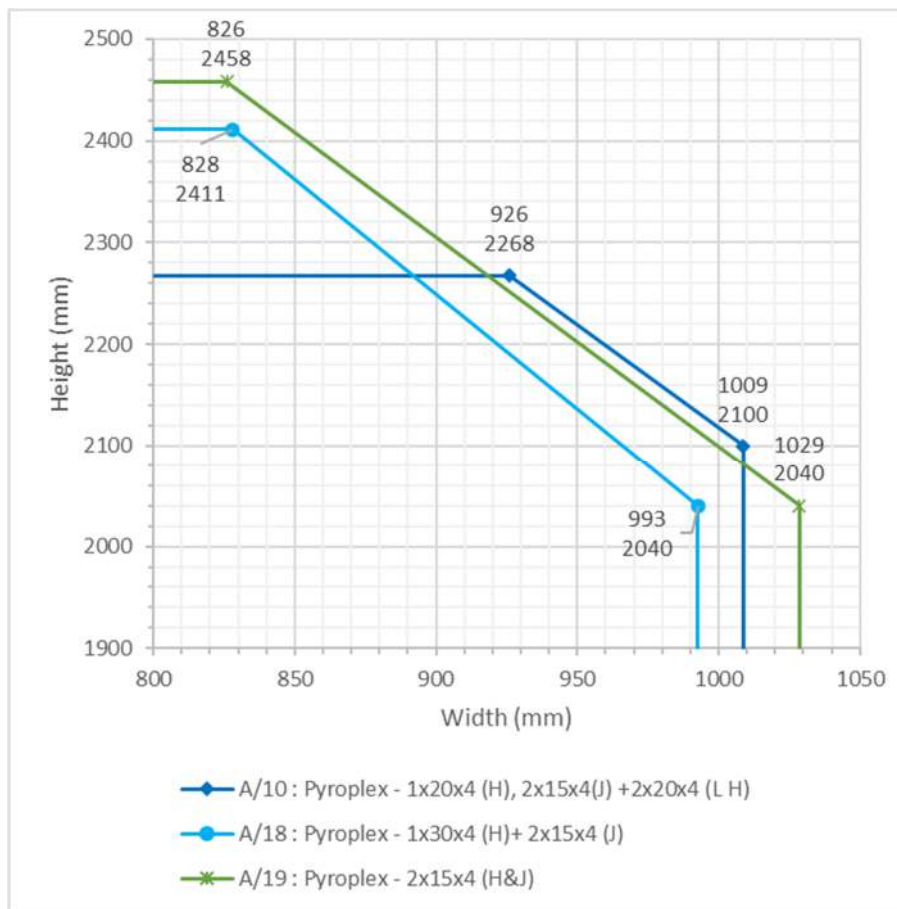

Pyroplex Intumescent Specification for LSASD Leaf 1 with Frame 1		
Intumescent Spec. Reference (Test Reference)	Make / Type	Location & Size
A/10 (WF504390)	Pyroplex 8600 8700 / 30155 30156	Head: 1no 20x4. Fitted in frame reveal Jambs: 2no 15x4. Fitted in frame reveal and 10mm apart Leaf Head: 2no 20x4. Fitted in leaf head and 8mm apart
A/18 (RF02018 Rev A)	Pyroplex 3009412 8721	Head: 1no 30x4. Fitted in frame head reveal Jambs: 2no 15x4. Fitted in frame jamb reveal centrally and 10mm apart
A/19 (CFR2103161)	Pyroplex 8700 / 30155	Head & Jambs: 2no 15x4. Fitted in frame reveal and 10mm apart

Leaf size envelopes for LSASD using Leaf 1 and Frame 1 with STS seals.

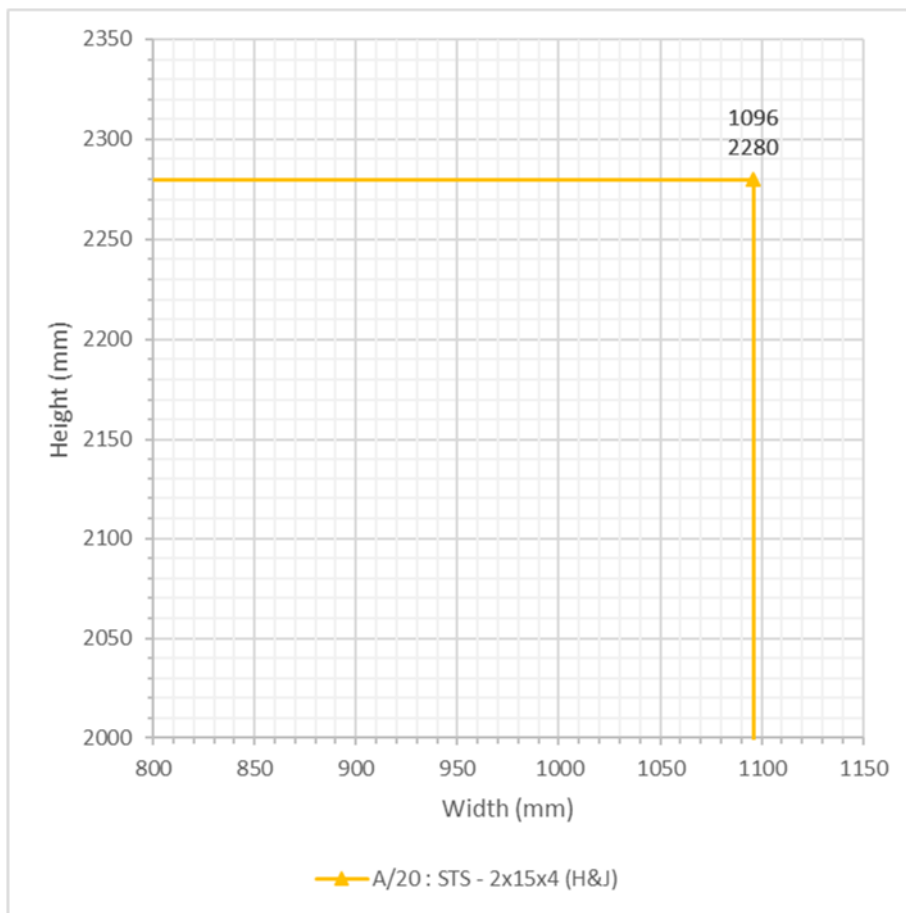

STS Intumescent Specification for LSASD Leaf 1 with Frame 1		
Intumescent Spec. Reference (Test Reference)	Make / Type	Location & Size
A/20 (BMT/FEP/F15163)	STS ST1504FO	Head & Jamb: 2no 15x4. Fitted in frame reveal and 10mm apart

4.5.7.2 Leaf 1 + Frame 2 Doorset

Leaf size envelopes for LSASD using Leaf 1 and Frame 2 using Halspan and Firestop seals.

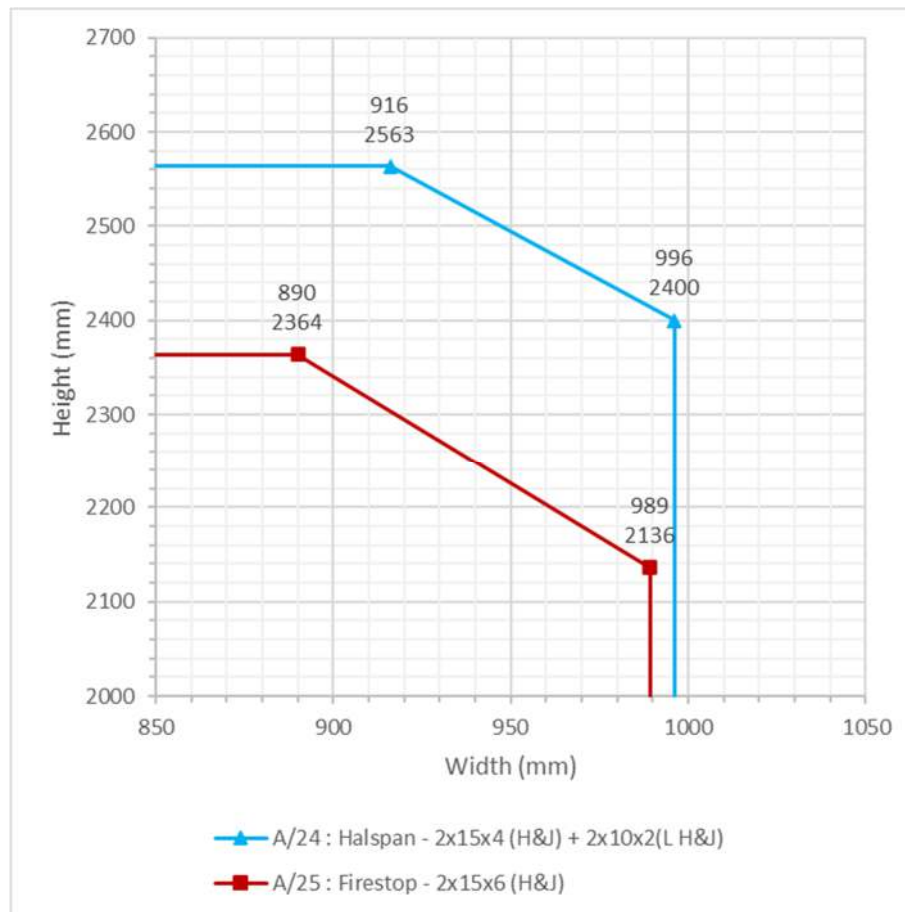

Halspan and Firestop Intumescent Specification for LSASD Leaf 1 with Frame 2		
Intumescent Spec. Reference (Test Reference)	Make / Type	Location & Size
A/24 (CFR1809241)	Halspan SLS Halspan MAP	Head & Jambs: 2no 15x4. Fitted in frame reveal, centrally and 10mm apart Leaf head and vertical edges: 2no layers 10x2. Fitted in a 10x4 rebate centrally in leaf edges
A/25 (FRR-2010/2942)	Firestop FS438	Head & Jambs: 2no 15x6. Fitted in frame reveal, centrally and 8mm apart

Leaf size envelopes for LSASD using Leaf 1 and Frame 2 using Lorient seals.

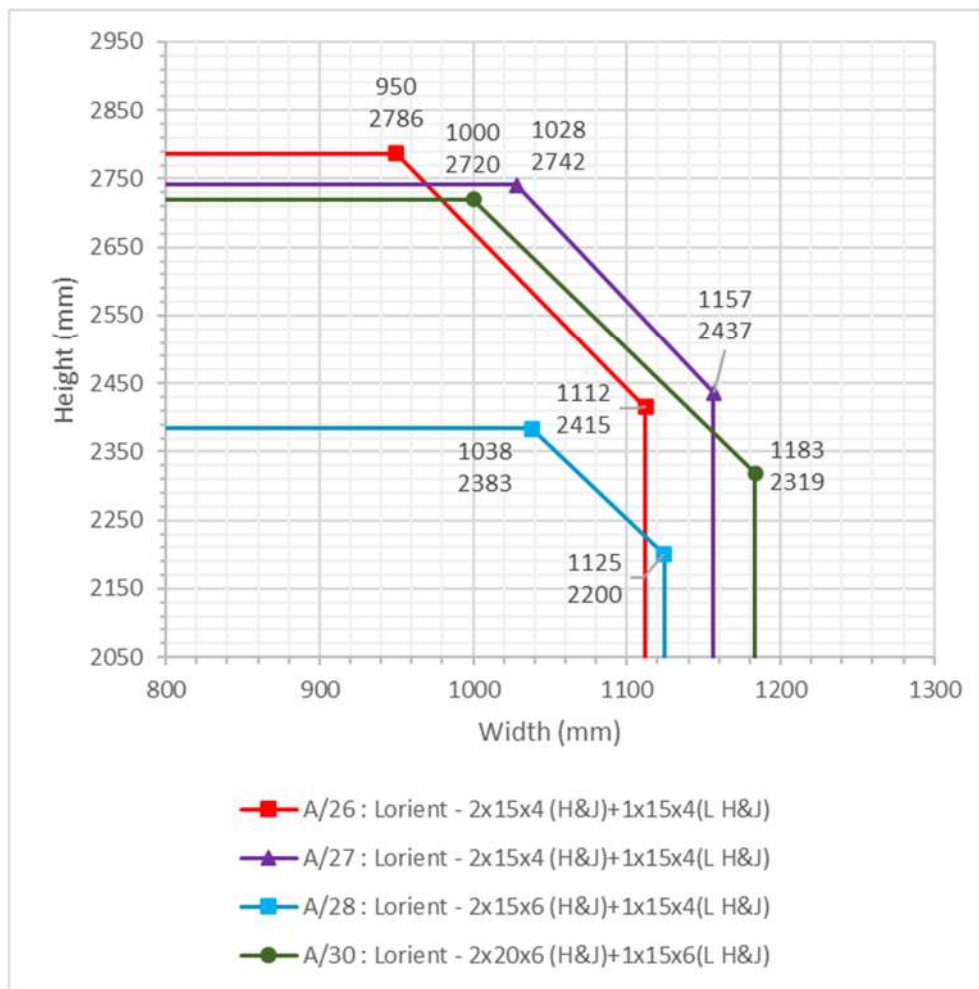

Lorient Intumescent Specification for LSASD Leaf 1 with Frame 2		
Intumescent Spec. Reference (Test Reference)	Make / Type	Location & Size
A/26 (FRR-2009/2351)	Lorient LP1504	Head & Jambs: 2no 15x4. Fitted in frame reveal, centrally and 10mm apart Leaf head and vertical edges: 1no 15x4. Fitted centrally in leaf edges
A/27 (FRR-2009/1221 (SP1))	Lorient LP1504	Head & Jambs: 2no 15x4. Fitted in frame reveal, centrally and 10mm apart Leaf head and vertical edges: 1no 15x4. Fitted centrally in leaf edges

Lorient Intumescent Specification for LSASD Leaf 1 with Frame 2		
Intumescent Spec. Reference (Test Reference)	Make / Type	Location & Size
A/28 (FRR-2110/1497)	Lorient LP1506	Head & Jambs: 2no 15x6. Fitted in frame reveal, centrally and 15mm apart
	Lorient LP1504	Leaf head and vertical edges: 1no 15x4. Fitted centrally in leaf edges
A/30 (FRR-2102/4628A)	Lorient LP2006	Head: 2no 20x6. Fitted in frame head reveal, centrally and 15mm apart
	Lorient LP1506	Jambs: 2no 20x6. Fitted in frame jamb reveal, centrally and 6mm apart Leaf head and vertical edges: 1no 15x6. Fitted centrally in leaf edges

4.5.7.3 Leaf 1 + Frame 3 Doorset

Leaf size envelopes for LSASD using Leaf 1 and Frame 3 using Halspan seals.

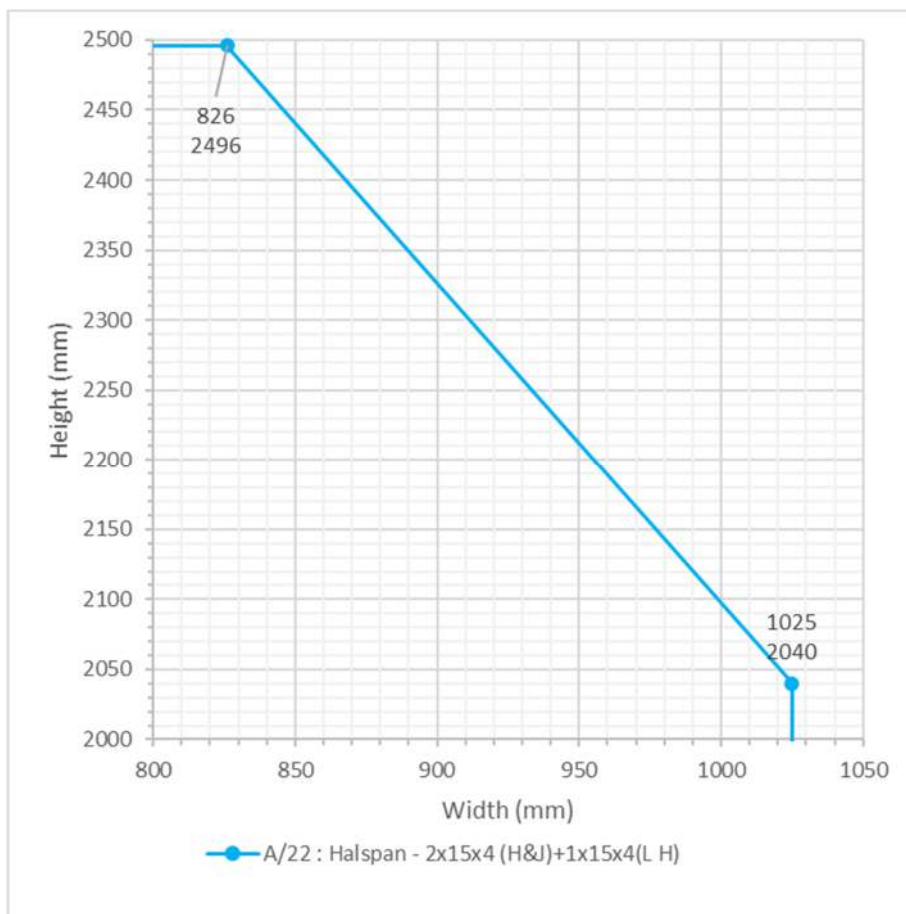

Halspan Intumescent Specification for LSASD Leaf 1 with Frame 3		
Intumescent Spec. Reference (Test Reference)	Make / Type	Location & Size
A/22 (CFR2211141 LH)	Halspan SLS	Head & Jamb: 2no 15x4. Fitted in frame reveal, centrally and 10mm apart Leaf head: 1no 15x4. Fitted centrally in leaf edge

Leaf size envelopes for LSASD using Leaf 1 and Frame 3 using Lorient seals.

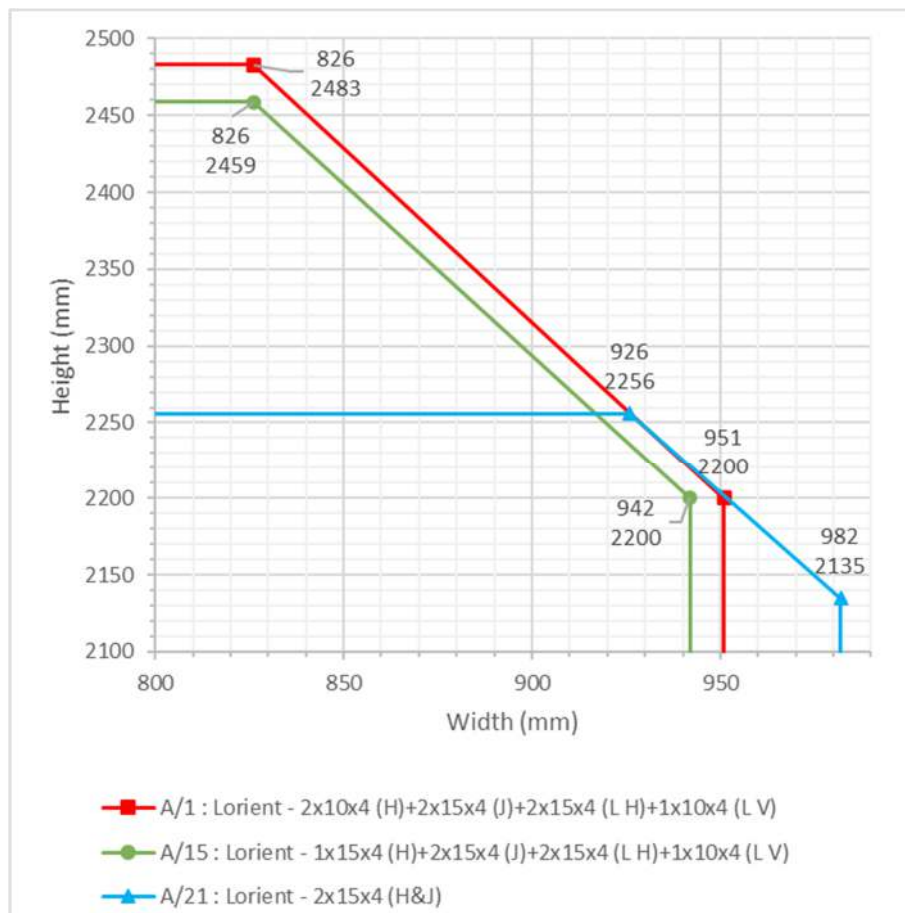

Lorient Intumescent Specification for LSASD Leaf 1 with Frame 3		
Intumescent Spec. Reference (Test Reference)	Make / Type	Location & Size
A/1 (WF509420)	Lorient LP1004	Head: 2no 10x4. Fitted in frame head reveal, centrally and 25mm apart
	Lorient LP1504	Jamb: 2no 15x4. Fitted in frame jamb reveal, centrally and 10mm apart
	Lorient LP1504	Leaf heads: 2no 15x4. Fitted in leaf heads, centrally and 10mm apart
	Lorient LP1004	Leaf hanging edges: 1no 10x4. Fitted centrally in leaf edges

Lorient Intumescent Specification for LSASD Leaf 1 with Frame 3		
Intumescent Spec. Reference (Test Reference)	Make / Type	Location & Size
A/15 (WF509421)	Lorient LP1504	Head: 1no 15x4. Fitted in frame head reveal, centrally
	LP1504	Jamb: 2no 15x4. Fitted in frame jamb reveal, centrally and 10mm apart
	LP1504	Leaf heads: 2no 15x4. Fitted in leaf heads, centrally and 10mm apart
	LP1004	Leaf hanging edges: 1no 10x4. Fitted centrally in leaf edges
A/21 (F15012B)	Lorient LP1504	Head & Jamb: 2no 15x4. Fitted in frame reveal, centrally and 10mm apart

4.5.7.4 Leaf 1 + Frame 4 or 5 Doorset

For leaf size envelopes for LSASD using Leaf 1 and Frame 4 or 5 using Halspan seals see intumescent specification A/22 within section 4.5.7.3.

4.5.7.5 Leaf 1 + Frame 7 Doorset

For leaf size envelopes for LSASD using Leaf 1 and Frame 7 see intumescent specifications A/4, A/5, A/6, A/7, A/10, A/14, A/16, A/17, A/19, A/20 & A/23 within section 4.5.7.1.

4.5.8 ULSASD Configuration: Leaf Sizes & Intumescent Specification.

4.5.8.1 Leaf 1 + Frame 1 Doorset

Leaf size envelopes for ULSASD using Leaf 1 and Frame 1 with Halspan seals

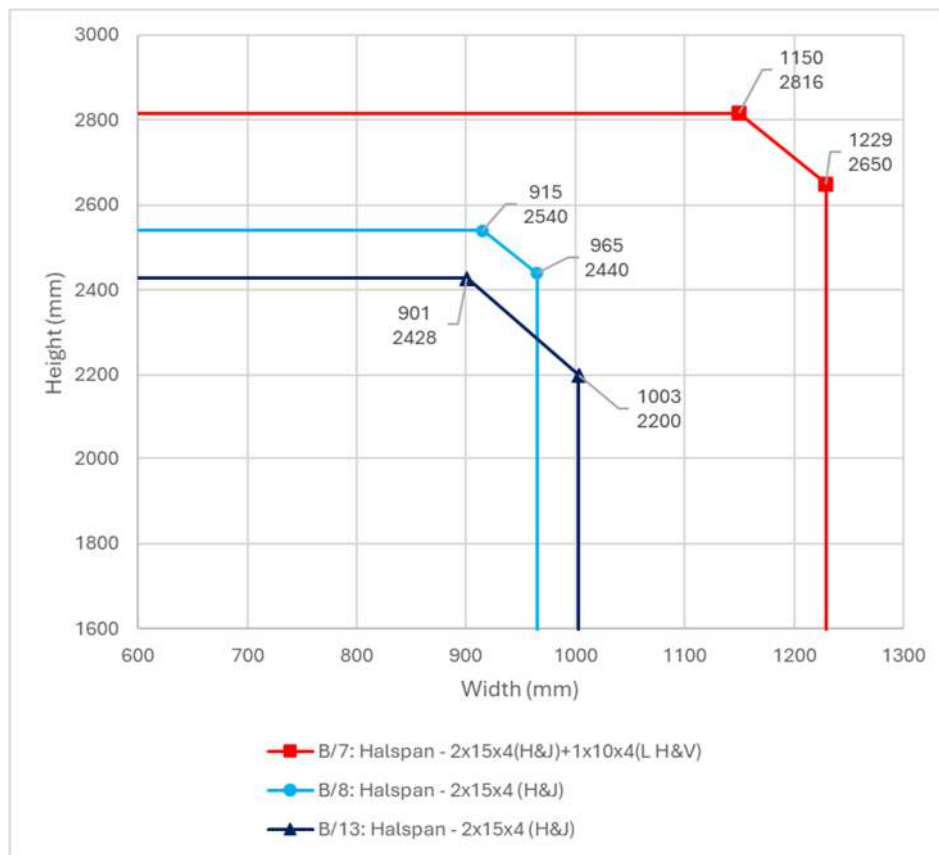

Halspan Intumescent Specification for ULSASD Leaf 1 with Frame 1		
Intumescent Spec. Reference (Test Reference)	Make / Type	Location & Size
B/7 (CFR1802131)	Halspan SLS	Head & Jambs: 2no 15x4. Fitted in frame reveal, centrally and 10mm apart Leaf head and vertical edges: 1no 10x4. Fitted centrally in leaf edges
B/8 (RF13167)	Halspan SLS	Head & Jambs: 2no 15x4. Fitted in frame reveal, centrally and 10mm apart
B/13 (F15273)	Halspan SLS	Head & Jambs: 2no 15x4. Fitted in frame reveal, centrally and 10mm apart

Leaf size envelopes for ULSASD using Leaf 1 and Frame 1 with Lorient seals

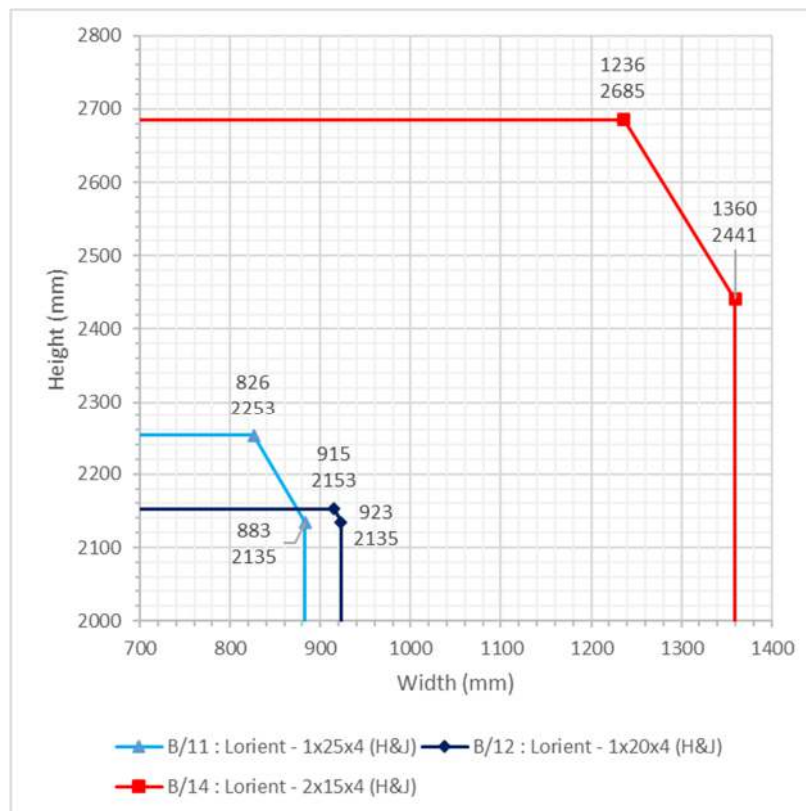

Lorient Intumescent Specification for ULSASD Leaf 1 with Frame 1		
Intumescent Spec. Reference (Test Reference)	Make / Type	Location & Size
B/11 (RF03041A)	LP2504 Type 617 ¹	Head & Jambs: 1no 25x4. Fitted in frame reveal
B/12 (RF03041B)	LP2004 Type 617 ¹	Head & Jambs: 1no 20x4. Fitted in frame reveal
B/14 (RF07128A)	LP1504 Type 617	Head & Jambs: 2no 15x4. Fitted in frame reveal and 10 mm apart

Note

1. Test references RF03041A and RF03041B were carried out using Lorient Palusol intumescent seals. Comparisons have been made between the performance of test references RF0006A and RF06005A with integrity performances of 60 and 75 minutes respectively (both ULSASD using 2no 15x4mm Palusol intumescent seals fitted in the frame reveals) against test reference RF07128A with integrity performance of 72 minutes (ULSASD using 2no 15x4mm Lorient 617 type intumescent seals fitted in the frame reveals). There were differences in the tested leaf size, with RF07128A being a larger tested leaf, which would be considered to be a more onerous test. It is therefore the opinion of Warringtonfire that for the designs considered herein, when the tested intumescent was Lorient Palusol that Lorient Type 617 can be used at the same intumescent sizes. The above table states the permitted intumescent type.

Leaf size envelopes for ULSASD using Leaf 1 and frame 1 with ISL or Mann McGowan seals

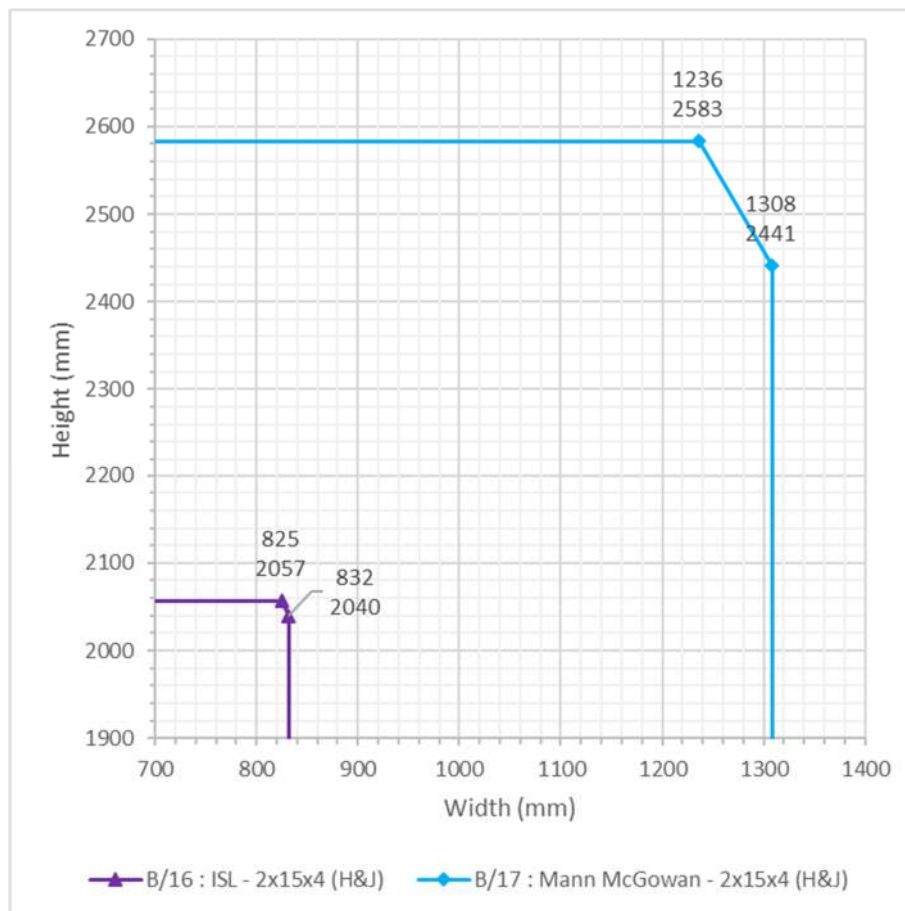

ISL or Mann McGowan Intumescent Specification for ULSASD Leaf 1 with Frame 1		
Intumescent Spec. Reference (Test Reference)	Make / Type	Location & Size
B/16 (RF01056B)	ISL Therm-A-Seal	Head & Jambs: 2no 15x4. Fitted in frame reveal and 10mm apart
B/17 (RF07128B)	Mann McGowan Pyrostrip100	Head & Jambs: 2no 15x4. Fitted in frame reveal and 10mm apart

Leaf size envelopes for ULSASD using Leaf 1 and Frame 1 with Pyroplex seals

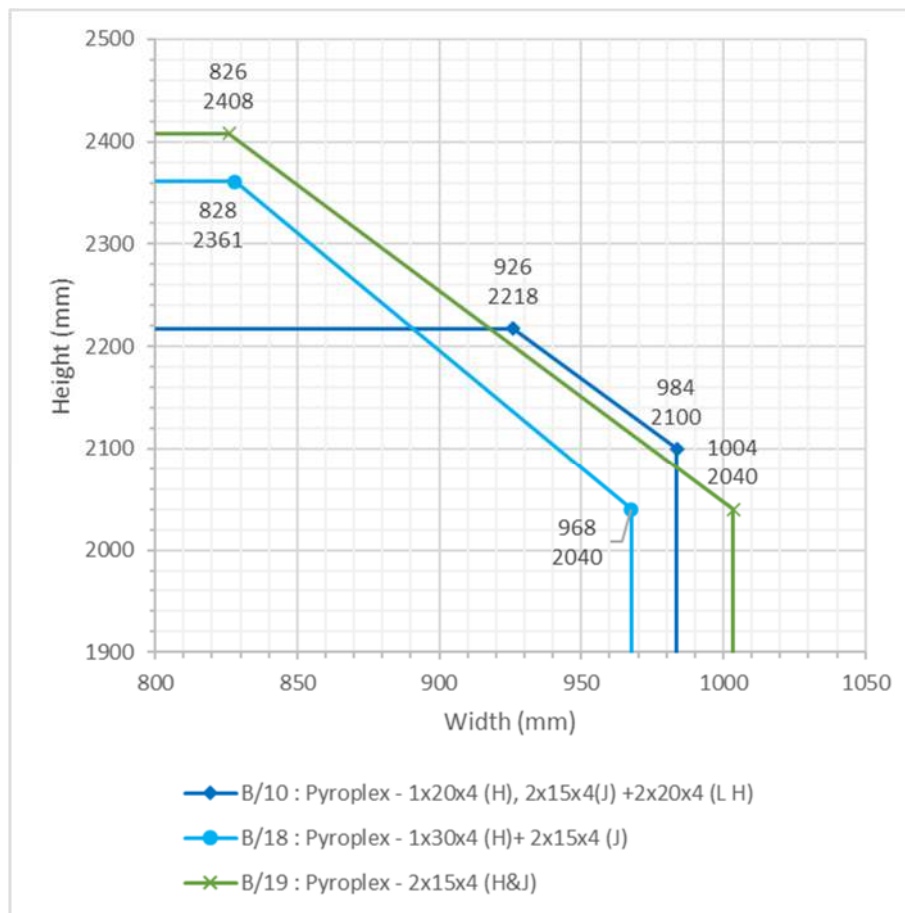

Pyroplex Intumescent Specification for ULSASD Leaf 1 with Frame 1		
Intumescent Spec. Reference (Test Reference)	Make / Type	Location & Size
B/10 (WF504390)	Pyroplex 8600 8700 / 30155 30156	Head: 1no 20x4. Fitted in frame reveal Jamb: 2no 15x4. Fitted in frame reveal and 10mm apart Leaf Head: 2no 20x4. Fitted in leaf head and 8mm apart
B/18 (RF02018 RevA)	Pyroplex 3009412 8721	Head: 1no 30x4. Fitted in frame head reveal Jamb: 2no 15x4. Fitted in frame jamb reveal centrally and 10mm apart
B/19 (CFR2103161)	Pyroplex 8700 / 30155	Head & Jamb: 2no 15x4. Fitted in frame reveal and 10mm apart

Leaf size envelopes for ULSASD using Leaf 1 and Frame 1 with STS seals.

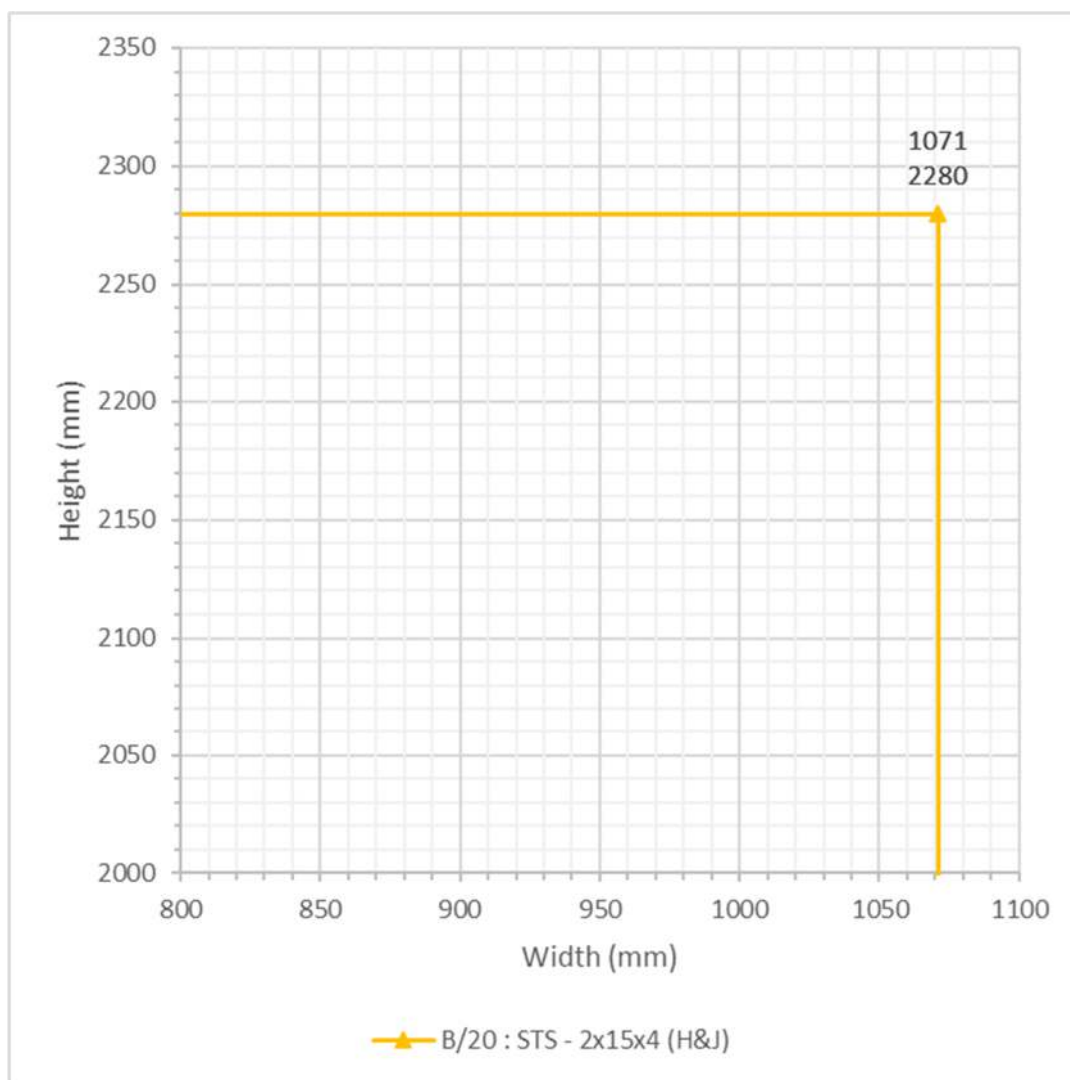

STS Intumescent Specification for ULSASD Leaf 1 with Frame 1		
Intumescent Spec. Reference (Test Reference)	Make / Type	Location & Size
B/20 (BMT/FEP/F15163)	STS ST1504FO	Head & Jamb: 2no 15x4. Fitted in frame reveal and 10mm apart

4.5.8.2 Leaf 1 + Frame 2 Doorset

Leaf size envelopes for ULSASD using Leaf 1 and Frame 2 using Halspan and Lorient seals.

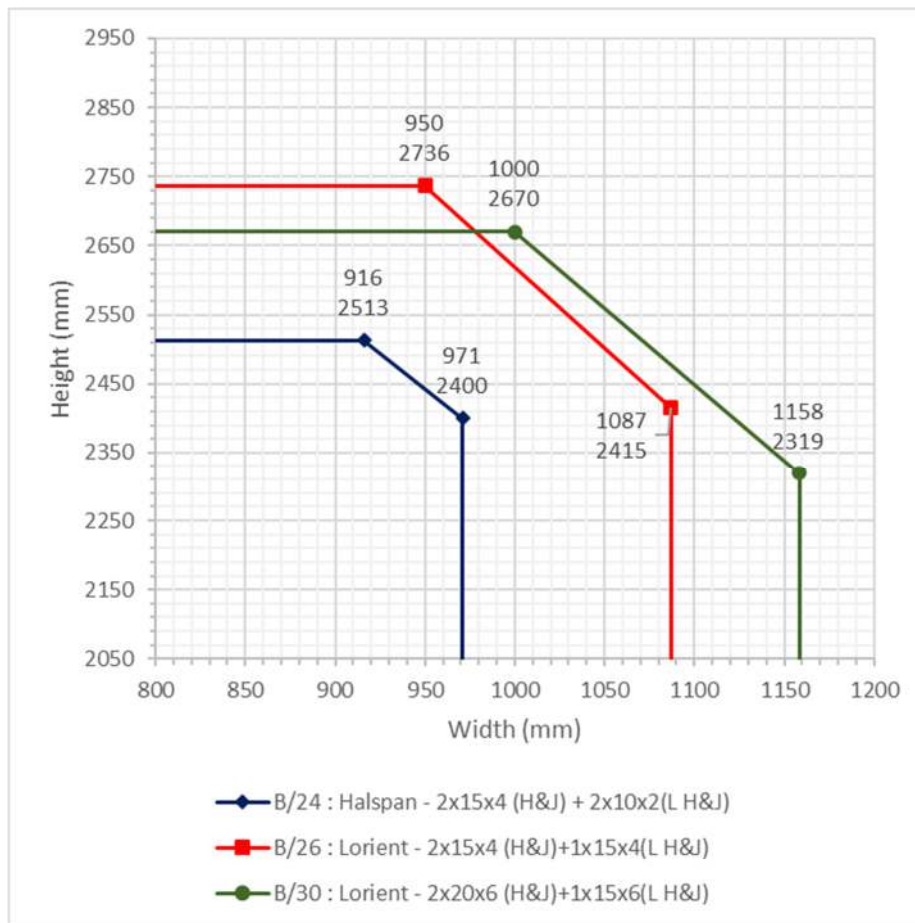

Halspan and Lorient Intumescent Specification for ULSASD Leaf 1 with Frame 2		
Intumescent Spec. Reference (Test Reference)	Make / Type	Location & Size
B/24 (CFR1809241)	Halspan SLS Halspan MAP	Head & Jambs: 2no 15x4. Fitted in frame reveal, centrally and 10mm apart Leaf head and vertical edges: 2no layers 10x2. Fitted in a 10x4 rebate centrally in leaf edges
B/26 (FRR-2009/2351)	Lorient LP1504	Head & Jambs: 2no 15x4. Fitted in frame reveal, centrally and 10mm apart Leaf head and vertical edges: 1no 15x4. Fitted centrally in leaf edges

Halspan and Lorient Intumescent Specification for ULSASD Leaf 1 with Frame 2		
Intumescent Spec. Reference (Test Reference)	Make / Type	Location & Size
B/30 (FRR-2102/4628A)	Lorient LP2006 Lorient LP1506	Head: 2no 20x6. Fitted in frame head reveal, centrally and 15mm apart Jamb: 2no 20x6. Fitted in frame jamb reveal, centrally and 6mm apart Leaf head and vertical edges: 1no 15x6. Fitted centrally in leaf edges

4.5.8.3 Leaf 1 + Frame 3 Doorset

Leaf size envelopes for ULSASD using Leaf 1 and Frame 3 using Halspan seals.

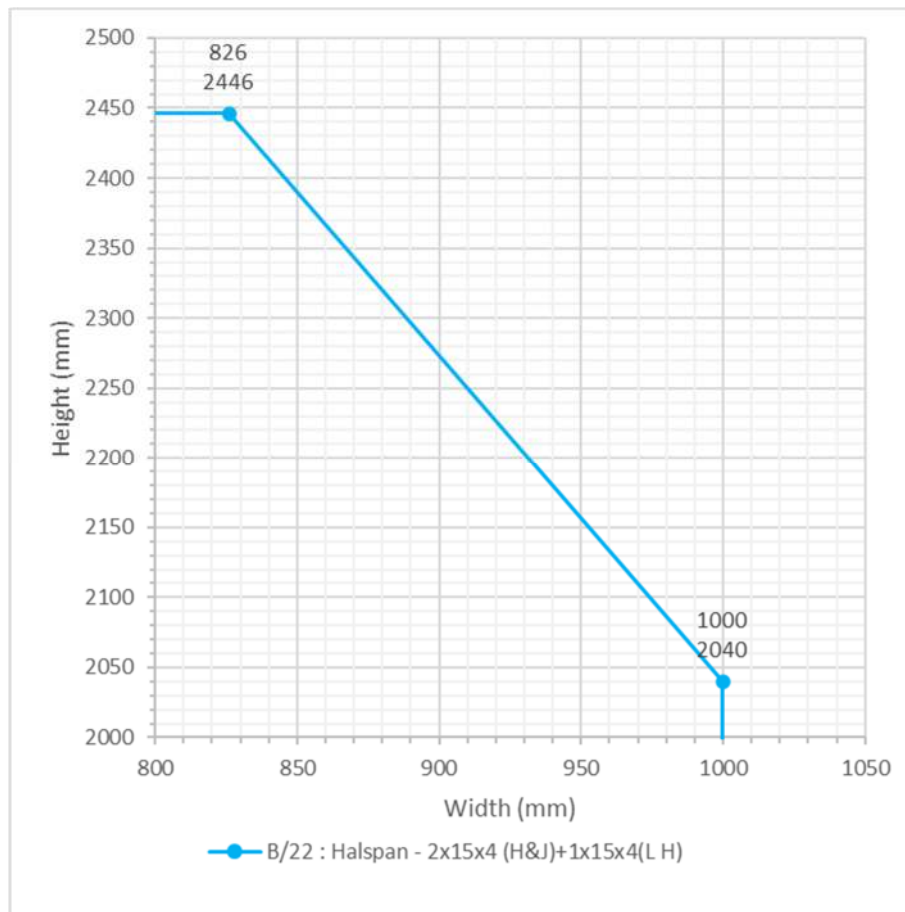

Halspan Intumescent Specification for ULSASD Leaf 1 with Frame 3		
Intumescent Spec. Reference (Test Reference)	Make / Type	Location & Size
B/22 (CFR2211141 LH)	Halspan SLS	Head & Jamb: 2no 15x4. Fitted in frame reveal, centrally and 10mm apart Leaf head: 1no 15x4. Fitted centrally in leaf edge

Leaf size envelopes for ULSASD using Leaf 1 and Frame 3 using Lorient seals.

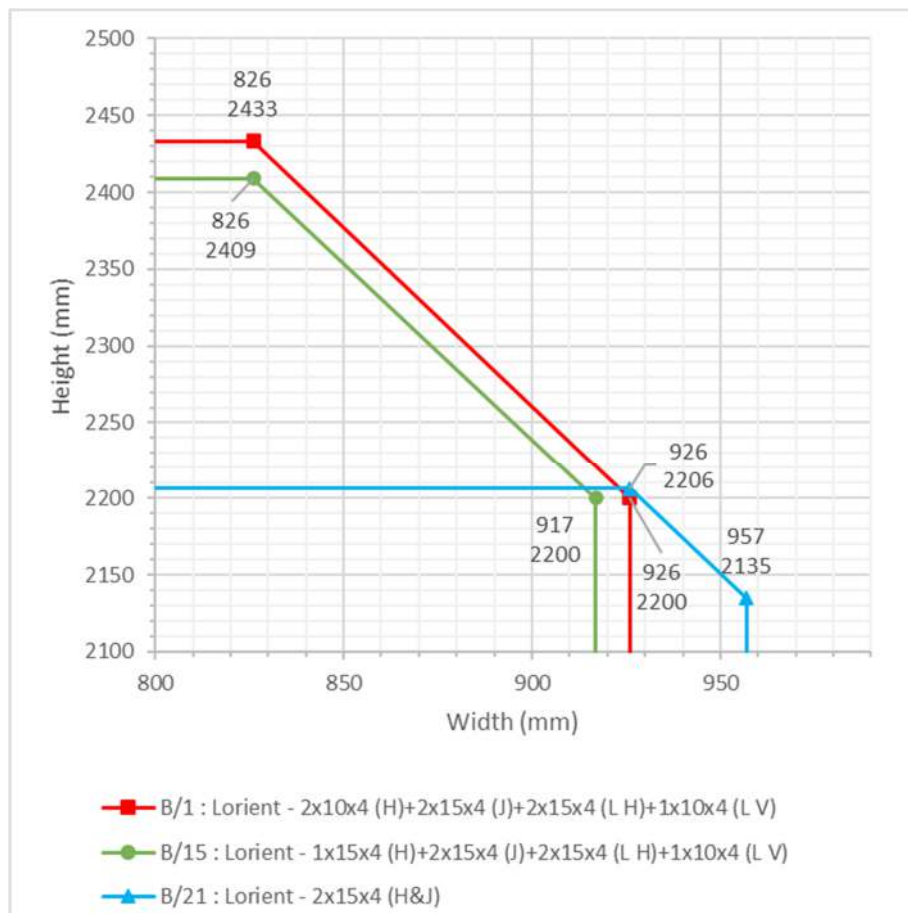

Lorient Intumescent Specification for ULSASD Leaf 1 with Frame 3		
Intumescent Spec. Reference (Test Reference)	Make / Type	Location & Size
B/1 (WF509420)	Lorient LP1004	Head: 2no 10x4. Fitted in frame head reveal, centrally and 25mm apart
	Lorient LP1504	Jamb: 2no 15x4. Fitted in frame jamb reveal, centrally and 10mm apart
	Lorient LP1504	Leaf heads: 2no 15x4. Fitted in leaf heads, centrally and 10mm apart
	Lorient LP1004	Leaf hanging edges: 1no 10x4. Fitted centrally in leaf edges

Lorient Intumescent Specification for ULSASD Leaf 1 with Frame 3		
Intumescent Spec. Reference (Test Reference)	Make / Type	Location & Size
B/15 (WF509421)	Lorient LP1504	Head: 1no 15x4. Fitted in frame head reveal, centrally.
	LP1504	Jamb: 2no 15x4. Fitted in frame jamb reveal, centrally and 10mm apart
	LP1504	Leaf heads: 2no 15x4. Fitted in leaf heads, centrally and 10mm apart
	LP1004	Leaf hanging edges: 1no 10x4. Fitted centrally in leaf edges
B/21 (F15012B)	Lorient LP1504	Head & Jamb: 2no 15x4. Fitted in frame reveal, centrally and 10mm apart

4.5.8.4 Leaf 1 + Frame 4 or 5 Doorset

For leaf size envelopes for ULSASD using Leaf 1 and Frame 4 or 5 using Halspan seals see intumescent specification B/22 within section 4.5.8.3.

4.5.8.5 Leaf 1 + Frame 7 Doorset

For leaf size envelopes for ULSASD using Leaf 1 and Frame 7 see intumescent specifications B/7, B/8, B/10, B/14, B/16, B/17, B/19 & B/20 within section 4.5.8.1.

4.5.9 DASD Configuration: Leaf Sizes & Intumescent Specification

4.5.9.1 Leaf 1 + Frame 1 Doorset

For leaf size envelopes for DASD using Leaf 1 and Frame 1 see intumescent specifications B/1, B/10, B/14, B/15, B/18, B/19, B/30 within sections 4.5.8.1 and 4.5.8.2 and 4.5.8.3.

4.5.9.2 Leaf 1 + Frame 2 Doorset

For leaf size envelopes for DASD using Leaf 1 and Frame 2 see intumescent specifications B/26 and B/30 within section 4.5.8.2.

4.5.9.3 Leaf 1 + Frame 3 Doorset

For leaf size envelopes for DASD using Leaf 1 and Frame 3 see intumescent specifications B/1 & B/15 within section 4.5.8.3.

4.5.9.4 Leaf 1 + Frame 4, 5, or 7 Doorset

Not Permitted.

4.5.10 LSASD+OP Configuration: Leaf Sizes & Intumescent Specification

4.5.10.1 Leaf 1 + Frame 1 Doorset

Leaf size envelopes for LSASD+OP using Leaf 1 and Frame 1

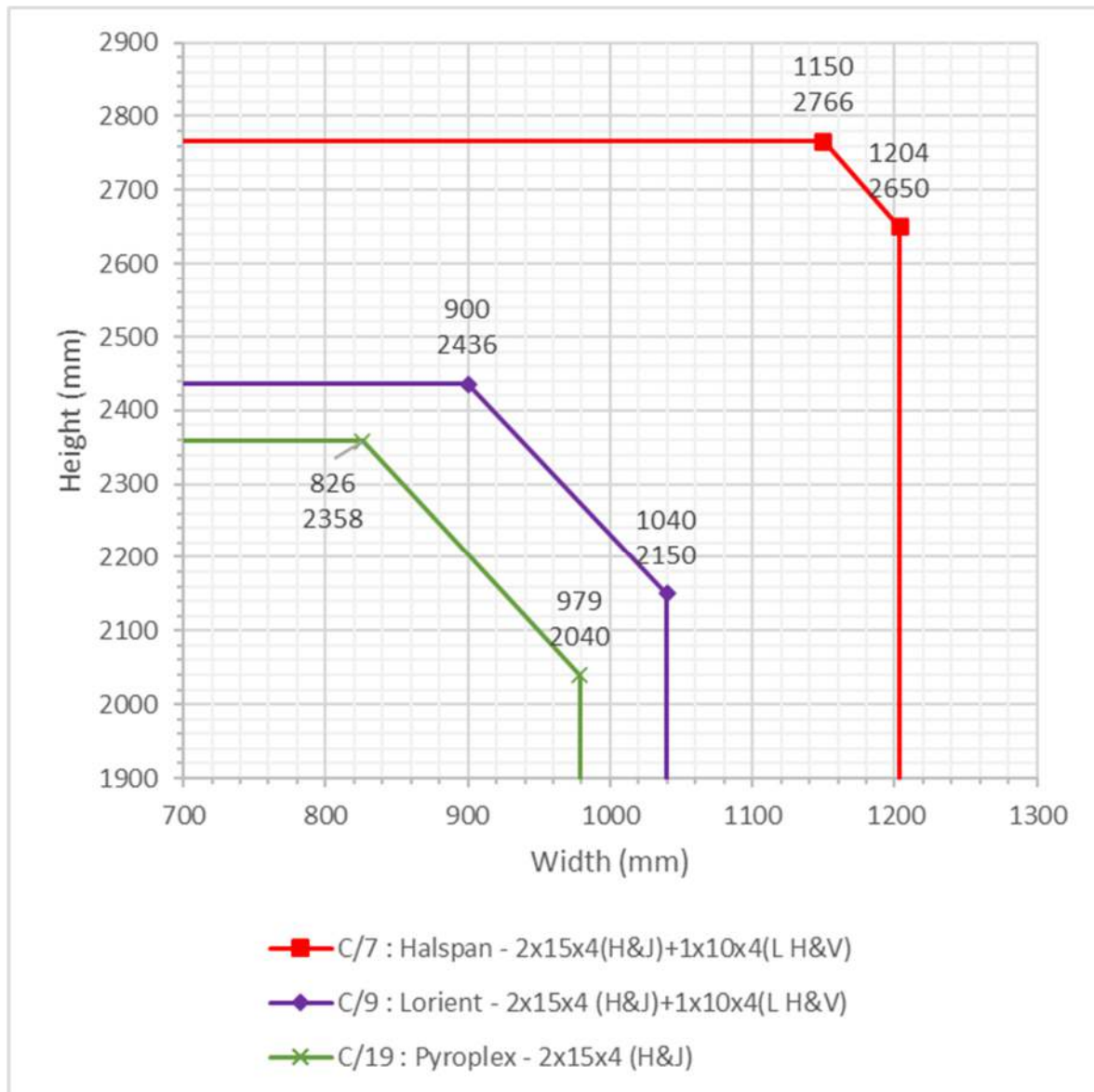

Intumescent Specification for LSASD + OP Leaf 1 with Frame 1		
Intumescent Spec. Reference (Test Reference)	Make / Type	Location & Size
C/7 (CFR1802131_2)	Halspan SLS	<p>Frame Head & Jambs: 2no 15x4. Fitted in frame reveal, centrally and 10mm apart</p> <p>Vertical leaf edges: 1no 10x4. Fitted centrally in leaf edges</p> <p>Leaf head to overpanel junction: Option a) With equal rebated flush overpanel: Overpanel and leaf head: 1no 15x4. Fitted centrally in rebate of overpanel bottom edge 1no 15x4. Fitted centrally in upstand of overpanel bottom edge 1no 10x4. Fitted centrally in rebate of leaf top edge</p> <p>Option b) With flat lipping flush overpanel: Overpanel and leaf head: 2no 15x4: Fitted 10mm apart and centrally to overpanel bottom edge. 1no 10x4 Fitted centrally to the leaf top edge</p>

Intumescent Specification for LSASD + OP Leaf 1 with Frame 1		
Intumescent Spec. Reference (Test Reference)	Make / Type	Location & Size
C/9 (RF98051)	Lorient LP1504 / LP1004	Head & Jambs: 2no 15x4. Fitted in frame reveal and 8mm apart Vertical leaf edges: 1no 10x4. Fitted centrally in leaf edges Leaf head to overpanel junction: Option a) With equal rebated flush overpanel: Overpanel and leaf head: 1no 15x4. Fitted centrally in rebate of overpanel bottom edge 1no 15x4. Fitted centrally in upstand of overpanel bottom edge 1no 10x4. Fitted in the corner of the rebate of leaf top edge Option b) With flat lipping flush overpanel: Overpanel and leaf head: 2no 15x4: Fitted 10mm apart and centrally to overpanel bottom edge. 1no 10x4 Fitted centrally to the leaf top edge

Intumescent Specification for LSASD + OP Leaf 1 with Frame 1		
Intumescent Spec. Reference (Test Reference)	Make / Type	Location & Size
C/19 (CFR2103161)	Pyroplex 8700 / 30155	Head & Jambs: 2no 15x4. Fitted in frame reveal and 10mm apart Leaf head to overpanel junction: Option a) With equal rebated flush overpanel: Overpanel and leaf head: 1no 15x4. Fitted centrally in upstand of overpanel bottom edge 1no 15x4. Fitted centrally in upstand of leaf top edge Option b) With flat lipping flush overpanel: Overpanel and leaf head: 2no 15x4: Fitted 10mm apart and centrally to overpanel bottom edge.

4.5.10.2 Leaf 1 + Frame 2, 3, 4, 5, or 7 Doorset

Not Permitted.

4.5.11 ULSASD+OP Configuration: Leaf Sizes & Intumescent Specification

4.5.11.1 Leaf 1 + Frame 1 Doorset

Leaf size envelopes for ULSASD+OP using Leaf 1 and Frame 1

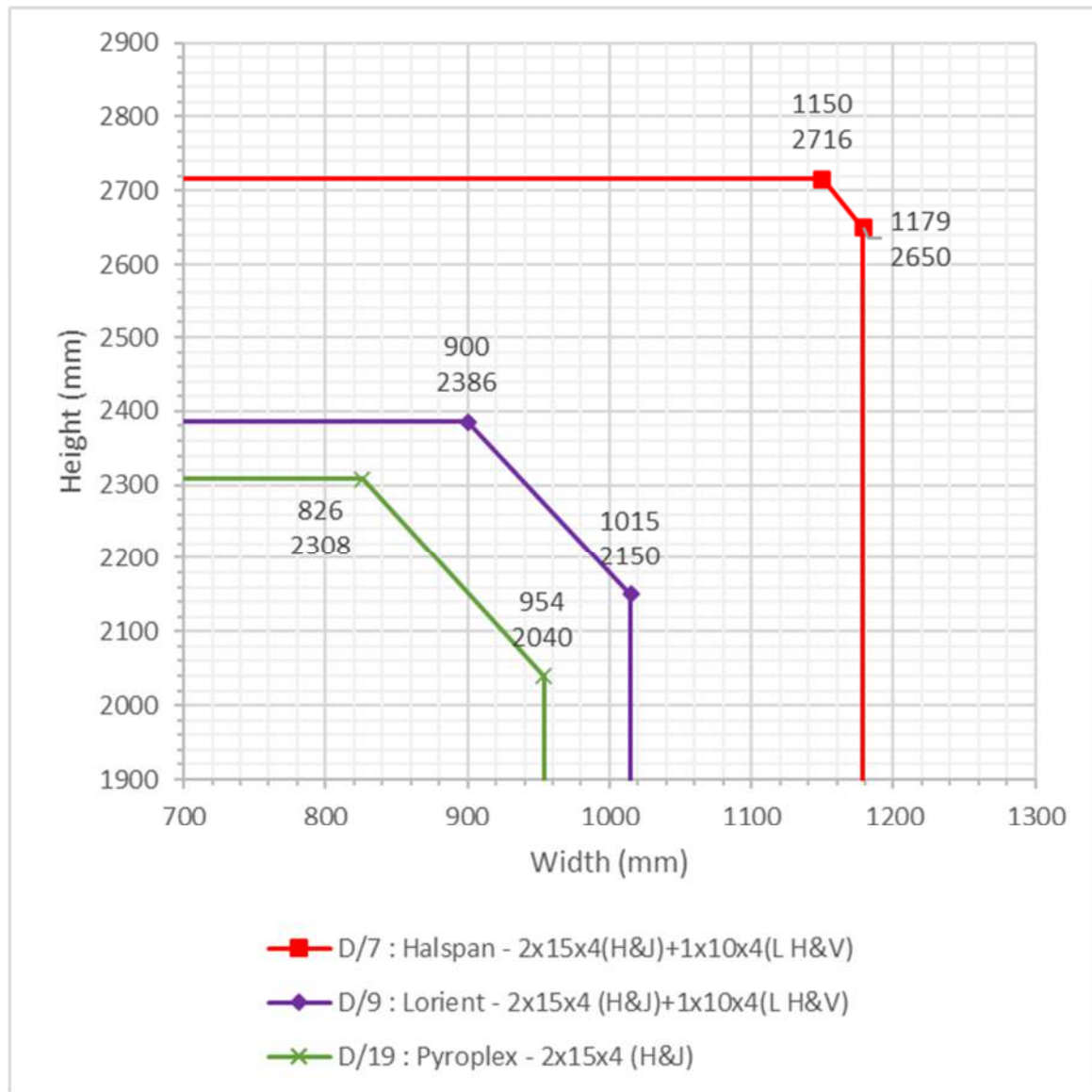

Intumescent Specification for ULSASD + OP Leaf 1 with Frame 1		
Intumescent Spec. Reference (Test Reference)	Make / Type	Location & Size
D/7 (CFR1802131_2)	Halspan SLS	<p>Frame Head & Jambs: 2no 15x4. Fitted in frame reveal, centrally and 10mm apart</p> <p>Vertical leaf edges: 1no 10x4. Fitted centrally in leaf edges</p> <p>Leaf head to overpanel junction: Option a) With equal rebated flush overpanel: Overpanel and leaf head: 1no 15x4. Fitted centrally in rebate of overpanel bottom edge 1no 15x4. Fitted centrally in upstand of overpanel bottom edge 1no 10x4. Fitted centrally in rebate of leaf top edge</p> <p>Option b) With flat lipping flush overpanel: Overpanel and leaf head: 2no 15x4: Fitted 10mm apart and centrally to overpanel bottom edge. 1no 10x4 Fitted centrally to the leaf top edge</p>

Intumescent Specification for ULSASD + OP Leaf 1 with Frame 1		
Intumescent Spec. Reference (Test Reference)	Make / Type	Location & Size
D/9 (RF98051)	Lorient LP1504 / LP1004	<p>Head & Jambs: 2no 15x4. Fitted in frame reveal and 8mm apart</p> <p>Vertical leaf edges: 1no 10x4. Fitted centrally in leaf edges</p> <p>Leaf head to overpanel junction: Option a) With equal rebated flush overpanel: Overpanel and leaf head: 1no 15x4. Fitted centrally in rebate of overpanel bottom edge 1no 15x4. Fitted centrally in upstand of overpanel bottom edge 1no 10x4. Fitted in the corner of the rebate of leaf top edge</p> <p>Option b) With flat lipping flush overpanel: Overpanel and leaf head: 2no 15x4: Fitted 10mm apart and centrally to overpanel bottom edge. 1no 10x4 Fitted centrally to the leaf top edge</p>

Intumescent Specification for ULSASD + OP Leaf 1 with Frame 1		
Intumescent Spec. Reference (Test Reference)	Make / Type	Location & Size
D/19 (CFR2103161)	Pyroplex 8700 / 30155	<p>Head & Jambs: 2no 15x4. Fitted in frame reveal and 10mm apart</p> <p>Leaf head to overpanel junction: Option a) With equal rebated flush overpanel: Overpanel and leaf head: 1no 15x4. Fitted centrally in upstand of overpanel bottom edge 1no 15x4. Fitted centrally in upstand of leaf top edge</p> <p>Option b) With flat lipping flush overpanel: Overpanel and leaf head: 2no 15x4: Fitted 10mm apart and centrally to overpanel bottom edge.</p>

4.5.11.2 Leaf 1 + Frame 2, 3, 4, 5, or 7 Doorset

Not Permitted.

4.5.12 LSADD Configuration: Leaf Sizes & Intumescent Specification

4.5.12.1 Leaf 1 + Frame 1 Doorset

Leaf size envelopes for LSADD using Leaf 1 and Frame 1 with Halspan seals

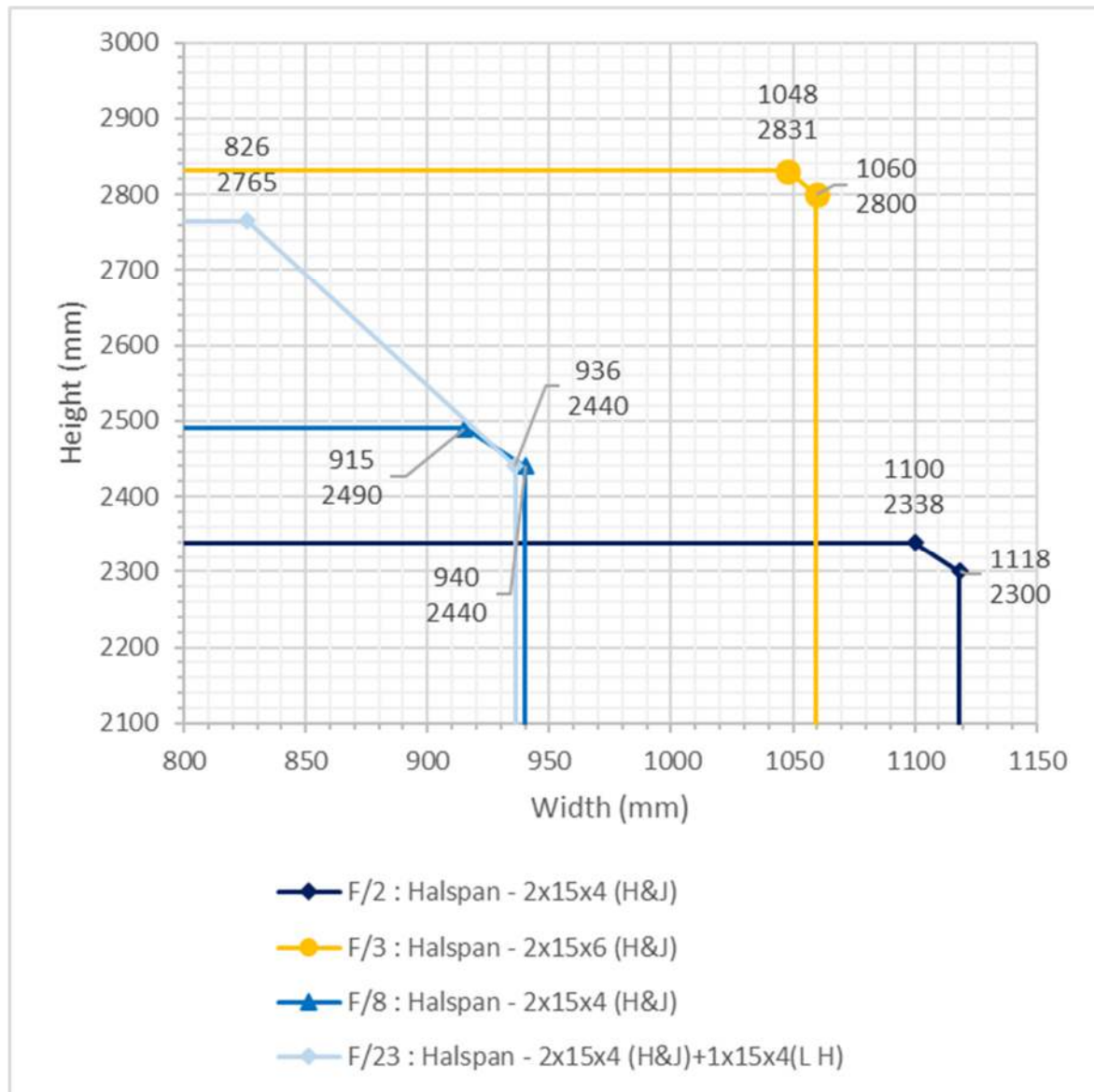

Halspan Intumescent Specification for LSADD Leaf 1 with Frame 1		
Intumescent Spec. Reference (Test Reference)	Make / Type	Location & Size
F/2 (LP-636.7/09)	Halspan SLS	Head & Jambs: 2no 15x4. Fitted in frame reveal, centrally and 10mm apart Meeting Edge: 2no 15x4, fitted centrally and 10mm apart in one leaf.
F/3 (CFR1707241)	Halspan SLS	Head & Jambs: 2no 15x6 (each comprising 15x2 graphite (SLS misc 105) under 15x4). Fitted in frame reveal, centrally and 10mm apart Meeting Edge: 2no 15x4, fitted centrally and 10mm apart in one leaf 1no 10x4, fitted centrally in other leaf
F/8 (RF13167)	Halspan SLS	Head & Jambs: 2no 15x4. Fitted in frame reveal, centrally and 10mm apart Meeting Edge: 2no 15x4, fitted centrally and 10mm apart in one leaf.
F/23 (CFR2211141 RH)	Halspan SLS	Head & Jambs: 2no 15x4. Fitted in frame reveal and 10mm apart Leaf head: 1no 15x4. Fitted centrally in leaf edge Meeting Edge: 2no 15x4, fitted centrally and 10mm apart in one leaf 1no 15x4, fitted centrally in other leaf

Leaf size envelopes for LSADD using Leaf 1 and Frame 1 with Lorient seals

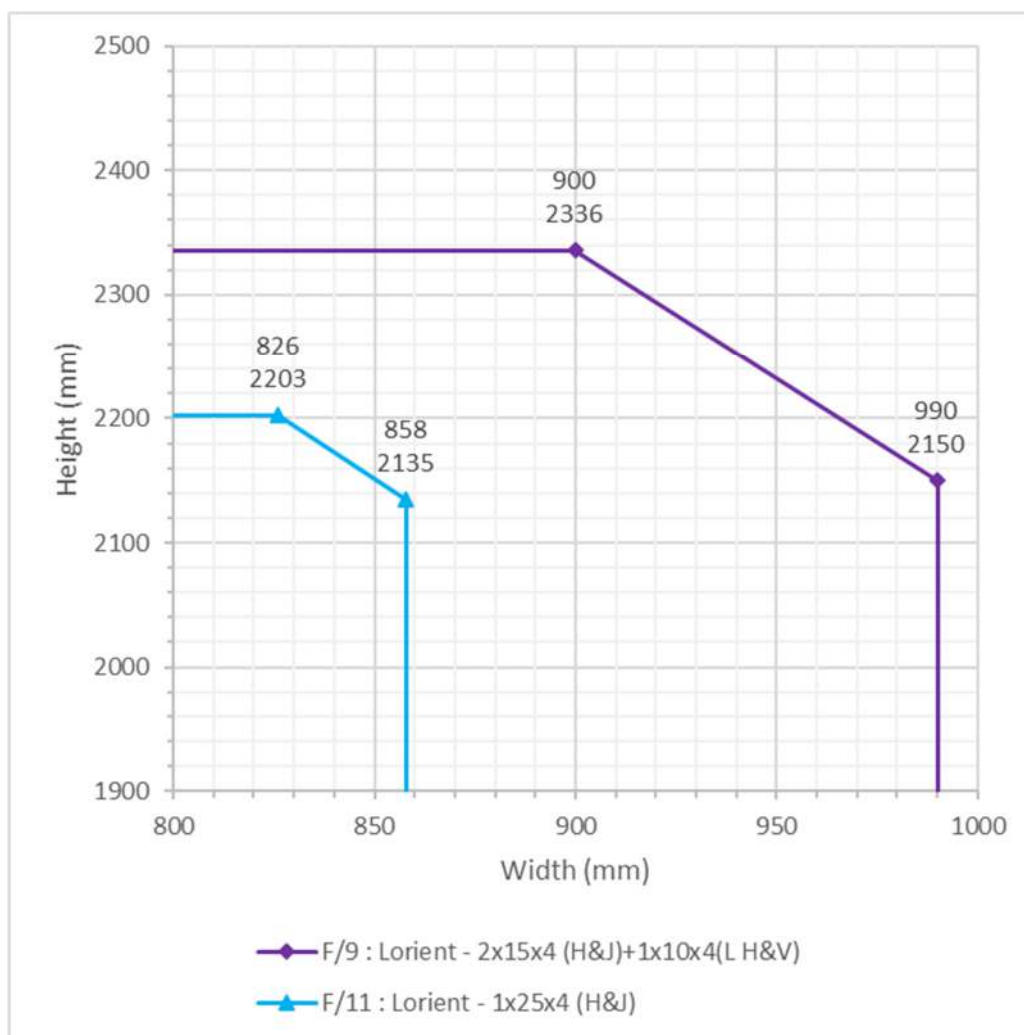

Lorient Intumescent Specification for LSADD Leaf 1 with Frame 1		
Intumescent Spec. Reference (Test Reference)	Make / Type	Location & Size
F/9 (RF98051)	Lorient LP1504 / LP1004	<p>Head & Jambs: 2no 15x4. Fitted in frame reveal and 8mm apart</p> <p>Leaf head and vertical hanging edges: 1no 10x4. Fitted centrally in leaf edges</p> <p>Meeting Edge: 2no 15x4, fitted centrally and 8mm apart in one leaf 1no 10x4, fitted centrally in other leaf</p>

Lorient Intumescent Specification for LSADD Leaf 1 with Frame 1		
Intumescent Spec. Reference (Test Reference)	Make / Type	Location & Size
F/11 (RF03041A)	LP2504 Type 617 ¹	Head & Jambs: 1no 25x4. Fitted in frame reveal Meeting Edge: 1no 25x4. fitted centrally in one leaf

Note

1. Test reference RF03041A was carried out using Lorient Palusol intumescent seals. Comparisons have been made between the performance of test references RF0006A and RF06005A with integrity performances of 60 and 75 minutes respectively (both ULSASD using 2no 15x4mm Palusol intumescent seals fitted in the frame reveals) against test reference RF07128A with integrity performance of 72 minutes (ULSASD using 2no 15x4mm Lorient 617 type intumescent seals fitted in the frame reveals). There were differences in the tested leaf size, with RF07128A being a larger tested leaf, which would be considered to be a more onerous test. It is therefore the opinion of Warringtonfire that for the designs considered herein, when the tested intumescent was Lorient Palusol that Lorient Type 617 can be used at the same intumescent sizes. The above table states the permitted intumescent type.

Leaf size envelopes for LSADD using Leaf 1 and Frame 1 with Pyroplex seals

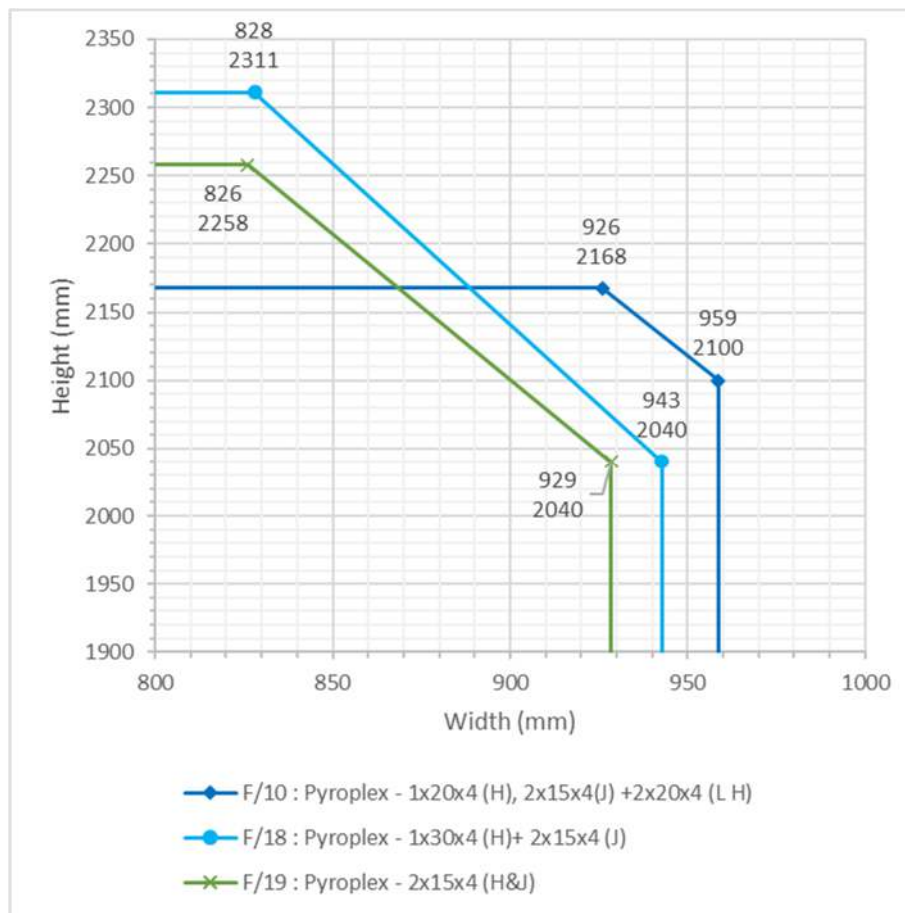

Pyroplex Intumescent Specification for LSADD Leaf 1 with Frame 1		
Intumescent Spec. Reference (Test Reference)	Make / Type	Location & Size
F/10 (WF504390)	Pyroplex 8600	Head: 1no 20x4. Fitted in frame reveal
	8700 / 30155	Jambs: 2no 15x4. Fitted in frame reveal and 10mm apart
	30156	Leaf Head: 2no 20x4. Fitted in leaf head and 8mm apart
	8700 / 30155	Meeting Edge: 2no 15x4, fitted centrally and 10mm apart in one leaf

Pyroplex Intumescent Specification for LSADD Leaf 1 with Frame 1		
Intumescent Spec. Reference (Test Reference)	Make / Type	Location & Size
F/18 (RF02018 RevA)	Pyroplex 3009412 8721 8721	Head: 1no 30x4. Fitted in frame head reveal Jamb: 2no 15x4. Fitted in frame jamb reveal centrally and 10mm apart Meeting Edge: 2no 15x4, fitted centrally and 10mm apart in one leaf
F/19 (CFR2103161)	Pyroplex 8700 / 30155	Head & Jamb: 2no 15x4. Fitted in frame reveal and 10mm apart Meeting edge junction: Option 1) With equal rebated meeting edge: Meeting Edge: 2no 15x4. 1no fitted centrally in upstand of each leaf meeting edge Option 2) With flat lipping meeting edge: Meeting Edge: 2no 15x4, fitted centrally and 10mm apart in one leaf

Leaf size envelopes for LSADD using Leaf 1 and Frame 1 with STS seals.

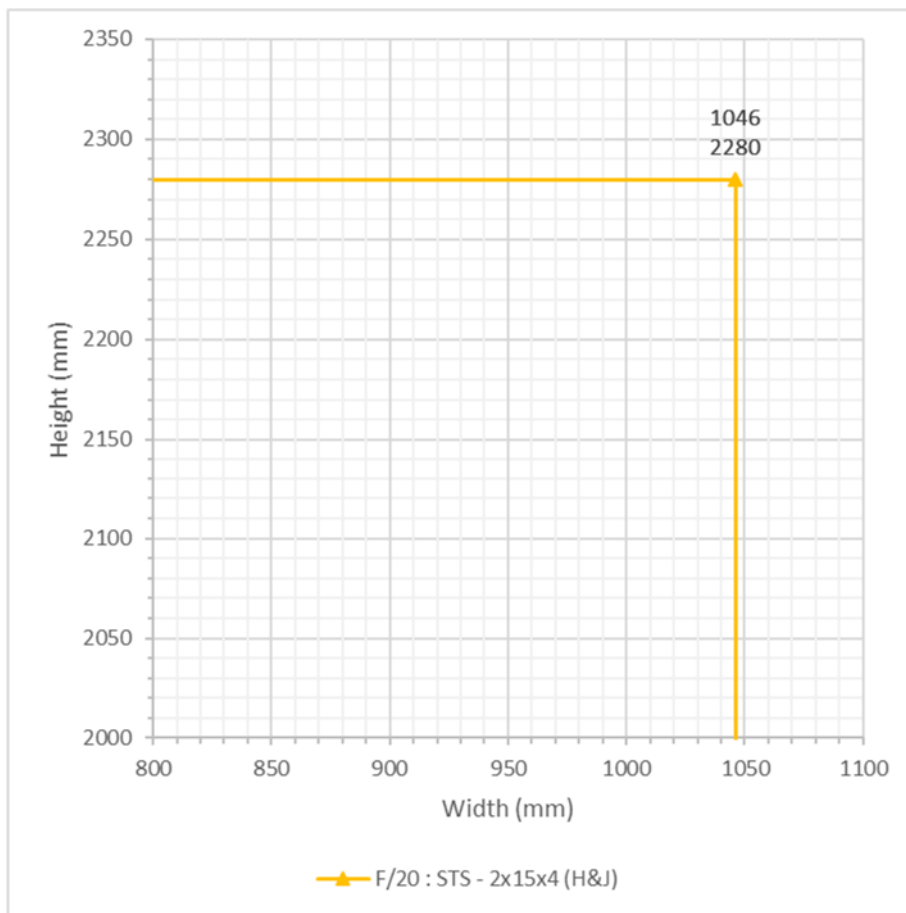

STS Intumescent Specification for LSADD Leaf 1 with Frame 1		
Intumescent Spec. Reference (Test Reference)	Make / Type	Location & Size
F/20 (BMT/FEP/F15163)	STS ST1504FO	Head & Jamb: 2no 15x4. Fitted in frame reveal and 10mm apart Meeting Edge: 2no 15x4, fitted centrally and 10mm apart in one leaf

4.5.12.2 Leaf 1 + Frame 2 Doorset

Leaf size envelopes for LSADD using Leaf 1 and Frame 2 using Halspan and Firestop seals.

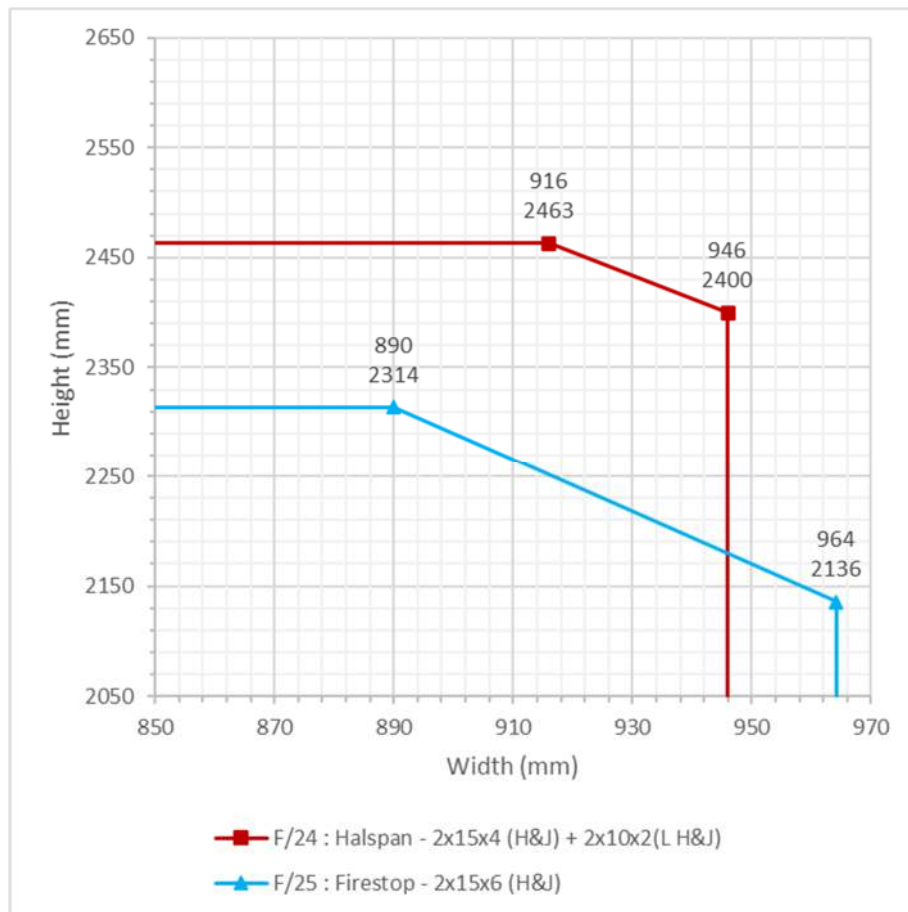

Halspan and Firestop Intumescent Specification for LSADD Leaf 1 with Frame 2		
Intumescent Spec. Reference (Test Reference)	Make / Type	Location & Size
F/24 (CFR1809241)	Halspan SLS	Head & Jamb: 2no 15x4. Fitted in frame reveal, centrally and 10mm apart
	Halspan MAP	Leaf head and vertical hanging edges: 2no layers 10x2. Fitted in a 10x4 rebate centrally in leaf edges
	Halspan SLS	Leaf meeting edges: 2no 15x4. Fitted in frame reveal, centrally and 10mm apart in one leaf meeting edge
	Halspan MAP	2no layers 10x2. Fitted in a 10x4 rebate centrally in other leaf meeting edge

Halspan and Firestop Intumescent Specification for LSADD Leaf 1 with Frame 2		
Intumescent Spec. Reference (Test Reference)	Make / Type	Location & Size
F/25 (FRR-2010/2942)	Firestop FS438	Head & Jambs: 2no 15x6. Fitted in frame reveal, centrally and 8mm apart Meeting edge junction: Option 1) With equal rebated meeting edge: Meeting Edge: 2no 15x6. 1no fitted centrally in rebate of each leaf meeting edge Option 2) With flat lipping meeting edge: Meeting Edge: 2no 15x6. Fitted centrally and 8mm apart

Leaf size envelopes for LSADD using Leaf 1 and Frame 2 using Lorient seals.



Lorient Intumescent Specification for LSADD Leaf 1 with Frame 2		
Intumescent Spec. Reference (Test Reference)	Make / Type	Location & Size
F/26 (FRR-2009/2351)	Lorient LP1504	<p>Head & Jambs: 2no 15x4. Fitted in frame reveal, centrally and 10mm apart</p> <p>Leaf head and vertical hanging edges: 1no 15x4. Fitted centrally in leaf edges</p> <p>Leaf meeting edges: 2no 15x4. Fitted centrally and 10mm apart in one leaf meeting edge 1no 15x4. Fitted centrally in other leaf meeting edge</p>

Lorient Intumescent Specification for LSADD Leaf 1 with Frame 2		
Intumescent Spec. Reference (Test Reference)	Make / Type	Location & Size
F/29 (FRR-2110/1498)	Lorient LP1506	Head & Jambs: 2no 15x6. Fitted in frame reveal, centrally and 15mm apart
	Lorient LP1504	Leaf head and vertical hanging edges: 1no 15x4. Fitted centrally in leaf edges Leaf meeting edges: 2no 15x4. Fitted centrally and 15mm apart in one leaf meeting edge 1no 15x4. Fitted centrally in other leaf meeting edge
F/30 (FRR-2102/4628A)	Lorient LP2006	Head: 2no 20x6. Fitted in frame head reveal, centrally and 15mm apart
	Lorient LP1506	Jambs: 2no 20x6. Fitted in frame jamb reveal, centrally and 6mm apart
	Lorient LP2006	Leaf head and vertical hanging edges: 1no 15x6. Fitted centrally in leaf edges
	Lorient LP1506	Leaf meeting edges: 2no 20x6. Fitted centrally and 6mm apart in one leaf meeting edge 1no 15x6. Fitted centrally in other leaf meeting edge

4.5.12.3 Leaf 1 + Frame 3 Doorset

Leaf size envelopes for LSADD using Leaf 1 and Frame 3 using Halspan seals.

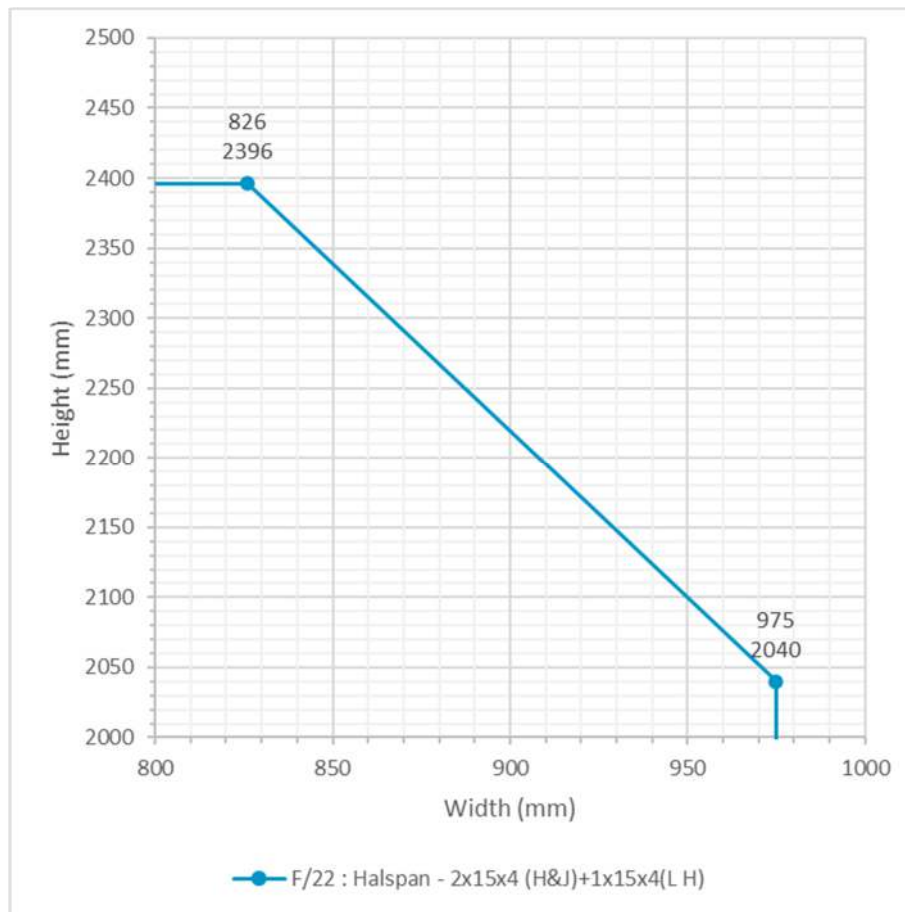

Halspan Intumescent Specification for LSADD Leaf 1 with Frame 3		
Intumescent Spec. Reference (Test Reference)	Make / Type	Location & Size
F/22 (CFR2211141 LH)	Halspan SLS	<p>Head & Jamb: 2no 15x4. Fitted in frame reveal, centrally and 10mm apart</p> <p>Leaf heads: 1no 15x4. Fitted centrally in leaf edges</p> <p>Meeting Edge: 2no 15x4. Fitted centrally and 10mm apart in one leaf. 1no 15x4. Fitted centrally in other leaf.</p>

Leaf size envelopes for LSADD using Leaf 1 and Frame 3 using Lorient seals.

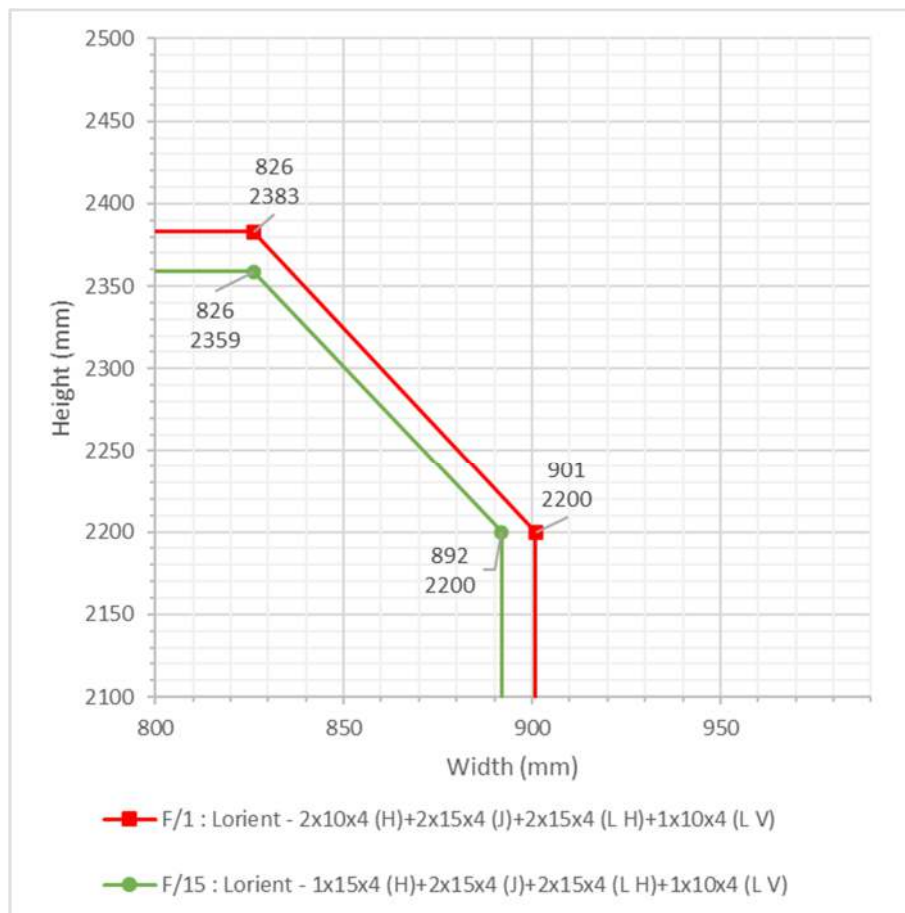

Lorient Intumescent Specification for LSADD Leaf 1 with Frame 3		
Intumescent Spec. Reference (Test Reference)	Make / Type	Location & Size
F/1 (WF509420)	Lorient LP1004	Head: 2no 10x4. Fitted in frame head reveal, centrally and 25mm apart
	Lorient LP1504	Jams: 2no 15x4. Fitted in frame jams reveal, centrally and 10mm apart
	Lorient LP1504	Leaf heads: 2no 15x4. Fitted in leaf heads, centrally and 10mm apart
	Lorient LP1004	Leaf hanging edges: 1no 10x4. Fitted centrally in leaf edges
	Lorient LP1504 LP1004	Meeting Edge: 2no 15x4. Fitted centrally and 10mm apart in one leaf. 1no 15x4. Fitted centrally in other leaf.

Lorient Intumescent Specification for LSADD Leaf 1 with Frame 3		
Intumescent Spec. Reference (Test Reference)	Make / Type	Location & Size
F/15 (WF509421)	Lorient LP1504	Head: 1no 15x4. Fitted in frame head reveal, centrally
	LP1504	Jamb: 2no 15x4. Fitted in frame jamb reveal, centrally and 10mm apart
	LP1504	Leaf heads: 2no 15x4. Fitted in leaf heads, centrally and 10mm apart
	LP1004	Leaf hanging edges: 1no 10x4. Fitted centrally in leaf edges
	LP1504	Meeting Edge: 2no 15x4. Fitted centrally and 10mm apart in one leaf.
	LP1004	1no 15x4. Fitted centrally in other leaf.

4.5.12.4 Leaf 1 + Frame 4 or 5 Doorset

For leaf size envelopes for LSADD using Leaf 1 and Frame 4 or 5 using Halspan seals see intumescent specification F/22 within section 4.5.12.3.

4.5.12.5 Leaf 1 + Frame 7 Doorset

For leaf size envelopes for LSADD using Leaf 1 and Frame 7 see intumescent specifications F/2, F/3, F/8, F/9, F/10, F/19, F/20 & F/23 within section 4.5.12.1.

4.5.13 ULSADD Configuration: Leaf Sizes & Intumescent Specification

4.5.13.1 Leaf 1 + Frame 1 Doorset

Leaf size envelopes for ULSADD using Leaf 1 and Frame 1 with Halspan seals

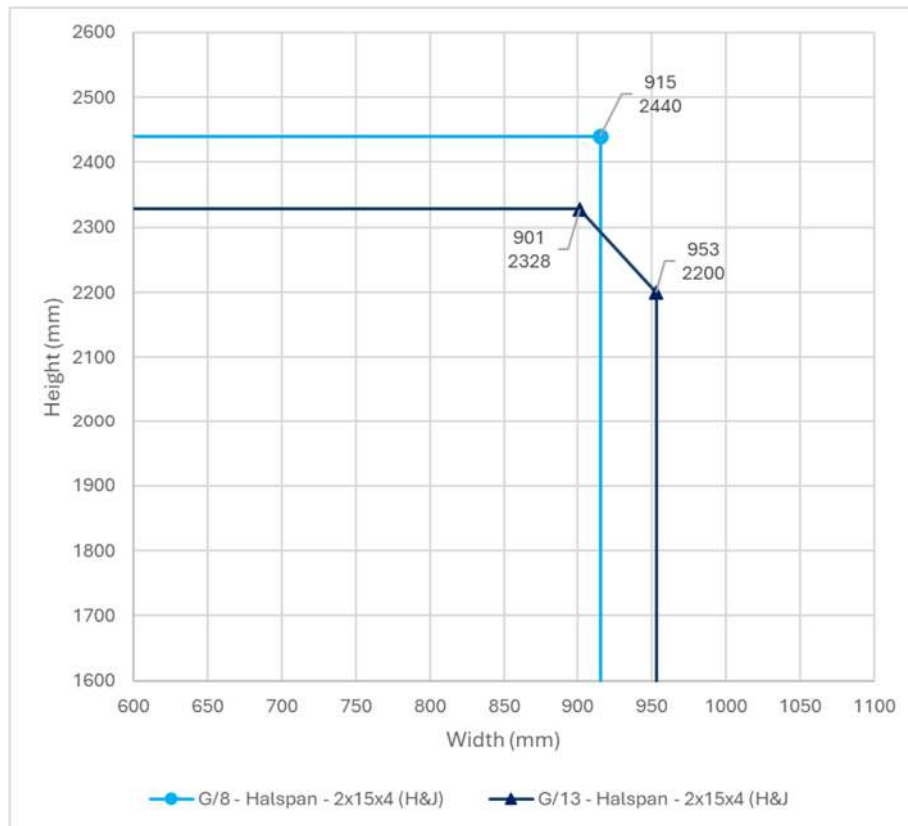

Halspan Intumescent Specification for ULSADD Leaf 1 with Frame 1		
Intumescent Spec. Reference (Test Reference)	Make / Type	Location & Size
G/8 (RF13167)	Halspan SLS	Head & Jambs: 2no 15x4. Fitted in frame reveal, centrally and 10mm apart Meeting Edge: 2no 15x4, fitted centrally and 10mm apart in one leaf.
G/13 (F15273)	Halspan SLS	Head & Jambs: 2no 15x4. Fitted in frame reveal, centrally and 10mm apart Meeting Edge: 2no 15x4, fitted centrally and 10mm apart in one leaf

For an additional leaf size envelope for ULSADD using Leaf 1 and Frame 1 see intumescent specification G/22 within section 4.5.13.3.

Leaf size envelopes for ULSADD using Leaf 1 and Frame 1 with Lorient seals

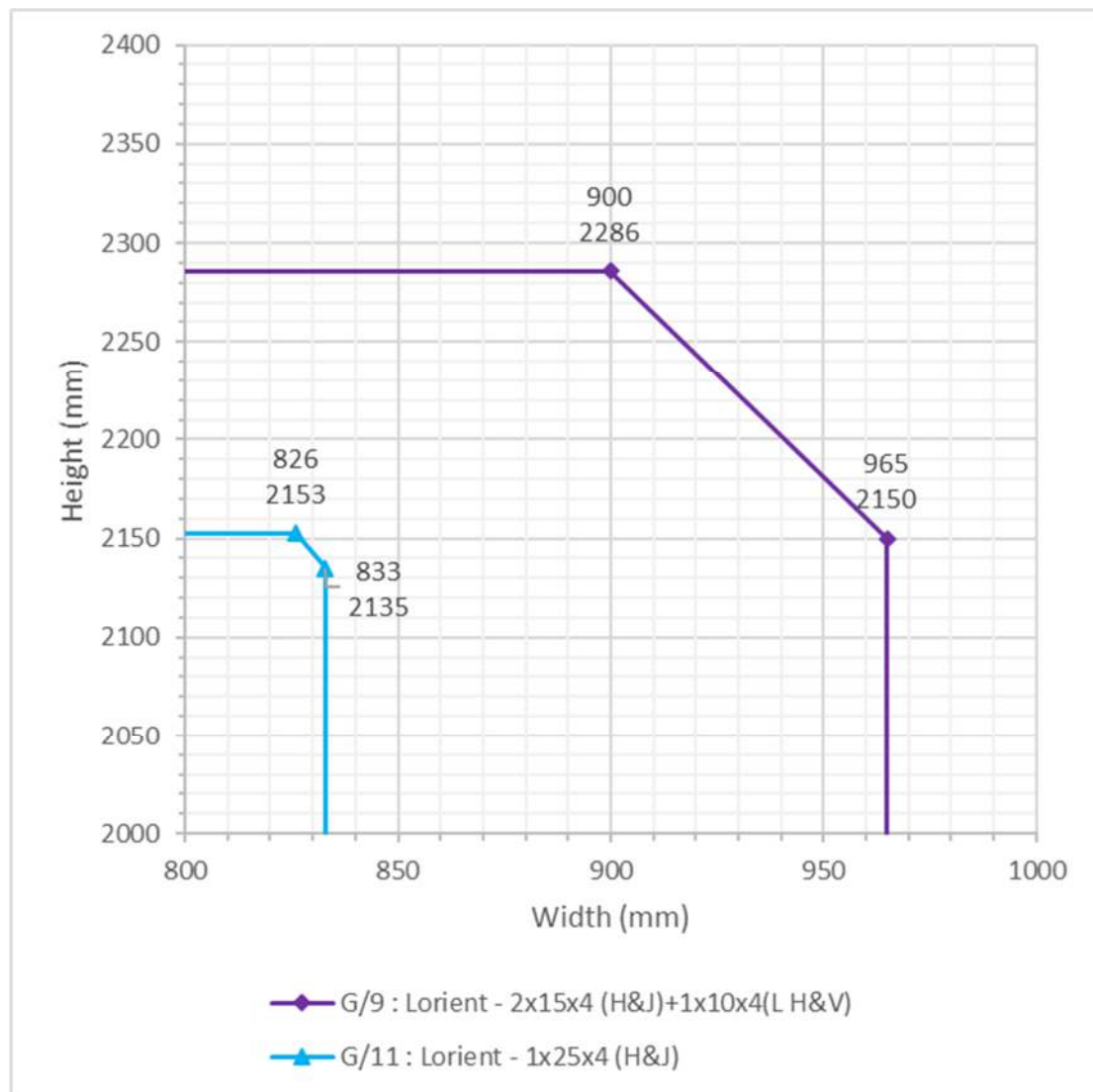

Lorient Intumescent Specification for ULSADD Leaf 1 with Frame 1		
Intumescent Spec. Reference (Test Reference)	Make / Type	Location & Size
G/9 (RF98051)	Lorient LP1504	<p>Head & Jambs: 2no 15x4. Fitted in frame reveal and 8mm apart</p> <p>Leaf head and vertical hanging edges: 1no 10x4. Fitted centrally in leaf edges</p> <p>Meeting Edge: 2no 15x4, fitted centrally and 8mm apart in one leaf 1no 10x4, fitted centrally in other leaf</p>

Lorient Intumescent Specification for ULSADD Leaf 1 with Frame 1		
Intumescent Spec. Reference (Test Reference)	Make / Type	Location & Size
G/11 (RF03041A)	LP2504 Type 617 ¹	Head & Jambs: 1no 25x4. Fitted in frame reveal Meeting Edge: 1no 25x4, fitted centrally in one leaf

Note

1. Test reference RF03041A was carried out using Lorient Palusol intumescent seals. Comparisons have been made between the performance of test references RF0006A and RF06005A with integrity performances of 60 and 75 minutes respectively (both ULSASD using 2no 15x4mm Palusol intumescent seals fitted in the frame reveals) against test reference RF07128A with integrity performance of 72 minutes (ULSASD using 2no 15x4mm Lorient 617 type intumescent seals fitted in the frame reveals). There were differences in the tested leaf size, with RF07128A being a larger tested leaf, which would be considered to be a more onerous test. It is therefore the opinion of Warringtonfire that for the designs considered herein, when the tested intumescent was Lorient Palusol that Lorient Type 617 can be used at the same intumescent sizes. The above table states the permitted intumescent type.

Leaf size envelopes for ULSADD using Leaf 1 and Frame 1 with Pyroplex seals

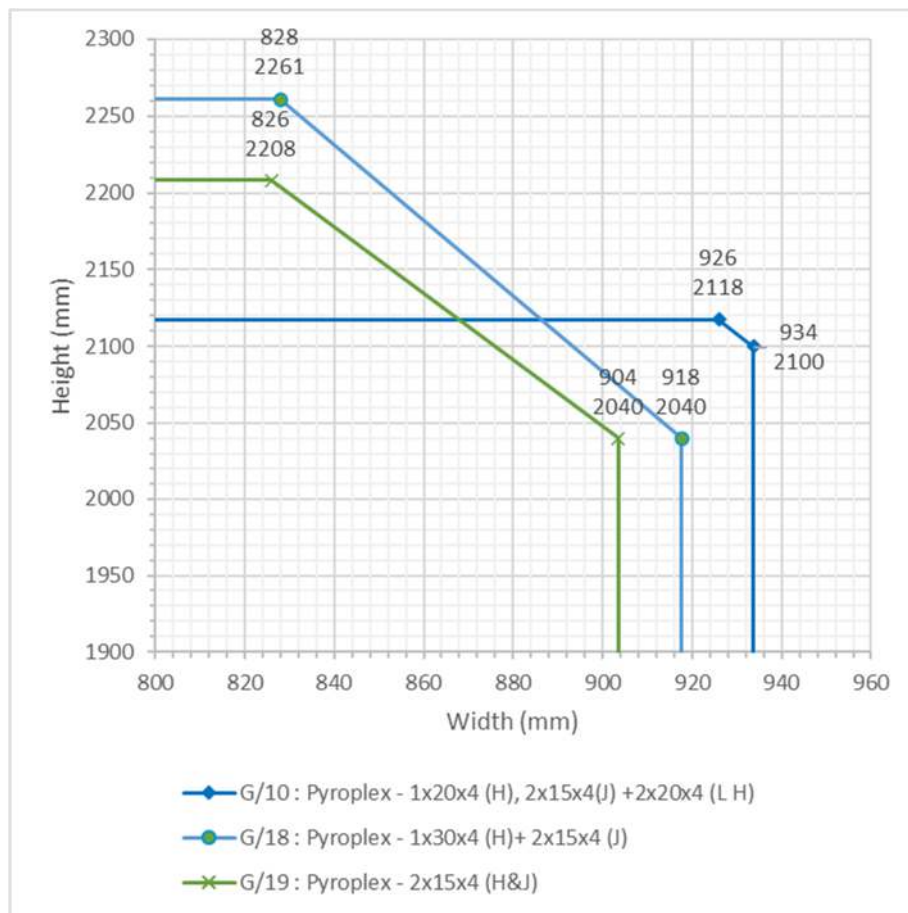

Pyroplex Intumescent Specification for ULSADD Leaf 1 with Frame 1		
Intumescent Spec. Reference (Test Reference)	Make / Type	Location & Size
G/10 (WF504390)	Pyroplex 8600	Head: 1no 20x4. Fitted in frame reveal
	8700 / 30155	Jamb: 2no 15x4. Fitted in frame reveal and 10mm apart
	30156	Leaf Head: 2no 20x4. Fitted in leaf head and 8mm apart
	8700 / 30155	Meeting Edge: 2no 15x4, fitted centrally and 10mm apart in one leaf

Pyroplex Intumescent Specification for Ulsadd Leaf 1 with Frame 1		
Intumescent Spec. Reference (Test Reference)	Make / Type	Location & Size
G/18 (RF02018 RevA)	Pyroplex 3009412 8721 8721	Head: 1no 30x4. Fitted in frame head reveal Jamb: 2no 15x4. Fitted in frame jamb reveal centrally and 10mm apart Meeting Edge: 2no 15x4, fitted centrally and 10mm apart in one leaf
G/19 (CFR2103161)	Pyroplex 8700 / 30155	Head & Jamb: 2no 15x4. Fitted in frame reveal and 10mm apart Meeting edge junction: Option 1) With equal rebated meeting edge: Meeting Edge: 2no 15x4. 1no fitted centrally in unrebated section of each leaf meeting edge Option 2) With flat lipping meeting edge: Meeting Edge: 2no 15x4, fitted centrally and 10mm apart in one leaf

Leaf size envelopes for ULSADD using Leaf 1 and Frame 1 with STS seals.

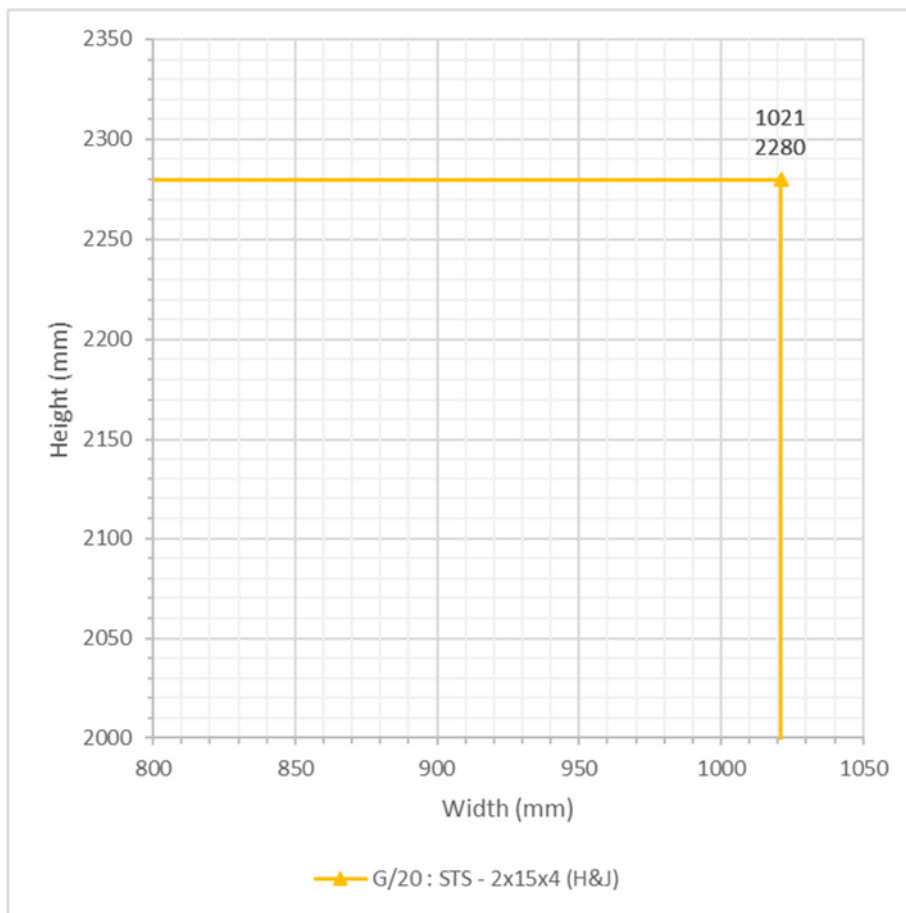

STS Intumescent Specification for ULSADD Leaf 1 with Frame 1		
Intumescent Spec. Reference (Test Reference)	Make / Type	Location & Size
G/20 (BMT/FEP/F15163)	STS ST1504FO	Head & Jamb: 2no 15x4. Fitted in frame reveal and 10mm apart Meeting Edge: 2no 15x4, fitted centrally and 10mm apart in one leaf

4.5.13.2 Leaf 1 + Frame 2 Doorset

Leaf size envelopes for ULSADD using Leaf 1 and Frame 2 using Halspan and Lorient seals.

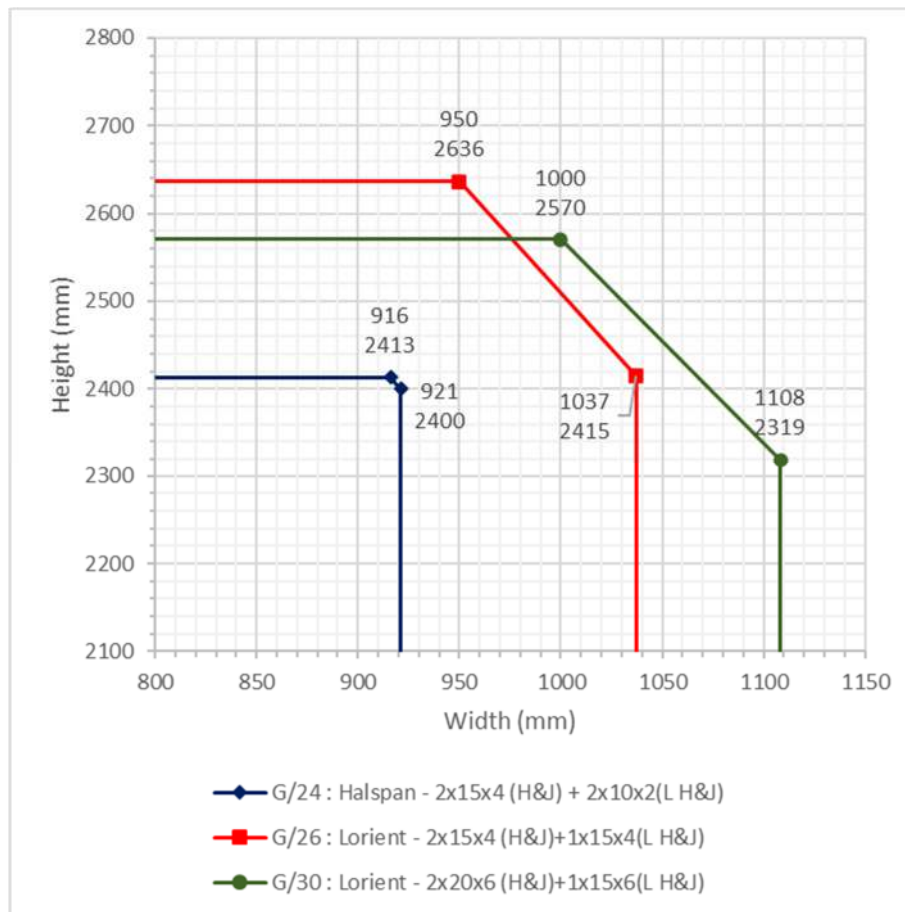

Halspan and Lorient Intumescent Specification for ULSADD Leaf 1 with Frame 2		
Intumescent Spec. Reference (Test Reference)	Make / Type	Location & Size
G/24 (CFR1809241)	Halspan SLS	Head & Jamb: 2no 15x4. Fitted in frame reveal, centrally and 10mm apart
	Halspan MAP	Leaf head and vertical hanging edges: 2no layers 10x2. Fitted in a 10x4 rebate centrally in leaf edges
	Halspan SLS	Leaf meeting edges: 2no 15x4. Fitted in frame reveal, centrally and 10mm apart in one leaf meeting edge
	Halspan MAP	2no layers 10x2. Fitted in a 10x4 rebate centrally in other leaf meeting edge

Halspan and Lorient Intumescent Specification for ULSADD Leaf 1 with Frame 2		
Intumescent Spec. Reference (Test Reference)	Make / Type	Location & Size
G/26 (FRR-2009/2351)	Lorient LP1504	Head & Jambs: 2no 15x4. Fitted in frame reveal, centrally and 10mm apart Leaf head and vertical hanging edges: 1no 15x4. Fitted centrally in leaf edges Leaf meeting edges: 2no 15x4. Fitted centrally and 10mm apart in one leaf meeting edge 1no 15x4. Fitted centrally in other leaf meeting edge
G/30 (FRR-2102/4628A)	Lorient LP2006 Lorient LP1506 Lorient LP2006 Lorient LP1506	Head: 2no 20x6. Fitted in frame head reveal, centrally and 15mm apart Jambs: 2no 20x6. Fitted in frame jamb reveal, centrally and 6mm apart Leaf head and vertical hanging edges: 1no 15x6. Fitted centrally in leaf edges Leaf meeting edges: 2no 20x6. Fitted centrally and 6mm apart in one leaf meeting edge 1no 15x6. Fitted centrally in other leaf meeting edge

4.5.13.3 Leaf 1 + Frame 3 Doorset

Leaf size envelopes for ULSADD using Leaf 1 and Frame 3 using Halspan seals.

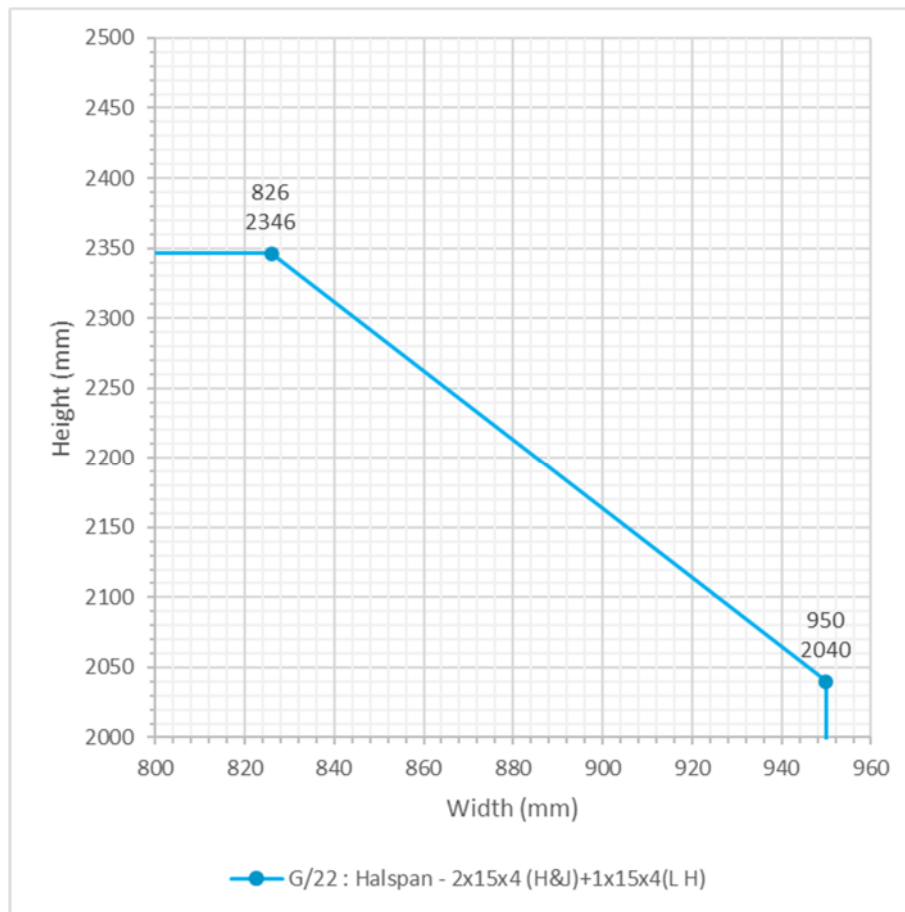

Halspan Intumescent Specification for ULSADD Leaf 1 with Frame 3		
Intumescent Spec. Reference (Test Reference)	Make / Type	Location & Size
G/22 (CFR2211141 LH)	Halspan SLS	Head & Jamb: 2no 15x4. Fitted in frame reveal, centrally and 10mm apart Leaf heads: 1no 15x4. Fitted centrally in leaf edges Meeting Edge: 2no 15x4. Fitted centrally and 10mm apart in one leaf. 1no 15x4. Fitted centrally in other leaf.

Leaf size envelopes for ULSADD using Leaf 1 and Frame 3 using Lorient seals.

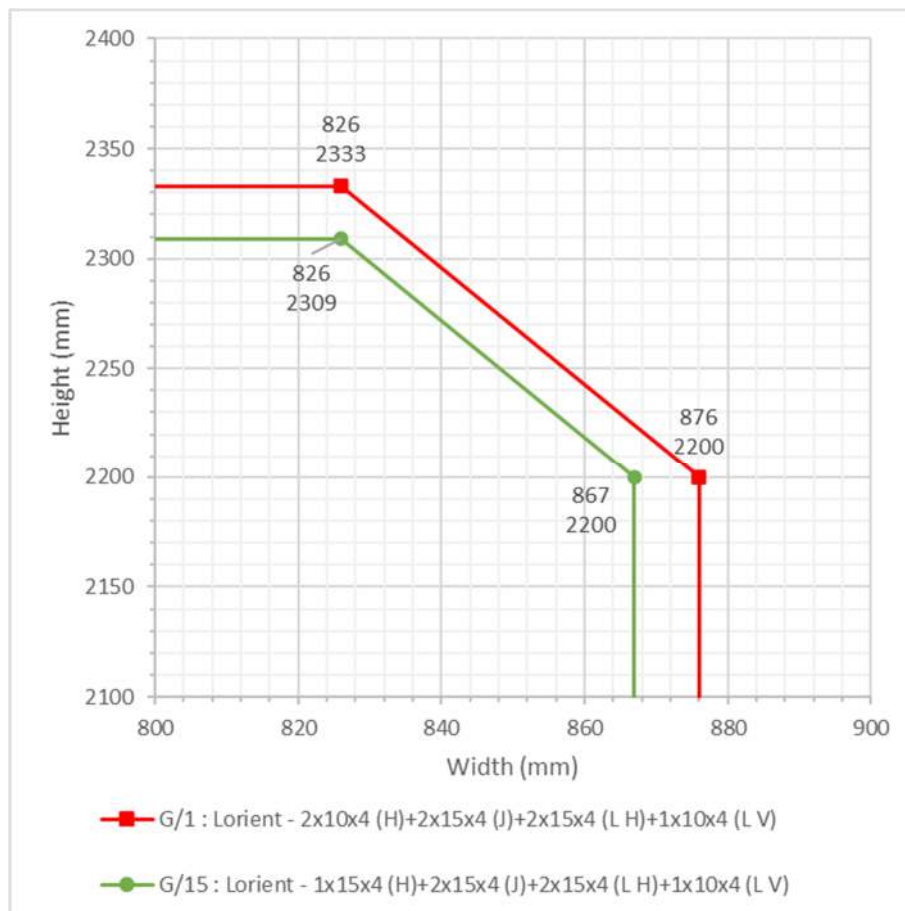

Lorient Intumescent Specification for ULSADD Leaf 1 with Frame 3		
Intumescent Spec. Reference (Test Reference)	Make / Type	Location & Size
G/1 (WF509420)	Lorient LP1004	Head: 2no 10x4. Fitted in frame head reveal, centrally and 25mm apart
	Lorient LP1504	Jamb: 2no 15x4. Fitted in frame jamb reveal, centrally and 10mm apart
	Lorient LP1504	Leaf heads: 2no 15x4. Fitted in leaf heads, centrally and 10mm apart
	Lorient LP1004	Leaf hanging edges: 1no 10x4. Fitted centrally in leaf edges
	Lorient LP1504	Meeting Edge: 2no 15x4. Fitted centrally and 10mm apart in one leaf.
	Lorient LP1004	1no 15x4. Fitted centrally in other leaf.

Lorient Intumescent Specification for ULSADD Leaf 1 with Frame 3		
Intumescent Spec. Reference (Test Reference)	Make / Type	Location & Size
G/15 (WF509421)	Lorient LP1504	Head: 1no 15x4. Fitted in frame head reveal, centrally
	LP1504	Jamb: 2no 15x4. Fitted in frame jamb reveal, centrally and 10mm apart
	LP1504	Leaf heads: 2no 15x4. Fitted in leaf heads, centrally and 10mm apart
	LP1004	Leaf hanging edges: 1no 10x4. Fitted centrally in leaf edges
	LP1504	Meeting Edge: 2no 15x4. Fitted centrally and 10mm apart in one leaf.
	LP1004	1no 15x4. Fitted centrally in other leaf.

4.5.13.4 Leaf 1 + Frame 4 or 5 Doorset

For leaf size envelopes for ULSADD using Leaf 1 and Frame 4 or 5 using Halspan seals see intumescent specification G/22 within section 4.5.13.3.

4.5.13.5 Leaf 1 + Frame 7 Doorset

For leaf size envelopes for ULSADD using Leaf 1 and Frame 7 see intumescent specifications G/8, G/9, G/10, G/19 & G/20 within section 4.5.13.1.

4.5.14 DADD Configuration: Leaf Sizes & Intumescent Specification

4.5.14.1 Leaf 1 + Frame 1 Doorset

For leaf size envelopes for DADD using Leaf 1 and Frame 1 see intumescent specifications G/1, G/9, G/10, G/15, G/18, G/19 and G/30 within sections 4.5.13.1 and 4.5.13.2 and 4.5.13.3.

4.5.14.2 Leaf 1 + Frame 2 Doorset

For leaf size envelopes for DADD using Leaf 1 and Frame 2 see intumescent specification G/26 and G/30 within section 4.5.13.2.

4.5.14.3 Leaf 1 + Frame 3 Doorset

For leaf size envelopes for DADD using Leaf 1 and Frame 3 see intumescent specifications G/1 & G/15 within section 4.5.13.3.

4.5.14.4 Leaf 1 + Frame 4, 5, or 7 Doorset

Not Permitted.

4.5.15 LSADD+OP Configuration: Leaf Sizes & Intumescent Specification

4.5.15.1 Leaf 1 + Frame 1 Doorset

Leaf size envelopes for LSADD+OP using Leaf 1 and Frame 1 with Pyroplex seals

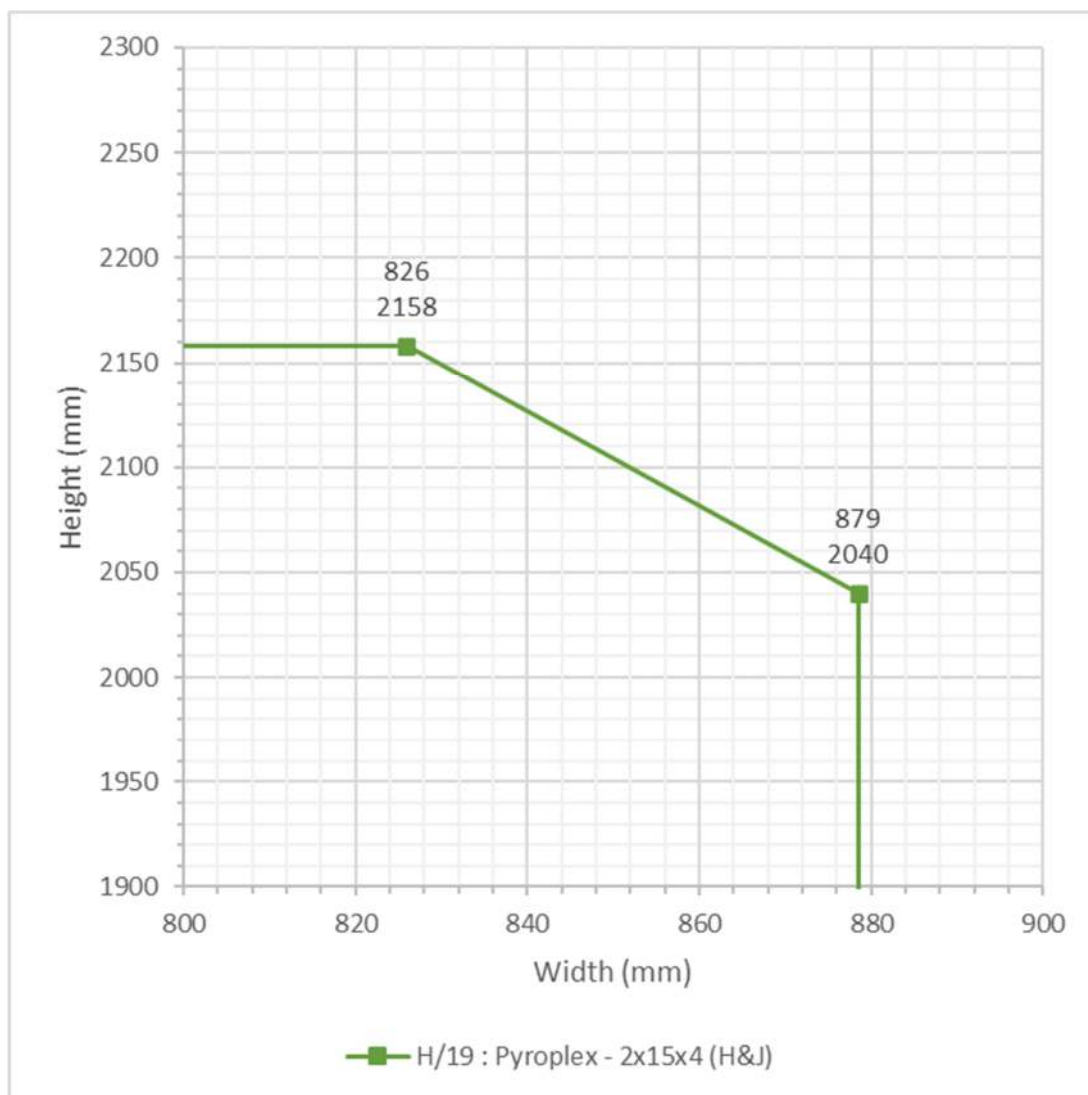

Pyroplex Intumescent Specification for LSADD+OP Leaf 1 with Frame 1		
Intumescent Spec. Reference (Test Reference)	Make / Type	Location & Size
H/19 (CFR2103161)	Pyroplex 8700 / 30155	<p>Head & Jambs: 2no 15x4. Fitted in frame reveal and 10mm apart</p> <p>Meeting edge junction: Option 1) With equal rebated meeting edge: Meeting Edge: 2no 15x4. 1no fitted centrally in unrebated section of each leaf meeting edge</p> <p>Option 2) With flat lipping meeting edge: Meeting Edge: 2no 15x4, fitted centrally and 10mm apart in one leaf</p> <p>Leaf head to overpanel junction: Option a) With equal rebated flush overpanel: Overpanel and leaf head: 1no 15x4. Fitted centrally in unrebated section of overpanel bottom edge 1no 15x4. Fitted centrally in unrebated section of leaf top edge</p> <p>Option b) With flat lipping flush overpanel: Overpanel and leaf head: 2no 15x4: Fitted 10mm apart and centrally to overpanel bottom edge.</p>

Leaf size envelopes for LSADD+OP using Leaf 1 and Frame 1 with Lorient seals

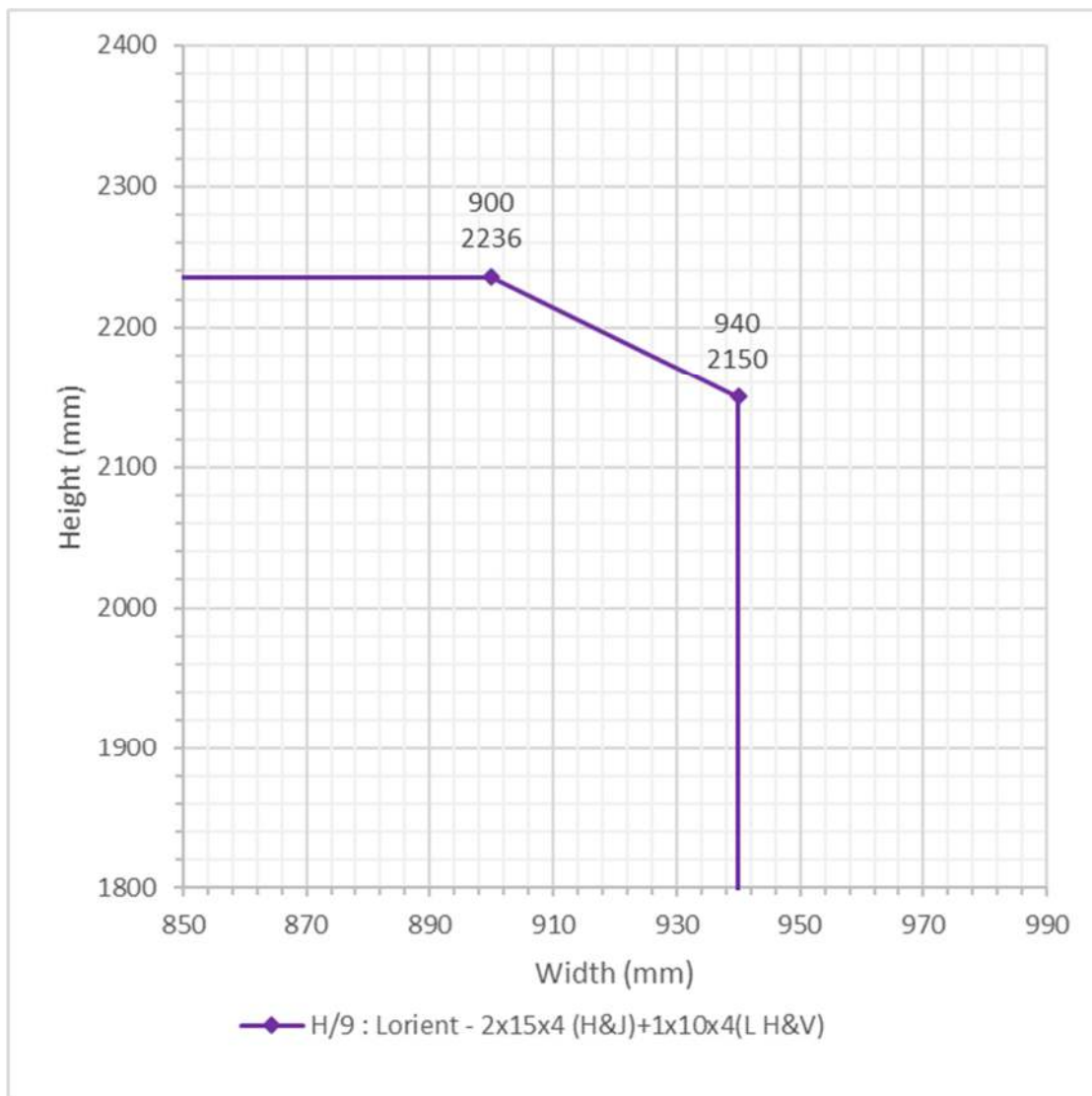

Lorient Intumescent Specification for LSADD+OP Leaf 1 with Frame 1		
Intumescent Spec. Reference (Test Reference)	Make / Type	Location & Size
H/9 (RF98051)	Lorient LP1504 / LP1004	<p>Head & Jambs: 2no 15x4. Fitted in frame reveal and 8mm apart</p> <p>Vertical hanging edges: 1no 10x4. Fitted centrally in leaf edges</p> <p>Meeting Edge: 2no 15x4, fitted centrally and 8mm apart in one leaf 1no 10x4, fitted centrally in other leaf</p> <p>Leaf head to overpanel junction: Option a) With equal rebated flush overpanel: Overpanel and leaf head: 1no 15x4. Fitted centrally in rebate of overpanel bottom edge 1no 15x4. Fitted centrally in upstand of overpanel bottom edge 1no 10x4. Fitted in the corner of the rebate of leaf top edge</p> <p>Option b) With flat lipping flush overpanel: Overpanel and leaf head: 2no 15x4: Fitted 10mm apart and centrally to overpanel bottom edge. 1no 10x4 Fitted centrally to the leaf top edge</p>

4.5.15.2 Leaf 1 + Frame 2, 3, 4, 5, or 7 Doorset

Not Permitted.

4.5.16 ULSADD+OP Configuration: Leaf Sizes & Intumescent Specification

4.5.16.1 Leaf 1 + Frame 1 Doorset

Leaf size envelopes for ULSADD+OP using Leaf 1 and Frame 1 with Pyroplex seals

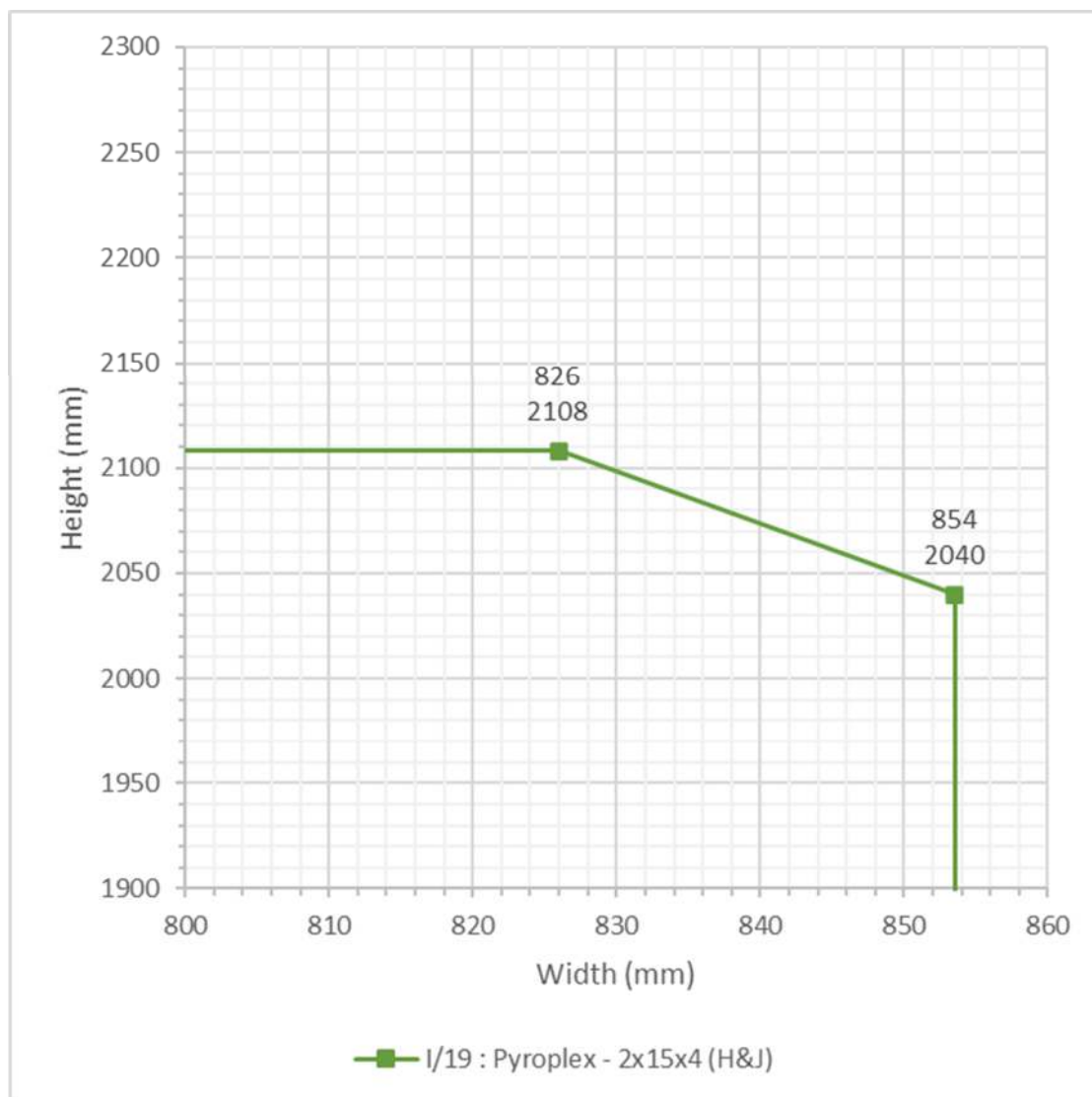

Pyroplex Intumescent Specification for ULSADD+OP Leaf 1 with Frame 1		
Intumescent Spec. Reference (Test Reference)	Make / Type	Location & Size
I/19 (CFR2103161)	Pyroplex 8700 / 30155	<p>Head & Jambs: 2no 15x4. Fitted in frame reveal and 10mm apart</p> <p>Meeting edge junction: Option 1) With equal rebated meeting edge: Meeting Edge: 2no 15x4. 1no fitted centrally in upstand of each leaf meeting edge</p> <p>Option 2) With flat lipping meeting edge: Meeting Edge: 2no 15x4, fitted centrally and 10mm apart in one leaf</p> <p>Leaf head to overpanel junction: Option a) With equal rebated flush overpanel: Overpanel and leaf head: 1no 15x4. Fitted centrally in upstand of overpanel bottom edge 1no 15x4. Fitted centrally in upstand of leaf top edge</p> <p>Option b) With flat lipping flush overpanel: Overpanel and leaf head: 2no 15x4: Fitted 10mm apart and centrally to overpanel bottom edge.</p>

Leaf size envelopes for LSADD+OP using Leaf 1 and Frame 1 with Lorient seals

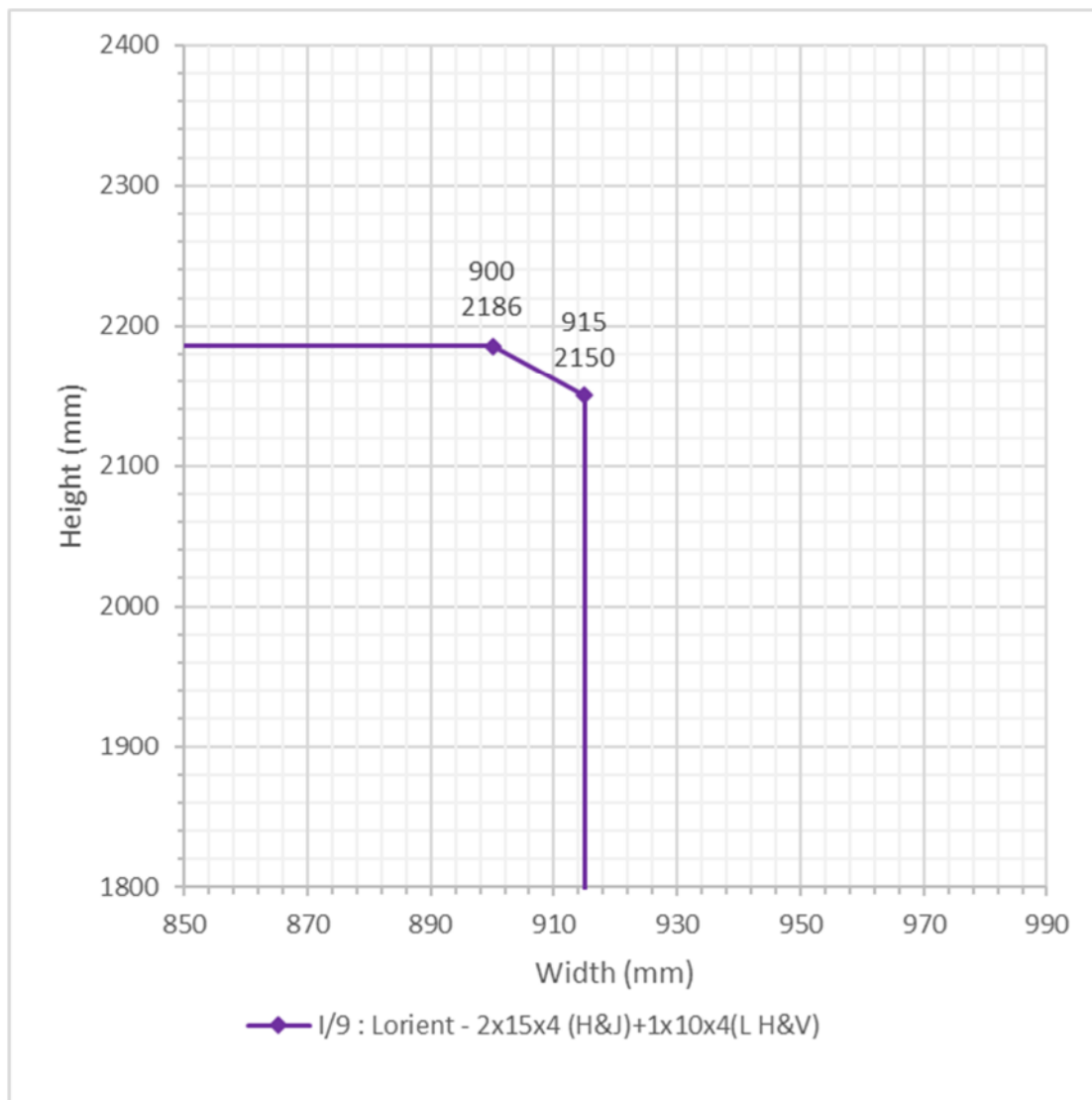

Lorient Intumescent Specification for ULSADD+OP Leaf 1 with Frame 1		
Intumescent Spec. Reference (Test Reference)	Make / Type	Location & Size
I/9 (RF98051)	Lorient LP1504 / LP1004	<p>Head & Jambs: 2no 15x4. Fitted in frame reveal and 8mm apart</p> <p>Vertical hanging edges: 1no 10x4. Fitted centrally in leaf edges</p> <p>Meeting Edge: 2no 15x4, fitted centrally and 8mm apart in one leaf 1no 10x4, fitted centrally in other leaf</p> <p>Leaf head to overpanel junction: Option a) With equal rebated flush overpanel: Overpanel and leaf head: 1no 15x4. Fitted centrally in rebate of overpanel bottom edge 1no 15x4. Fitted centrally in upstand of overpanel bottom edge 1no 10x4. Fitted in the corner of the rebate of leaf top edge</p> <p>Option b) With flat lipping flush overpanel: Overpanel and leaf head: 2no 15x4: Fitted 10mm apart and centrally to overpanel bottom edge. 1no 10x4 Fitted centrally to the leaf top edge</p>

4.5.16.2 Leaf 1 + Frame 2, 3, 4, 5, or 7 Doorset

Not Permitted.

5 General Description of Leaf Construction

5.1 Leaf Core Construction

The door leaf option detailed below is approved by this assessment.

5.1.1 Leaf Type 1 – Prima 60 – 54mm thick

The basic tested construction of this door leaf design comprises the following:

Element	Material	Dimensions (mm)	Minimum Density (kg/m ³)
Core	Halspan Prima 3 layer solid core particleboard	54 (t)	630±10%

The leaf must be lipped as specified in section 5.3.

The minimum leaf thickness after calibration is 53mm (i.e. a maximum of 0.5mm from both sides).

The minimum leaf thickness after finishes applied is 54mm.

5.2 Leaf Size Adjustment During Manufacturing

Door leaves may be altered as follows prior to the machining for hardware.

Pre-Machining Leaf Size Adjustment Specification	
Element	Reduction
Leaf	The size of the leaf may be reduced in height or width without restriction for manufacturing purposes, providing the finished leaf is lipped in accordance with section 5.3.
Timber Lipping	The timber lipping thickness can be reduced after it has been glued in place, providing it is not reduced below the minimum stated in section 5.3.

5.3 Lipping

The following sections detail the permitted lippings for the Prima 60 doorset design covered herein.

5.3.1 Hardwood Timber Lipping (Excluding Beech)

The testing documented in section 3 has generally been undertaken using 3-10 mm thick flat lippings applied to either vertical edges; vertical and top edges; or all edges using hardwood of various species at varying densities. A number of different adhesives have also been used to bond the lippings to the core.

Rounded sapele lippings to the hanging edges of maximum 10mm thick radiused to minimum 6mm x 54mm were tested successfully in test reference RF02018 Rev A.

Equal rebated sapele lippings located at meeting edges and/or the top edge (to match with equal rebated flush overpanels) have been successfully tested test references CFR2103161, CFR1802131 and RF98051. CFR1802131 has additionally been used to support the dimensions of flat lippings up to 18mm.

On the above basis, Prima 60 door blanks (leaf 1) must be lipped with the following specification. This applies to door leaves, and flush overpanels.

Timber Lipping Specification for Prima 60 door blanks		
Material	Size (mm)	Min Density (kg/m ³)
Hardwood (not Beech species) <i>fagus</i>	Flat = 3 - 18 thick	640
	Flat "T Section" = 6 – 10 thick (Exposed) with a tongue centrally into the core material with maximum dimensions of 38mm wide x 15mm deep, the tongue may be integral to the exposed element or separate.	
	Rounded = 8 – 20 thick with a radius matching the distance between leaf edge and floor pivot (see sections 7.1.2 & 7.2.2)	
	Rebated = 15 – 25mm thick with an equal rebate of 12 – 13mm deep	

Notes:

- All lippings are to be the same thickness as the door leaf either prior to the application of decorative facing materials or once they have been applied.
- Overpanels separated from the leaf heads with a transom do not need to be lipped.
- Overpanels flush with the leaf heads must be lipped on their bottom edge but may additionally be lipped on all edges if required, lippings to top three edges where applied must be Flat.
- Leaves to doorsets with flush overpanels must be lipped on the vertical edges and additionally at the top edge of the doors, they may additionally be lipped on the bottom edges if required.
- Single and double doorsets without flush overpanels only require lipping on the vertical edges but may be additionally lipped on the top and bottom edges if required.

6. Rebated lippings (to leaf head/ overpanel junction and/or meeting edge of double leaf doorsets) are only permitted when detailed as an option within the applicable intumescent specification in section 4.5. Where not specifically detailed the leaf lipping must be flat at the leaf head/ overpanel junction and/or meeting edge of double leaf doorsets.
7. Lippings can be bonded with UF, PU, PUR, PF, PVA or PVAc. These may be hand applied or may be applied using an edgebander. With either method it must be ensured that sufficient glue is applied to across the entire surface area between the 2No substrates being adhered to guarantee a robust bond. Other manufacturers guidance should be followed, for either installation application.
8. For flat lippings it is permitted to apply one of the following:
 - a. Maximum 3mm radius to the corners of the lippings at vertical edges to create edge profiling. (Based upon test reference WF504390).
 - b. Maximum of 3mm x 3mm chamfer applied to the corners of the lippings at vertical edges to create edge profiling.
 - c. Maximum 2mm wide x 5mm deep chamfer to the vertical leading edges of the leaves, if this would result in a conflict with intumescent positioning this option is not permitted.
9. For rounded lippings a minimum of 6mm thickness of lipping shall be measured at the face of the door leaf where the lipping is its minimum thickness. Rounded lippings are only permitted for use at hanging edges with a scalloped frame.
10. For doorsets which include a flush overpanel refer to section 5.8 for astragal requirements.

5.3.2 PVC and ABS Lipping

PVC lipping to all edges of the leaf has been successfully tested in test reference Chilt/RF08035. On the basis of this testing PVC and ABS lippings are suitable in the following applications only:

5.3.2.1 Directly to Core Material

Frame options: 1

Configurations & Intumescent Specification (Defined in Section 4.5):

LSASD: A/5, A/6, A/7 & A/23

ULSASD: B/7, B/8 & B/13

LSADD: F/23, alternatively F/2 or F/8 with an additional 15x4 SLS fitted centrally to the vertical edge of the secondary leaf.

ULSADD: G/8 or G/13 with an additional 15x4 SLS fitted centrally to the vertical edge of the secondary leaf.

Lipping Specification		
Material	Maximum Size (mm)	Min Density (kg/m ³)
PVC or ABS	2 thick	-

Notes:

- 1) PVC or ABS lippings can be fitted directly to all edges of the door leaf.
- 2) PVC or ABS lippings must be bonded with Hotmelt PUR or polychloroprene contact adhesive.

5.3.2.2 Applied to Flat Hardwood Lippings (Defined in 5.3.1)

Frame options: 1, 3, 4 & 5

Configurations: LSASD, ULSASD, LSADD, ULSADD

Intumescent Specification: As defined within section 4.5.

Lipping Specification		
Material	Maximum Size (mm)	Min Density (kg/m ³)
PVC or ABS	2 thick	-

Notes:

- 1) When applied the vertical edges of the door leaf must be lipped with Flat Hardwood lippings in accordance with section 5.3.1.
- 2) PVC or ABS lippings can be fitted directly to horizontal edges of the door leaf or optionally flat hardwood lippings in accordance with section 5.3.1.
- 3) PVC or ABS lippings must be bonded with Hotmelt PUR or polychloroprene contact adhesive.

5.3.3 Beech Species Timber Lipping

The single acting single and double leaf doorset testing documented in section 3 with Beech lippings has been undertaken using 3-8 mm thick flat lippings applied to either the vertical edges or all edges. PU or PUR adhesives have been used to bond the lippings to the core.

The double acting doorset testing documented in section 3 with Beech lippings has been undertaken using 6mm thick flat lippings to all edges except the hanging edges which used 10 – 20mm rounded lippings. PU or PVAC adhesives have been used to bond the lippings to the core.

Test reference FRR 2010/2942 also included an equal rebated meeting edge of 20mm thick.

On the above basis, Prima 60 door blanks must be lipped with the following specification.

Beech Species Specification for Prima 60 door blanks		
Material	Size (mm)	Min Density (kg/m ³)
Steamed Beech (<i>Fagus species</i>)	Flat = 3 – 8 thick	660
	Rounded = 10 – 20 thick (overall) with a radius matching the distance between leaf edge and floor pivot (see sections 7.1.2 & 7.2.2)	
	Rebated = 20 mm thick with an equal rebate of no more than 12mm deep	

Notes:

1. Beech lippings meeting the specification above are not permitted for use with flush overpanels, lippings meeting the specification given in section 5.3.1 must be used.
2. All lippings are to be the same thickness as the door leaf either prior to the application of decorative facing materials or once they have been applied.
3. Overpanels separated from the leaf heads with a transom do not need to be lipped.
4. Single and double doorsets without transomed overpanels only require lipping on the vertical edges but may be additionally lipped on the top and bottom edges if required.
5. Rebated lippings (to the meeting edge of double leaf doorsets) are only permitted when detailed as an option within the applicable intumescent specification in section 4.5. Where not specifically detailed the leaf lipping must be flat at the meeting edge of double leaf doorsets.
6. Beech Lippings can be bonded with PU, UF, PUR or PVAc. These may be hand applied or may be applied using an edgebander. With either method it must be ensured that sufficient glue is applied to across the entire surface area between the 2No substrates being adhered to guarantee a robust bond. Other manufacturers guidance should be followed, for either installation application.
7. For flat lippings it is permitted to apply one of the following:
 - a. Maximum 2mm radius to the corners of the lippings at vertical edges to create edge profiling.
 - b. Maximum of 2mm x 2mm chamfer applied to the corners of the lippings at vertical edges to create edge profiling.

- c. Maximum 2mm wide x 3mm deep chamfer to the vertical leading edges of the leaves, if this would result in a conflict with intumescent positioning this option is not permitted.
8. For rounded lippings a minimum of 6mm thickness of lipping shall be measured at the face of the door leaf where the lipping is its minimum thickness. Rounded lippings are only permitted for use at hanging edges with a scalloped frame.

5.3.4 Example Illustrations of Lipping Details

SINGLE ACTING DOORS - STILES

Standard Stile Option

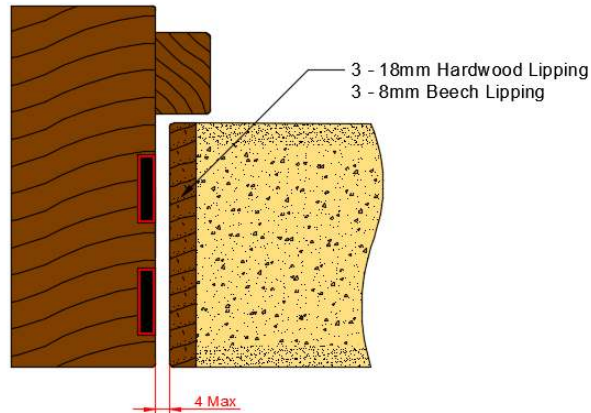

"T" Section Lipping

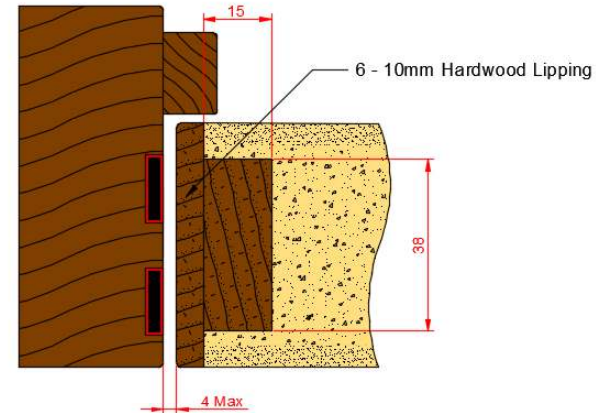

PVC Lipping Option 1

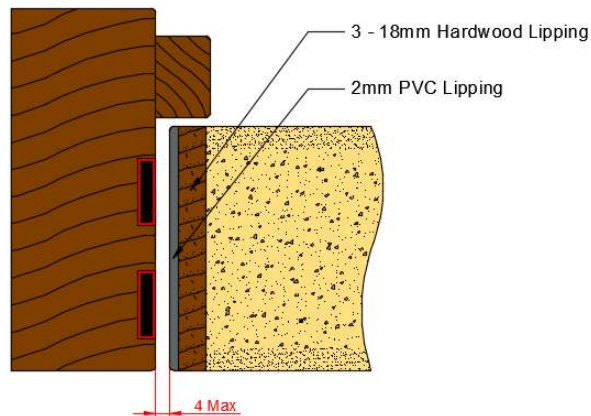

PVC Lipping Option 2

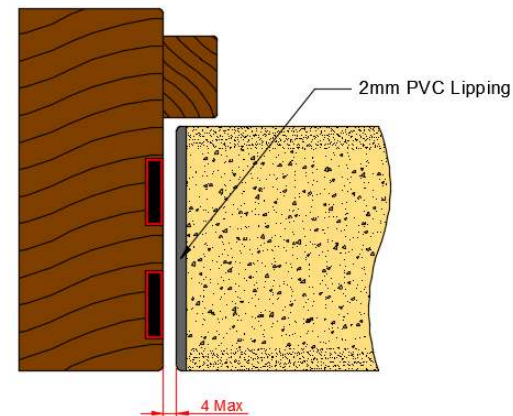

DOUBLE ACTING DOORS - STILES

Standard Stile Option (hanging edges only)

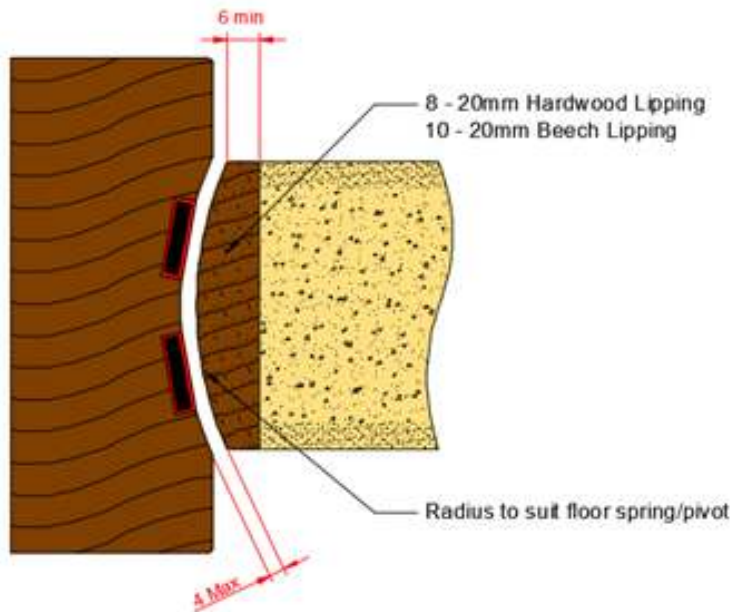

Radius Profile Option (closing edges only)

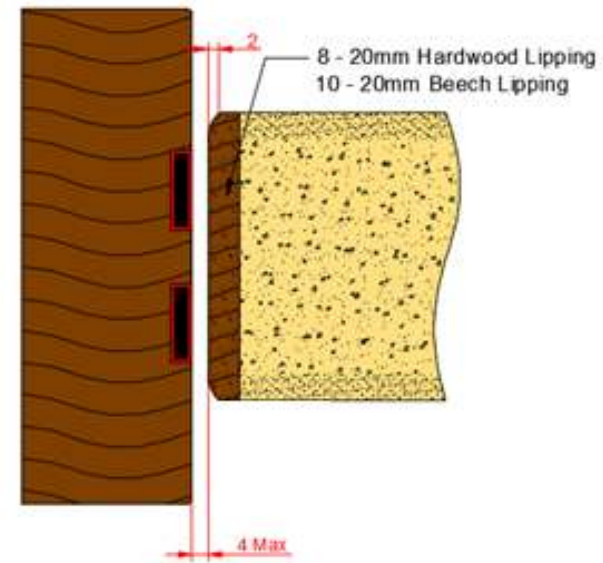

SINGLE ACTING DOORS - HEAD & THRESHOLD

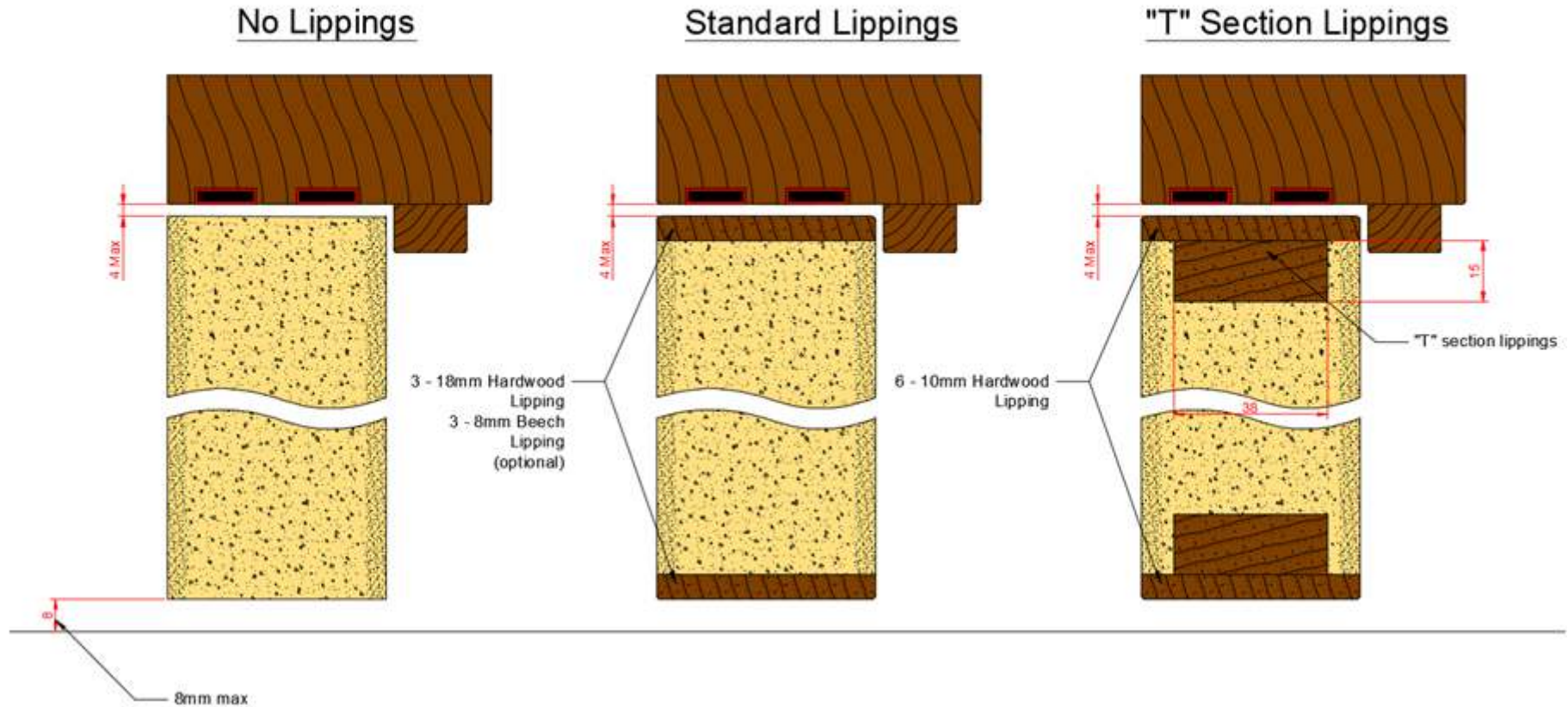

DOUBLE ACTING DOORS - HEAD & THRESHOLD

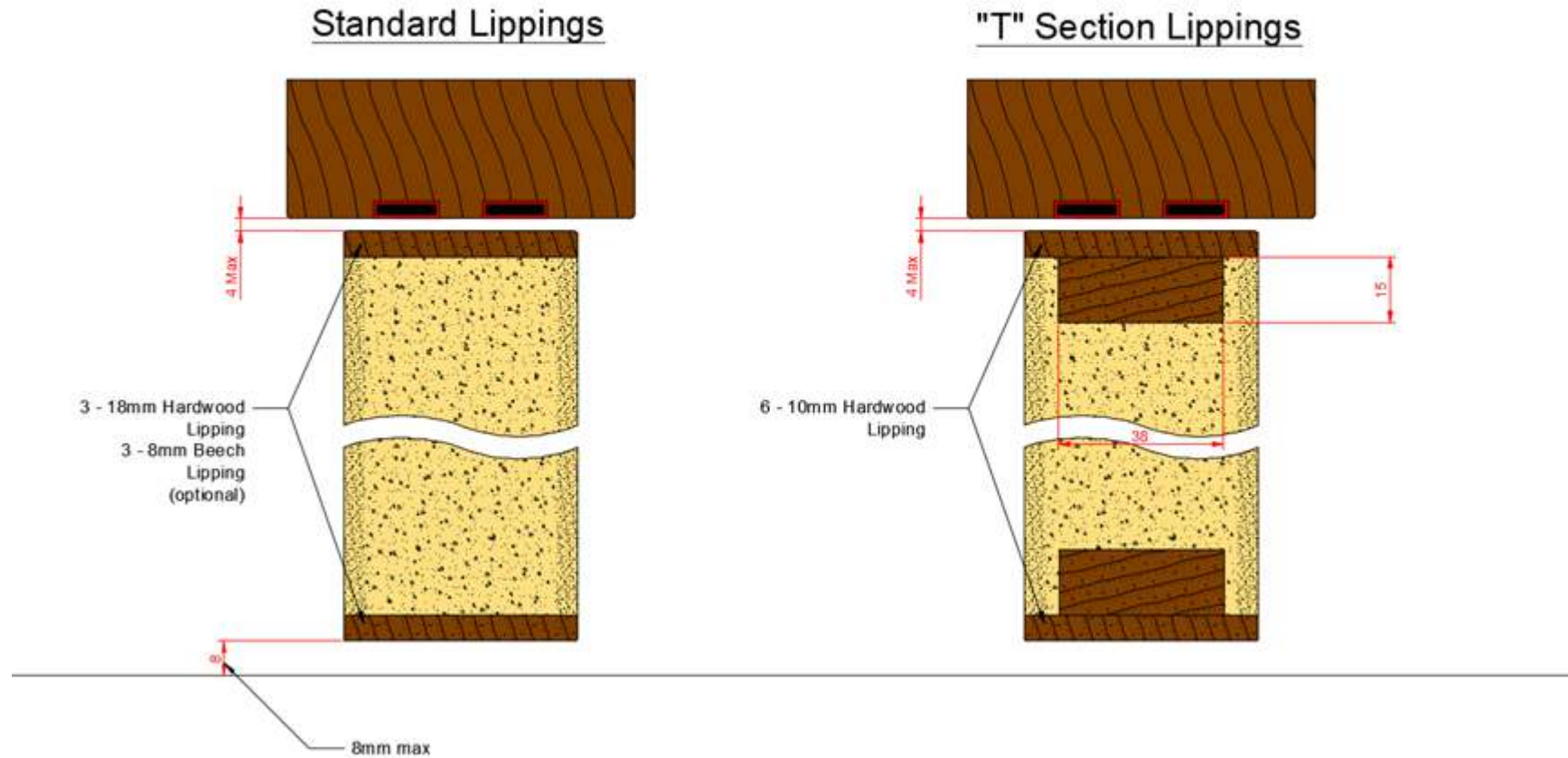

SINGLE ACTING DOORS - MEETING STILES

Flush Meeting Stiles

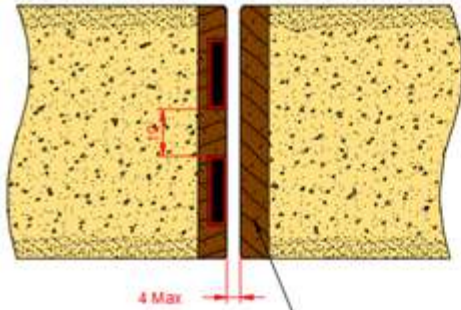

4 Max

3 - 18mm Hardwood Lipping
3 - 8mm Beech Lipping

Flush Meeting Stiles (with leading edge)

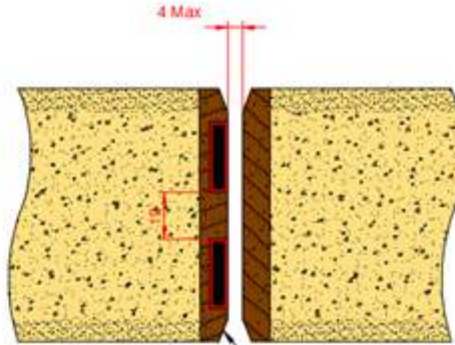

4 Max

Leading edge removing
no more than 2mm wide x
5mm deep material.
Can be applied to all vertical
leading edges if required.

Rebated Meeting Stiles

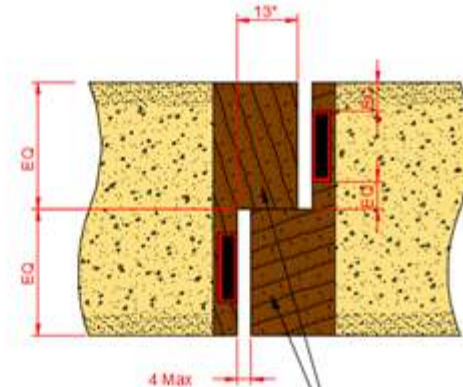

4 Max

15 - 25mm Hardwood
Lipping
20mm Beech Lipping

*Note: 12mm maximum rebate for Beech Lippings

DOUBLE ACTING DOORS - MEETING STILES

Flush Meeting Stiles

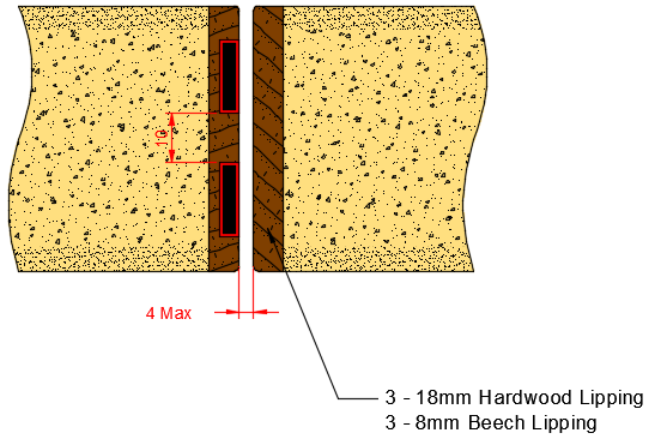

Flush Meeting Stiles (with leading edge)

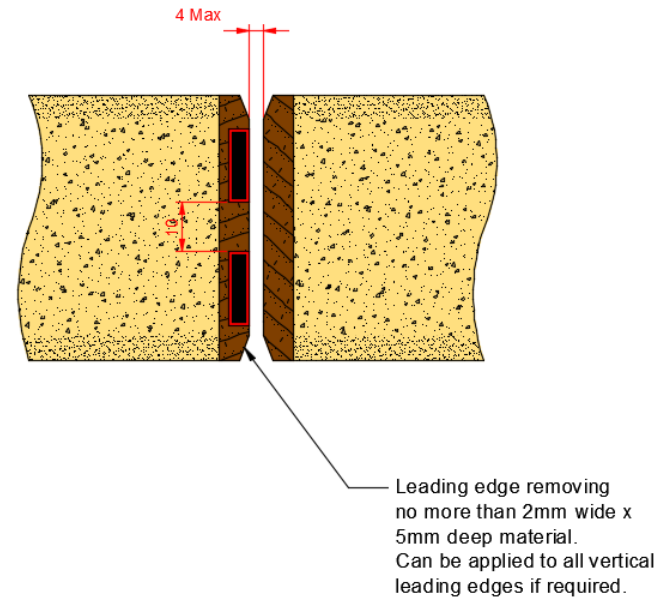

EDGE PROFILING DETAILS

Concealed

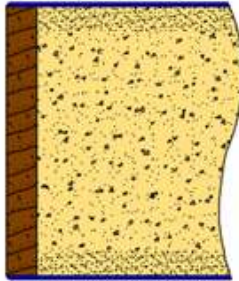

Semi-Concealed

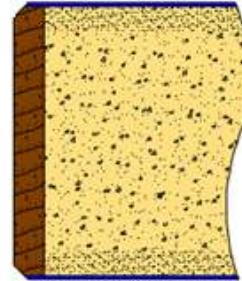

Exposed

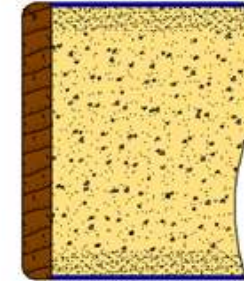

PVC

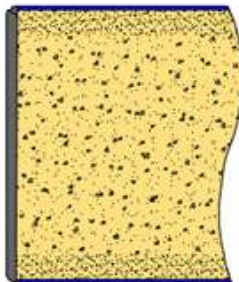

PVC on Hardwood

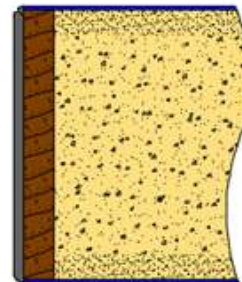

Scalloped

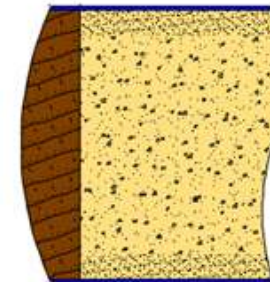

5.4 Edge Protectors

The use of Edge Protectors is not permitted within this Part 1 of the suite of FEA/F96103 field of applications for the Prima 60 product family.

5.5 Decorative & Protective Facings

Relatively thin leaf facing materials are deemed to be decorative and their application is not considered to be of detriment to the overall stability or performance of the doorset design. In fact, when applied as an additional component on top of the minimum facing material required by the door blank, they are likely to provide a small enhancement in performance as an additional barrier to fire spread, although, this is likely to be negligible.

The following additional facing materials are therefore permitted to the leaf for this door design since they would have limited influence under fire resistance test conditions.

Decorative & Protective Facing Specification	
Facing Material	Maximum Permitted Thickness (mm)
Paint ⁵	0.2
Timber veneers ³	2
Plastic laminates ³	2
PVC ³	2
Cellulosic and non-metallic foils and paper ³	0.4

Notes:

1. Metallic facings are not permitted except for push plates and kick plates
2. The door leaf thickness may be reduced on both sides by a maximum of 0.5mm for calibration purposes in order to accommodate the chosen finish. The minimum overall leaf thickness must remain at 54mm after finishing has been applied.
3. Materials may over sail lippings but must not return around leaf edges. Except:
 - o Timber veneers (with a minimum density of 640kg/m³) or HPL up to 0.8mm thick applied with UF adhesive, which may be applied to the leaf edges on top of timber based lippings defined in section 5.3.1 only.
4. For all options, materials must not conceal intumescent strips.
5. Intumescent paints are not permitted.
6. Decorative finishes listed above may be painted within the limits for paint finish, above.
7. The decorative facings are bonded using the decorative facing adhesives listed in the table in section 9.

5.6 Decorative Planted on Timber Mouldings

On the basis that decorative timber planted on mouldings would not be expected to have a negative effect on the burn through of the leaf, it is the opinion of Warringtonfire that decorative mouldings can be applied to the Prima 60 door leaf providing the following criteria is adhered to:-

The mouldings:

1. Are surface applied to the door
2. Are no higher than 30mm i.e. proud of the door
3. Are no wider than 50mm
4. Cover no more than 20% of the door leaf area
5. Are no closer than 80mm to the door leaf edge or apertures within the leaf.
6. Are bonded into position and small pins may be used up to 12mm penetration into the door core.
7. Are bonded using any glue which is suitable for bonding the lipping of the door.

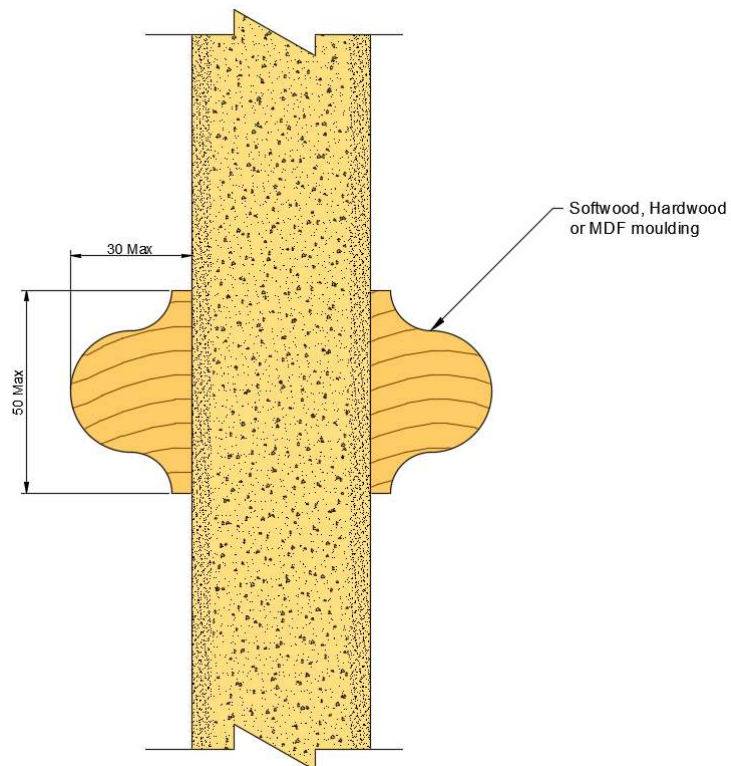

5.7 Feature Grooves

Feature grooves were included within test references CFR2209201, RF01056, FRR-2009/2351, FRR-2009/1221 and FRR-2102/4628A without being of detriment to the overall performance of the doorset. The doorsets they were included within achieved 68 (when the failures relating to the sidelight were isolated), 61, 71, 75 and 73 minutes respectively.

Both sides of the door leaves may be grooved to the following specifications, which also provide limitations on the application of the desired groove option.

Feature grooves cannot be located within 20mm of any mortice for hardware (i.e. any item which requires material to be removed from the door, including cableways).

Grooves may be applied to the leaf faces of glazed and unglazed doorsets. When applied to the face of a doorset including a glazed aperture the grooves shall not continue under the minimum dimensions provided for bolected glazing bead elements, however groove option A & B may run adjacent to them. This is supported by the evidence contained within RF01056 & FRR-2102/4628A which included grooving in this arrangement.

Where maximum leaf dimensions are given in the specifications for feature grooving below the guidance in section 4.5.5 must be followed.

Note for the following sections:

Grooves which are in the same linear plane but are not continuous are considered to count as one single groove.

5.7.1 Groove Option A

Groove Option A		
Element	Details	
Maximum groove size (mm)	5mm wide x 5mm deep	
Inserts	Not required. Full depth inserts are optionally permitted to provide a decorative detail if required. Inserts must be Hardwood (minimum density 640kg/m ³). The insert may be grooved when applied subject to restrictions given below.	
Adhesive	See Section 9 (Adhesives)	
Maximum number of grooves	8No. grooves divided between horizontal and vertical orientations as required.	
Proximity to door edges (mm)	Horizontal Grooves	No closer than 100mm to top or bottom edge of leaf. May extend full width
	Vertical Grooves	No closer than 100mm to vertical edge of leaf. May extend full height
Groove spacing (mm)	No insert applied or insert includes grooving	No closer than 80mm apart. Vertical and horizontal grooves may intersect each other.
	Full depth hardwood insert applied	No closer than 20mm apart. Vertical and horizontal grooves may intersect each other.
Orientation	Horizontal or Vertical	
Configurations	LSASD, ULSASD, DASD, LSADD, ULSADD, DADD	
Maximum Leaf size (mm)	No insert applied or insert includes grooving	2415mm x 950mm
	Full depth hardwood insert applied	No specified limit.
Minimum perimeter intumescent seal dimensions (mm)	All perimeter intumescent specifications given in section 4.5. subject to the permitted configurations given in the table above.	
Frame option	No insert applied or insert includes grooving	Frame 1 and 2 only
	Full depth hardwood insert applied	All frame options

5.7.2 Groove Option B

Groove Option B		
Element	Details	
Maximum groove size (mm)	15mm wide x 8mm deep	
Inserts	Required. Full depth inserts are required to be fitted within the groove. Inserts must be Hardwood (minimum density 640kg/m ³). The insert may be optionally grooved with a maximum of 4mm deep x 5mm wide groove of any shape required.	
Adhesive	See Section 9 (Adhesives)	
Maximum number of grooves	8No. grooves divided between horizontal and vertical orientations as required.	
Proximity to door edges (mm)	Horizontal Grooves	No closer than 150mm to top or bottom edge of leaf. May extend full width
	Vertical Grooves	No closer than 150mm to vertical edge of leaf. May extend full height
Groove spacing (mm)	No closer than 150mm apart. Vertical and horizontal grooves may intersect each other.	
Orientation	Horizontal or Vertical	
Configurations	LSASD, ULSASD, DASD, LSADD, ULSADD, DADD	
Maximum Leaf size (mm)	2415mm x 950mm	
Minimum perimeter intumescent seal dimensions (mm)	All perimeter intumescent specifications given in section 4.5. subject to the permitted configurations given in the table above.	
Frame option	Frame 1 and 2 only	

5.7.3 Groove Option C

Groove Option C		
Element	Details	
Maximum groove size (mm)	5mm wide x 2mm deep	
Inserts	Not required. Full depth inserts are optionally permitted to provide a decorative detail if required. Inserts may be Hardwood (minimum density 640kg/m ³), Brass or Aluminium. The insert may be grooved or profiled when applied but must not project greater than 1mm from the finished leaf face.	
Adhesive	See Section 9 (Adhesives)	
Maximum number of grooves	8No. grooves divided between horizontal and vertical orientations as required.	
Proximity to door edges (mm)	Horizontal Grooves	No closer than 100mm to top or bottom edge of leaf. May extend full width
	Vertical Grooves	No closer than 100mm to vertical edge of leaf. May extend full height
Groove spacing (mm)	No insert applied	No closer than 80mm apart. Vertical and horizontal grooves may intersect each other.
	Full depth hardwood insert applied	No closer than 20mm apart. Vertical and horizontal grooves may intersect each other.
Orientation	Horizontal or Vertical	
Configurations	LSASD, ULSASD, DASD, LSADD, ULSADD, DADD	
Maximum Leaf size (mm)	2415mm x 950mm	
Minimum perimeter intumescent seal dimensions (mm)	All perimeter intumescent specifications given in section 4.5. subject to the permitted configurations given in the table above.	
Frame option	Frame 1 and 2 only	

5.7.4 Groove Option D

Groove Option D	
Element	Details
Maximum groove size (mm)	45mm wide x 13mm deep
Inserts	Required. Full depth inserts are required to be fitted within the groove. Inserts must be Hardwood (minimum density 640kg/m ³). The insert may be optionally grooved with a maximum of 6mm deep x 30mm wide groove of any shape required.
Adhesive	See Section 9 (Adhesives)
Maximum number of grooves	10No. grooves divided between horizontal and vertical orientations as required.
Proximity to door edges (mm)	Horizontal Grooves No closer than 200mm to top or bottom edge of leaf. Must not extend full width and are not permitted closer than 150mm to the vertical edges of the leaf.
	Vertical Grooves No closer than 150mm to vertical edge of leaf. Must not extend full height and are not permitted closer than 200mm to the horizontal edges of the leaf.
Groove spacing (mm)	Adjacent parallel grooves no closer than 150mm apart. Vertical and horizontal grooves may intersect each other and terminate at corners to create rectangular mock panel designs.
Orientation	Horizontal or Vertical
Configurations	LSASD
Maximum Leaf size (mm)	2100mm x 926mm
Minimum perimeter intumescent seal dimensions (mm)	All perimeter intumescent specifications given in section 4.5. subject to the permitted configurations given in the table above.
Frame option	Frame 1

5.8 Astragal

The inclusion of timber astragals is permitted providing they meet the following specification:

- The astragal shall consist of the same material as the door frame with at least the same or greater density.
- The astragal shall be mechanically fixed using steel screws at no greater than 250mm centres, the screws shall penetrate into the substrate by at least 15mm and no greater than ½ the thickness of the substrate.
- The astragal shall measure 50mm wide x 18mm thick and shall be positioned centrally over the junction.

Other materials or dimensions of astragals are not permitted.

It has been considered possible to include the above specified astragal based on the fact that the effective rebate of the doorset design will remain unchanged. The addition of the astragal element will provide further protection at the perimeter gaps increasing the time at which failure modes may develop.

Astragals are:

- Optionally permitted at meeting edges of double leaf doorsets (without flush overpanels).
- See table below for Astragal requirements for doorsets with flush overpanels. When fitted at the flush overpanel junction, the astragal shall be fixed to the overpanel.

Astragals may only be fitted to one side of any individual doorset design.

When fitted to the meeting edges of double leaf doorsets, a door selector as defined within section 10.14 shall be fitted to the doorset to ensure functionality.

Astragal requirements for flush overpanel configurations		
Leaf Configuration	Edge condition	Astragal Requirement
LSASD+OP or ULSASD+OP	Flat lipping overpanel junction	Optional
	Rebated lipping overpanel junction	Not permitted
LSADD+OP or ULSADD+OP	Flat lipping overpanel junction with flat meeting edge	Required at overpanel junction.
	Rebated lipping overpanel junction with flat meeting edge	Optional at meeting edge
	Rebated lipping overpanel junction with rebated meeting edge	Not applicable

6 Glazing within the Leaf

6.1 General

The testing conducted on Halspan Prima 60 door designs has demonstrated that they are capable of tolerating glazed apertures, whilst providing a margin of over performance, this is supported by the summarised test evidence within section 3.

Glazing is therefore acceptable within the following parameters.

Apertures must not be less than 100mm from top and side edges and 200mm from the bottom edge. (Supported by RF13167).

Aperture shapes considered herein are rectilinear and as such are permitted unless alternative shapes are detailed within this document for specific glass or glazing systems. Based on the testing undertaken within RF98051 circular apertures may be utilised within the door leaf when covered by Certifire as defined within section 6.2 up to a maximum of 550mm diameter.

Apertures cannot be rotated (e.g. a square to be rotated to create a diamond effect) unless explicitly stated within this document for specific glass or glazing systems.

Double glazed units are only permitted where they have been directly tested and must be installed as tested and detailed in section 6.5 below.

6.1.1 Maximum Permitted Glazed Aperture Dimensions

The maximum total assessed aperture area for any individual door leaf based on the test evidence detailed within section 3 is as follows:

Maximum total permitted aperture within the Prima 60 door leaves (FRR-2102/4628)		
Maximum Height (mm)	Maximum Width (mm)	Maximum Area (m²)
2212	652	1.25

Multiple apertures are acceptable within the permitted total assessed aperture area, with a minimum dimension of 80mm of core between apertures. (As demonstrated in RF13167.)

Maximum glass thickness permitted is 27mm for single pane glazing.

Minimum glass thickness permitted is 5mm, as tested (WF385622) and may not be reduced.

The subsequent sections within this report detail the permitted glass and glazing systems with their associated size ranges permitted within the Prima 60 doorset design.

The maximum glazed areas given in each subsection supersede those given above and must be adhered to. However, the dimensional restrictions given above shall not be exceeded under any circumstance.

It is possible to include glass within the door leaf at smaller dimensions than given for any particular glass type or glazing system.

6.2 Certifire Single Pane Glass and Glazing System Options

Alternative glass and glazing systems with a Certifire certificate – valid at the date of manufacture of the doorset which has been written in accordance with Warringtonfire Testing & Certification Ltd, Technical Schedule TS25 - may be used to glaze the Prima 60 door design, subject to the following.

- The minimum thickness of glass permitted for alternative glass types is 5mm.
- The maximum thickness of glass permitted for alternative glass types is 25mm.
- Where a Certifire certificate is utilised to justify glazing the doorset, the full requirements given within that certificate for the glass and glazing system specified must be complied with.
- Parameters in section 6.1 above must take precedence over those in the supporting Certifire certificate, i.e. the glazed area, maximum height and width permitted in section 6.1 above may not be increased on the basis of the area, height and width permitted within the Certifire certificate. If the area, height and width in the proposed Certifire certificate is smaller than that in section 6.1, the smaller dimension will take precedence for the proposed glass or glazing system.
- The general requirements within the proposed Certifire certificate are still applicable, a specific reference to a door leaf construction similar to that assessed herein must be included – including leaf thickness.
- Where the Certifire certificate requires a timber aperture liner, these must always be fitted.
- Bead fixings – The required pin or screw specification as given in the supporting Certifire certificate must be used, alternatives fixing details are not permitted.

6.3 Single Pane Glass and Glazing Systems (Timber Beading)

The tested and assessed glass and glazing system(s) combinations, detailed within the table below may be used, subject to the limitations and scope detailed in section 6.1 above.

The table below specifies the maximum assessed height, width and area of glazing for each permitted glass type and glazing system.

The numerical figures in the main body of the table are the maximum height, width (m) & area of glass (in m²) that is considered acceptable for an individual glazed aperture, based upon the specific system. Where a '-' is applied the glass type and glazing system has not been considered compatible.

Halspan Glazing Systems

Glass & Glazing System Specification		Maximum Assessed Area (m ²), Height & Width (m)						
Glass Type Manufacturer	Thickness	System & Manufacturer →	1	2	3	4	5	
			Halspan 60 Glazing Mastic SLS-GLZ-102 3 thick & Halspan 60 Glazing Liner SLS-GLZ-102 54x2 Halspan	Halspan Glazing Tape SLS-GLZ-112 20x5 Liner SLS-GLZ-113 36x2 Halspan	Halspan Glazing Tape SLS-GLZ-112 20x5 Liner SLS-GLZ-113 47x2 Halspan	Halspan Glazing Tape SLS-GLZ-112 20x5 Liner SLS-GLZ-113 45x2 Halspan	Halspan Glazing Tape SLS-GLZ-112 20x5 Liner SLS-GLZ-113 54x2 Halspan	
		Fire Test Reference	WF385622	WF507664	WF508668	WF523941LL & CFR2203091 LL	WF523941 RL & CFR2203091 RL	
1	FireLite Ceramic Glass LTD	5	WF385622	Area: 0.21 Height: 0.70 Width: 0.342	-	-	-	-
2	Pyrodur 60-10 Pilkington UK Ltd	10	RF05036	Area: 0.21 Height: 0.70 Width: 0.342	-	-	-	-
3	Pyrostop EI30-10 (INT) – 2(B) Pilkington UK Ltd	15	CFR1509291 & CFR1708031	Area: 0.21 Height: 0.70 Width: 0.274	-	-	Area: 0.41 Height: 1.75 Width: 0.274	Area: 0.41 Height: 1.75 Width: 0.274
4	Pyrobelite 12 AGC Flat Glass UK	12	CFR2002051 & WF520064	Area: 0.21 Height: 0.70 Width: 0.168	-	-	Area: 0.21 Height: 1.428 Width: 0.168	Area: 0.21 Height: 1.428 Width: 0.168
5	Pyrobel 16 AGC Flat Glass UK	16	WF504390 & WF520063 & WF507664	Area: 0.14 Height: 0.70 Width: 0.182	Area: 0.15 Height: 0.986 Width: 0.182	-	Area: 0.15 Height: 0.986 Width: 0.182	Area: 0.15 Height: 0.986 Width: 0.182

Glass & Glazing System Specification		Maximum Assessed Area (m ²), Height & Width (m)						
		Glass Type Manufacturer	Thickness	System & Manufacturer →	1	2	3	4
							Halspan 60 Glazing Mastic SLS-GLZ-102 3 thick & Halspan 60 Glazing Liner SLS-GLZ-102 54x2	Halspan Glazing Tape SLS-GLZ-112 20x5 Liner SLS-GLZ-113 36x2
				Halspan	Halspan	Halspan	Halspan	Halspan
			Fire Test Reference	WF385622	WF507664	WF508668	WF523941LL & CFR2203091 LL	WF523941 RL & CFR2203091 RL
6	Pyrobel 25 AGC Flat Glass UK	27	WF508668	-	-	Area: 0.33 Height: 1.560 Width: 0.240	-	-
7	Pyroguard Advance 2 FD60/7-1 Pyroguard UK Ltd	7	WF515598	-	-	-	-	-
8	Pyroguard Advance 2 EW60/11-1 Pyroguard UK Ltd	11	WF517609	-	-	-	-	-
9	Pyroguard Advance 2 EW60/11-2 Pyroguard UK Ltd	11	WF523941LL & WF523941RL	Area: 0.21 Height: 0.70 Width: 0.342	-	-	Area: 1.16 Height: 2.104 Width: 0.636	Area: 1.16 Height: 2.104 Width: 0.636
10	Pyroguard EI30 (INT) Pyroguard UK Ltd	15	CFR2203091 LL & CFR2203091 RL	Area: 0.21 Height: 0.70 Width: 0.342	-	-	Area: 1.16 Height: 2.104 Width: 0.636	Area: 1.16 Height: 2.104 Width: 0.636
11	Pyroguard 23 Pyroguard UK Ltd	23	RF13167	-	-	-	-	-

The aperture liner for glazing systems 2 and 4 as detailed in the table above must be grooved into the thickness of the core such that it finishes flush with the aperture edge.

Other Glazing Systems

Glass & Glazing System Specification		Maximum Assessed Area (m ²), Height & Width (m)							
		Glass Type Manufacturer	Thickness	System & Manufacturer →	6	7	8	9	10
							Fire and Acoustic Seals Closed Cell Foam Tape 10x5 & Fire and Acoustic Seals Intumescent Mastic Lining the Aperture 3 thick	Sealmaster Fireglaze 60 (wet) 2 thick & Therm-A-Line Liner 54x2	Sealmaster Fireglaze 60 (wet) 4 thick Sealmaster GL60 Liner 2 thick
				Fire and Acoustic Seals	Sealmaster and Intumescent Seals	Sealmaster	Lorient	Intumescent Seals & Scapa	Fire and Acoustic Seals & Intumescent Seals
			Fire Test Reference	WF515592	LP 636.7-09	RF0006A & RF01056 & RF98051	CFR1708031	WF512028	WF517609 & WF515598
1	FireLite Ceramic Glass LTD	5	WF385622	-	-	-	-	-	-
2	Pyrodur 60-10 Pilkington UK Ltd	10	RF05036	-	-	Area: 0.52 Height:1.98 Width:0.30 & Area: 0.50 Height:1.20 Width:0.48 & Circular Diameter: 0.55	-	-	-
3	Pyrostop EI30-10 (INT) – 2(B) Pilkington UK Ltd	15	CFR1509291 & CFR1708031	Area: 0.49 Height:1.37 Width:0.414	-	Area: 0.49 Height:1.37 Width:0.30 & Area: 0.49 Height:1.20 Width:0.414 & Circular Diameter: 0.55	Area: 0.49 Height:1.37 Width:0.414	Area: 0.49 Height:1.37 Width:0.414	-

Glass & Glazing System Specification		Maximum Assessed Area (m ²), Height & Width (m)								
		Glass Type Manufacturer	Thickness	System & Manufacturer →	6	7	8	9	10	11
							Fire and Acoustic Seals Closed Cell Foam Tape 10x5 & Fire and Acoustic Seals Intumescent Mastic Lining the Aperture 3 thick	Sealmaster Fireglaze 60 (wet) 2 thick & Therm-A-Line Liner 54x2	Sealmaster Fireglaze 60 (wet) 4 thick Sealmaster GL60 Liner 2 thick	System 36/15
				Fire and Acoustic Seals	Sealmaster and Intumescent Seals	Sealmaster	Lorient	Intumescent Seals & Scapa	Fire and Acoustic Seals & Intumescent Seals	
				Fire Test Reference	WF515592	LP 636.7-09	RF0006A & RF01056 & RF98051	CFR1708031	WF512028	WF517609 & WF515598
4	Pyrobelite 12 AGC Flat Glass UK	12	CFR2002051 & WF520064	Area: 0.21 Height: 1.428 Width: 0.168	-	Area: 0.42 Height: 1.773 Width: 0.273 & Circular Diameter: 0.55	-	Area: 0.42 Height: 1.548 Width: 0.273	-	
5	Pyrobel 16 AGC Flat Glass UK	16	WF504390 & WF520063 & WF507664 & F16037	Area: 0.33 Height: 1.509 Width: 0.249	-	Area: 0.33 Height: 1.509 Width: 0.249 & Circular Diameter: 0.55	-	Area: 0.33 Height: 1.509 Width: 0.249	-	
6	Pyrobel 25 AGC Flat Glass UK	27	LP 636.7-09	-	Area: 0.91 Height: 1.368 Width: 0.768	-	-	-	-	
7	Pyroguard Advance 2 FD60/7-1 Pyroguard UK Ltd	7	WF515598	-	-	-	-	-	Area: 0.80 Height: 1.305 Width: 0.618	
8	Pyroguard Advance 2 EW60/11-1 Pyroguard UK Ltd	11	WF517609	-	-	-	-	-	Area: 0.95 Height: 1.305 Width: 0.734	

Glass & Glazing System Specification		Maximum Assessed Area (m ²), Height & Width (m)								
		Glass Type Manufacturer	Thickness	System & Manufacturer →	6	7	8	9	10	11
							Fire and Acoustic Seals Closed Cell Foam Tape 10x5 & Fire and Acoustic Seals Intumescent Mastic Lining the Aperture 3 thick	Sealmaster Fireglaze 60 (wet) 2 thick & Therm-A-Line Liner 54x2	Sealmaster Fireglaze 60 (wet) 4 thick Sealmaster GL60 Liner 2 thick	System 36/15
				Fire and Acoustic Seals	Sealmaster and Intumescent Seals	Sealmaster	Lorient	Intumescent Seals & Scapa	Fire and Acoustic Seals & Intumescent Seals	
				Fire Test Reference	WF515592	LP 636.7-09	RF0006A & RF01056 & RF98051	CFR1708031	WF512028	WF517609 & WF515598
9	Pyroguard Advance 2 EW60/11-2 Pyroguard UK Ltd	11	WF523941LL & WF523941RL	Area: 0.96 Height: 1.308 Width: 0.734	-	Area: 0.52 Height: 1.98 Width: 0.30 & Area: 0.50 Height: 1.20 Width: 0.48 & Circular Diameter: 0.55	-	Area: 0.94 Height: 1.300 Width: 0.726	-	
10	Pyroguard EI30 (INT) Pyroguard UK Ltd	15	CFR2203091 LL & CFR2203091 RL	Area: 0.96 Height: 1.308 Width: 0.636	-	Area: 0.52 Height: 1.98 Width: 0.30 & Area: 0.50 Height: 1.20 Width: 0.48 & Circular Diameter: 0.55	-	Area: 0.94 Height: 1.300 Width: 0.636	-	
11	Pyroguard 23 Pyroguard UK Ltd	23	RF13167	-	-	-	-	-	-	

Other Glazing Systems Continued

Glass & Glazing System Specification		Maximum Assessed Area (m ²), Height & Width (m)					
		Glass Type Manufacturer	Thickness	System & Manufacturer →	12	13	14
							Firestrip 60 20x3 & Norseal Flexible Glazing Liner 50x2
				Hodgson Sealants & Norseal	Sealed Tight Solutions	Norseal	Intumescent Seals
			Fire Test Reference	RF05036	CFR2002051	WF504390	RF13167
1	FireLite Ceramic Glass LTD	5	WF385622	-	-	-	-
2	Pyrodur 60-10 Pilkington UK Ltd	10	RF05036	Area: 1.77 Height: 2.148 Width: 0.98	-	-	-
3	Pyrostop EI30-10 (INT) – 2(B) Pilkington UK Ltd	15	CFR1509291 & CFR1708031	-	-	-	-
4	Pyrobelite 12 AGC Flat Glass UK	12	CFR2002051 & WF520064	-	Area: 0.42 Height: 1.773 Width: 0.273	-	-
5	Pyrobel 16 AGC Flat Glass UK	16	WF504390 & WF520063 & WF507664 & F16037	-	Area: 0.33 Height: 1.744 Width: 0.22	Area: 0.33 Height: 1.744 Width: 0.22	-
6	Pyrobel 25 AGC Flat Glass UK	27	LP 636.7-09	-	-	-	-
7	Pyroguard Advance 2 FD60/7-1 Pyroguard UK Ltd	7	WF515598	-	-	-	-
8	Pyroguard Advance 2 EW60/11-1 Pyroguard UK Ltd	11	WF517609	-	-	-	-
9	Pyroguard Advance 2 EW60/11-2 Pyroguard UK Ltd	11	WF523941LL & WF523941RL	-	-	-	-

Glass & Glazing System Specification		Maximum Assessed Area (m ²), Height & Width (m)					
		12	13	14	15		
Glass Type	Manufacturer	Thickness	System & Manufacturer →	Firestrip 60 20x3 & Norseal Flexible Glazing Liner 50x2	STS105GT 10x5 & ST302 Liner 30x2	Norsound Vision 60 25x3 & Liner 52x2	Mono Ammonium Phosphate 20x2 & Therm-A-Line Liner 54x2
				Hodgson Sealants & Norseal	Sealed Tight Solutions	Norseal	Intumescent Seals
			Fire Test Reference	RF05036	CFR2002051	WF504390	RF13167
10	Pyroguard EI30 (INT) Pyroguard UK Ltd	15	CFR2203091 LL & CFR2203091 RL	-	Area: 0.42 Height: 1.773 Width: 0.273	-	-
11	Pyroguard 23 Pyroguard UK Ltd	23	RF13167	-	-	-	Area: 0.37 Height: 0.66 Width: 0.66

Note:

1. All glass types must be fitted fully in accordance with the manufacturers' tested details/installation requirements, particularly with respect to edge cover and expansion tolerances.
2. Glass types 6 & 11 are fully insulating for 60 minutes in terms of the criteria set out BS 476: Part 20: 1987.



6.3.1 Permitted Glazing Beading and Glass Retention (Timber Beads)

The following sections detail the permitted glazing beading, aperture lining requirements and minimum fixing details for the above detailed glass and glazing systems. Each section deals with a specific type of glazing bead and indicates which glass and or glazing system it is applicable to. Glazing beads shall only be used with the permitted glass and glazing system as identified.

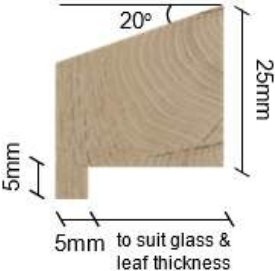
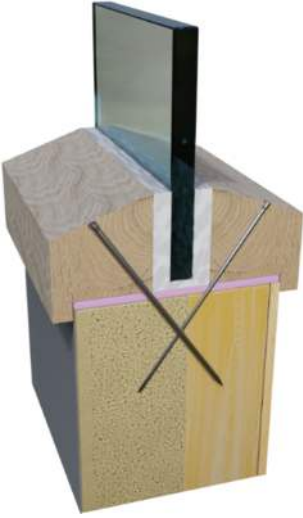

6.3.1.1 Chamfer Beads Option 1

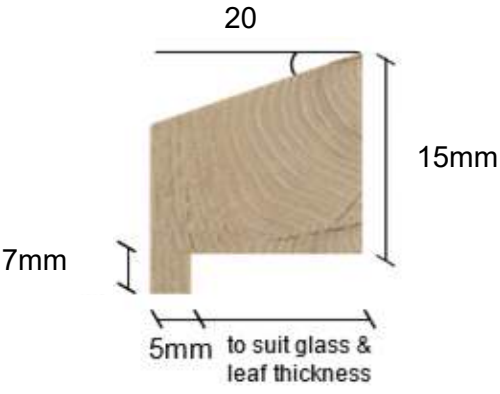
Permitted Glazing Systems (Defined in Section 6.3)	1, 8, 13 & 14
	
<ul style="list-style-type: none"> The above detailed beading may be increased in thickness and height if required, with the dimensions shown for the beading being the minimum. The glazing beads must be created from hardwood (not Beech <i>fagus species</i>) of a minimum 640kg/m³ density. Glazing beads must be retained in position with minimum length of 50mm long steel pins or 50mm long No. 6-8 screws, inserted at 35-40° to the vertical. Fixings must be at 150mm maximum centres and no more than 50mm from each corner. Pneumatically fired pins are acceptable providing the pins meet the specification given in section 6.3.2 below. A 6 – 10mm thick square aperture liner is optionally permitted for use with the above bead providing it is constructed from hardwood (not Beech <i>fagus species</i>) of minimum density 640kg/m³ and glued in position using a UF, PVA or PU type adhesive. The fitting of the glazing seal between the bead and the glass should be in accordance with the manufacturer's instructions. Glass shall be aligned within the aperture using hardwood or non-combustible setting blocks or sections of intumescent liner placed at the bottom horizontal edge only, sized to provide edge cover and expansion allowance as the specific system requires. Glazing system 12 as detailed within section 6.3 may be applied with circular apertures as supported by RF98051. 	

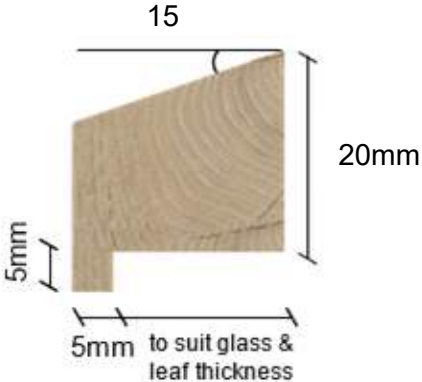

6.3.1.2 Chamfer Beads Option 2

Permitted Glazing Systems (Defined in Section 6.3)	6
	 <ul style="list-style-type: none"> • The above detailed bolection may be increased in thickness and height if required, with the dimensions shown for the bolection being the minimum. • The glazing beads must be created from MDF of a minimum 700kg/m³ density. • Glazing beads must be retained in position with minimum length of 50mm long steel pins or 50mm long No. 6-8 screws, inserted at 35-40° to the vertical. • Fixings must be at 200mm maximum centres and no more than 50mm from each corner. Pneumatically fired pins are acceptable providing the pins meet the specification given in section 6.3.2 below. • A 6 – 10mm thick square aperture liner is required to be fitted for use with the above bead it must be constructed from hardwood (not Beech <i>fagus species</i>) of minimum density 640kg/m³ and glued in position using a UF, PVA or PU type adhesive. • The fitting of the glazing seal between the bead and the glass should be in accordance with the manufacturer's instructions. • Glass shall be aligned within the aperture using hardwood or non-combustible setting blocks or sections of intumescent liner placed at the bottom horizontal edge only, sized to provide edge cover and expansion allowance as the specific system requires

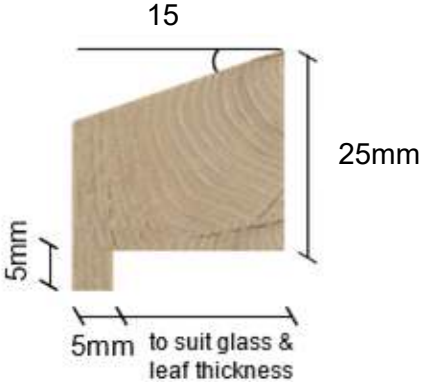

6.3.1.3 Chamfer Beads Option 3

Permitted Glazing Systems (Defined in Section 6.3)	5
	
<ul style="list-style-type: none"> • The above detailed bolection may be increased in thickness and height if required, with the dimensions shown for the bolection being the minimum. • The glazing beads must be created from hardwood (not Beech <i>fagus species</i>) of a minimum 640kg/m³ density. • Glazing beads must be retained in position with minimum length of 50mm long steel pins or 50mm long No. 6-8 screws, inserted at 35-40° to the vertical. Unless utilising cableway – method 4, in which case refer to 10.9.2.4 for instruction. • Fixings must be at 150mm maximum centres and no more than 50mm from each corner. Pneumatically fired pins are acceptable providing the pins meet the specification given in section 6.3.2 below. • A 6 – 10mm thick square aperture liner is optionally permitted for use with the above bead it must be constructed from hardwood (not Beech <i>fagus species</i>) of minimum density 640kg/m³ and glued in position using a UF, PVA or PU type adhesive. • The fitting of the glazing seal between the bead and the glass should be in accordance with the manufacturer's instructions. • Glass shall be aligned within the aperture using hardwood or non-combustible setting blocks or sections of intumescent liner placed at the bottom horizontal edge only, sized to provide edge cover and expansion allowance as the specific system requires 	

6.3.1.4 Chamfer Beads Option 4

Permitted Glazing Systems (Defined in Section 6.3)	15
	
<ul style="list-style-type: none"> • The above detailed bolection may be increased in thickness and height if required, with the dimensions shown for the bolection being the minimum. • The glazing beads must be created from hardwood (not Beech <i>fagus species</i>) of a minimum 640kg/m³ density. • Glazing beads must be retained in position with minimum length of 60mm long steel pins or 60mm long No. 6-8 screws, inserted at 35-40° to the vertical. • Fixings must be at 150mm maximum centres and no more than 50mm from each corner. Pneumatically fired pins are acceptable providing the pins meet the specification given in section 6.3.2 below. • A 6 – 10mm thick square aperture liner is optionally permitted to be fitted for use with the above bead it must be constructed from hardwood (not Beech <i>fagus species</i>) of minimum density 640kg/m³ and glued in position using a UF, PVA or PU type adhesive. • The fitting of the glazing seal between the bead and the glass should be in accordance with the manufacturer's instructions. • Glass shall be aligned within the aperture using hardwood or non-combustible setting blocks or sections of intumescent liner placed at the bottom horizontal edge only, sized to provide edge cover and expansion allowance as the specific system requires 	

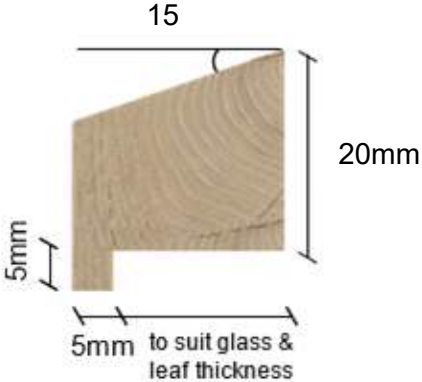
6.3.1.5 Chamfer Beads Option 5

Permitted Glazing Systems (Defined in Section 6.3)	7
	 <ul style="list-style-type: none"> • The above detailed bolection may be increased in thickness and height if required, with the dimensions shown for the bolection being the minimum. • The glazing beads must be created from hardwood (not Beech <i>fagus species</i>) of a minimum 640kg/m³ density. • Glazing beads must be retained in position with minimum length of 70mm long steel pins or 70mm long No. 6-8 screws, inserted at 35-40° to the vertical. • Fixings must be at 150mm maximum centres and no more than 50mm from each corner. Pneumatically fired pins are acceptable providing the pins meet the specification given in section 6.3.2 below. • A 6 – 10mm thick square aperture liner is required to be fitted for use with the above bead it must be constructed from hardwood (not Beech <i>fagus species</i>) of minimum density 640kg/m³ and glued in position using a UF, PVA or PU type adhesive. • The fitting of the glazing seal between the bead and the glass should be in accordance with the manufacturer's instructions. • Glass shall be aligned within the aperture using hardwood or non-combustible setting blocks or sections of intumescent liner placed at the bottom horizontal edge only, sized to provide edge cover and expansion allowance as the specific system requires

6.3.1.6 Square Beads Option 1

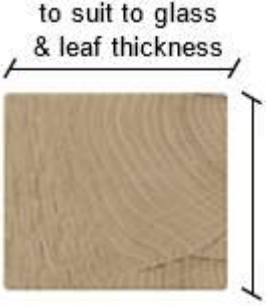
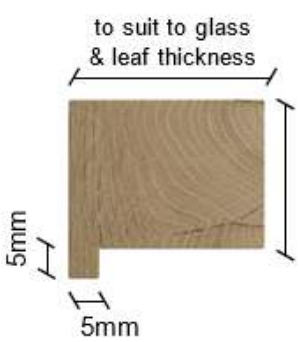
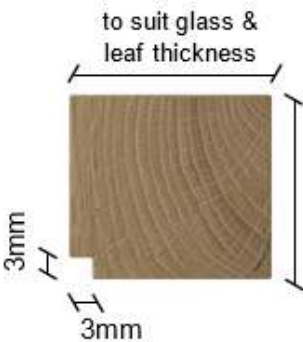
Permitted Glazing Systems (Defined in Section 6.3)	2, 4, 9, 10 & 11	
		
<ul style="list-style-type: none"> The above detailed bolection may be increased in thickness and height if required, with the dimensions shown for the bolection being the minimum. In addition, it is permitted to apply up to a 15° splay to all of the beads as detailed above. The glazing beads must be created from hardwood (not Beech <i>fagus species</i>) of a minimum 640kg/m³ density. Glazing beads must be retained in position with minimum of 50mm long steel pins or 50mm long No. 6-8 screws, inserted at 35-40° to the vertical. Fixings must be at 150mm maximum centres and no more than 50mm from each corner. Pneumatically fired pins are acceptable providing the pins meet the specification given in section 6.3.2 below. A 6 – 10mm thick square aperture liner is required for use with square beads it shall be constructed from hardwood (not Beech <i>fagus species</i>) of minimum density 640kg/m³ and glued in position using a UF, PVA or PU type adhesive. When fitted the intumescent liner, if narrower than 54mm may be rebated by the thickness of the intumescent liner into the top of the hardwood aperture liner. The fitting of the glazing seal between the bead and the glass should be in accordance with the manufacturer's instructions. Glass shall be aligned within the aperture using hardwood or non-combustible setting blocks or sections of intumescent liner placed at the bottom horizontal edge only, sized to provide edge cover and expansion allowance as the specific system requires 		

6.3.1.7 Square Beads Option 2

Permitted Glazing Systems (Defined in Section 6.3)	12
	
<ul style="list-style-type: none"> • The above detailed bolection may be increased in thickness and height if required, with the dimensions shown for the bolection being the minimum. In addition, it is permitted to apply a 15° splay to the bolected bead as detailed above. A splay must not be applied to the bead designs without a bolection. • The glazing beads must be created from hardwood (not Beech <i>fagus species</i>) of a minimum 640kg/m³ density. • Glazing beads must be retained in position with minimum of 60mm long steel No. 6-8 screws, inserted at 35-40° to the vertical. • Fixings must be at 150mm maximum centres and no more than 50mm from each corner. • A 6 – 10mm thick square aperture liner is required for use with square beads and it shall be constructed from hardwood (not Beech <i>fagus species</i>) of minimum density 640kg/m³ and glued in position using a UF, PVA or PU type adhesive. When fitted the intumescent liner, if narrower than 54mm may be rebated by the thickness of the intumescent liner into the top of the hardwood aperture liner. • The fitting of the glazing seal between the bead and the glass should be in accordance with the manufacturer's instructions. • Glass shall be aligned within the aperture using hardwood or non-combustible setting blocks or sections of intumescent liner placed at the bottom horizontal edge only, sized to provide edge cover and expansion allowance as the specific system requires 	

6.3.1.8 Square Beads Option 3

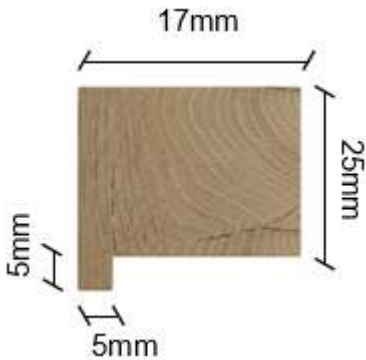
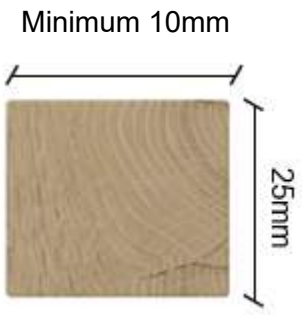
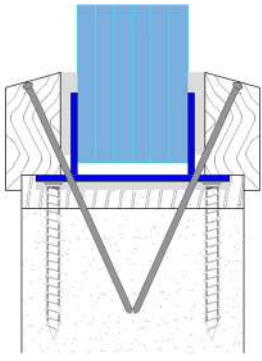
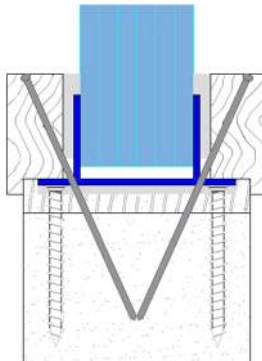
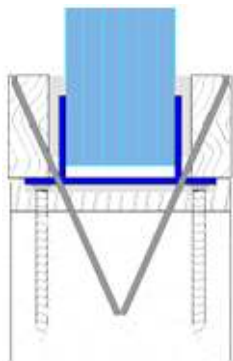
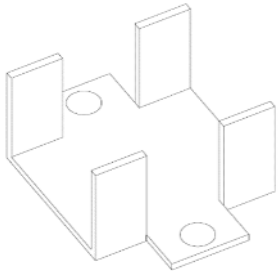
Permitted Glazing Systems (Defined in Section 6.3)	3	
		
Permitted Configurations		
		
	<p>Halspan Glazing Clip – Steel 35 (w) x 47 (d) x 21.5(h) mm</p>	
<ul style="list-style-type: none"> The above detailed bolection may be increased in thickness and height if required, with the dimensions shown for the bolection being the minimum. In addition, it is permitted to apply a 15° splay to the bolected bead as detailed above. A splay must not be applied to the bead designs without a bolection. Flush beads as detailed above, must finish flush with the face of the leaf when applied. Quirks or checks are not permitted. The glazing beads must be created from hardwood (not Beech <i>fagus species</i>) of a minimum 640kg/m³ density. Glazing beads must be retained in position with minimum of 60mm long steel pins or 60mm long No. 6-8 screws, inserted at 25° to the vertical. 		

- Fixings must be at 150mm maximum centres and no more than 50mm from each corner. Pneumatically fired pins are acceptable for the application of the glazing bead providing the pins meet the specification given in section 6.3.2 below.
- In addition to the detailed glazing beads, the glass is to be retained by the tested glazing clip system. Clips meeting the specification given above shall be applied to the vertical edges at no greater than 100mm from corners and 320mm centres. 1No. clip shall also be applied to the top and bottom horizontal edges centrally within the aperture. Clips shall be fixed with 2No. 4mm x 40mm long steel screws per clip as tested.
- A 6 – 10mm thick square aperture liner is required for use with the above beads and it shall be constructed from hardwood (not Beech *fagus species*) of minimum density 640kg/m³ and glued in position using a UF, PVA or PU type adhesive. When fitted the intumescent liner, if narrower than 54mm may be rebated by the thickness of the intumescent liner into the top of the hardwood aperture liner.
- The fitting of the glazing seal between the bead and the glass should be in accordance with the manufacturer's instructions.
- Glass shall be aligned within the aperture using hardwood or non-combustible setting blocks or sections of intumescent liner placed at the bottom horizontal edge only, sized to provide edge cover and expansion allowance as the specific system requires

Note: The tested door leaf was 60mm thick (54mm Prima with 3mm MDF facings applied), the flush glazing bead option has been retained with the beads at the dimension tested as illustrated above.

Given the performance achieved within the tested design it is the opinion of Warringtonfire that the above detailed beading system when utilised with the permitted glass type and glazing system from section 6.3 will achieve 60 minutes fire resistance performance within a 54mm thick door leaf.

6.3.2 Glazing Pins for Glazing Within Leaf

The following pin specification is permitted and has been considered suitable for applications where a pin fixing is permitted for glazing beads:

Option 1 – Round, Oval & Rectangular Pins

The following dimension of pin has been approved for round, oval and rectangular shaped pins which are hand applied:

- Minimum Standard Wire Gauge (SWG) 16.
- Minimum cross section area of 2.03mm².
- Minimum linear dimension of 1.6mm in any direction, see figure below. The maximum pin diameter or any linear dimensions may be no greater than 2.0mm.



Option 2 – Gun (Pneumatically) Fired Rectangular Pins

The following dimension of rectangular pin has been deemed suitable for gun (pneumatically) fired applications.

- Minimum Standard Wire Gauge (SWG) 16.
- Minimum cross section area of 2.24mm².
- Minimum linear dimensions as shown in the figure.
- The 1.6mm dimension is predominately oriented perpendicular to the glass, where possible.
- The maximum pin diameter or any linear dimensions may be no greater than 2.0mm.

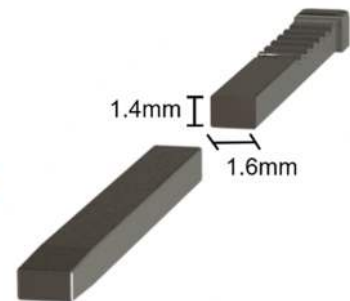

Pins with dimensions less than those stated above are not covered by this assessment.

6.4 Single Pane Glass and Glazing Systems (Steel Beading)

The tested and assessed glass and glazing system(s) combinations, detailed within the table below may be used, subject to the limitations and scope detailed in section 6.1 above.

The table below specifies the maximum assessed height, width & area of glazing for each permitted glass type and glazing system.

The numerical figures in the main body of the table are the maximum height, width (m) & area of glass (in m²) that is considered acceptable for an individual glazed aperture, based upon the specific system. Where a '-' is applied the glass type and glazing system has not been considered compatible.

Glass & Glazing System Specification		Maximum Assessed Area (m ²), Height & Width (m)							
Glass Type Manufacturer	Thickness	System & Manufacturer→	1	2	3	4	5		
			R90 Glazing Liner & 4mm thickness R90 SLS-GLZ-102 Glazing Mastic filling glazing void.	Kerafix SL2000 Glazing Liner 30mm x 2mm & Kerafix SL2000 Tape: 25mm x 5mm applied to bead to glass junction 15mm x 3mm applied to bead to leaf face junction	2mm thick Therm-A-Line Liner & Kerafix SL2000 Tape: 2mm thick applied to bead to glass junction and to bead to leaf face junction, width matching dimension of glazing bead	2mm thick Lorient Liner & Kerafix SL2000 Tape: 2mm thick applied to bead to glass junction and to bead to leaf face junction, width matching dimension of glazing bead	2mm thick Lorient Liner & 23mm x 2mm applied to bead to leaf junction Kerafix SL2000 Tape: 20mm x 4mm applied to bead to glass junction	Halspan Limited	ROLFKUHN GMBH
Fire Test Reference	WF380349	FRR-2010/2942	FRR-2102/4628	FRR-2107/2288	FRR-2110/1497 & FRR-2110/1498				
1	Keralite Vetrotech Saint Gobain	5	FRR-2102/4628 & FRR-2107/2288 & FRR-2110/1497 & FRR-2110/1498	-	-	Area: 1.00 Height: 1.844 Width:0.544	Area: 0.35 Height:1.671 Width:0.219	Area: 0.3 Height:1.5 Width:0.2	
2	FireLite Ceramic Glass LTD	5	WF380349 & FRR-2010/2942	Area: 0.12 Height:0.600 Width:0.200	Area: 0.18 Height:0.595 Width:0.308	-	-	-	

Note:

- All glass types must be fitted fully in accordance with the manufacturers' tested details/installation requirements, particularly with respect to edge cover and expansion tolerances.

6.4.1 Permitted Glazing Beading and Glass Retention (Steel Beads)

The following sections detail the permitted glazing beading, aperture lining requirements and minimum fixing details for the above detailed glass and glazing systems. Each section deals with a specific type of glazing bead and indicates which glass and or glazing system it is applicable to. Glazing beads shall only be used with the permitted glass and glazing system as identified.

6.4.1.1 Steel 'Z' Beads

Each of the tested glass types and glazing systems when tested used a steel 'Z' profiled beading. The tables in the following sections provides the minimum dimensional details for each of the above tested glass types and glazing systems.

When using the below detailed glazing beads, the overall thickness of the finished door leaf under the 'Z' bead needs to be considered when specifying the glazing bead depth to ensure adequate compression of the glazing seals.

The dimension shown as 'To Suit Finished Leaf Thickness' in the subsequent sections will depend on the finished leaf thickness.

The table below details the required shoulder dimension, this dimension shall be increased directly proportionally to any increase in thickness of the leaf for example the application of decorative and protective finishes.

Glazing System	Required Shoulder Dimension (54mm Leaf Thickness)
1	18.5mm
2	21.5mm
3	22.5mm
4	26.5mm
5	23mm

6.4.1.1.1 Steel 'Z' Bead Option 1

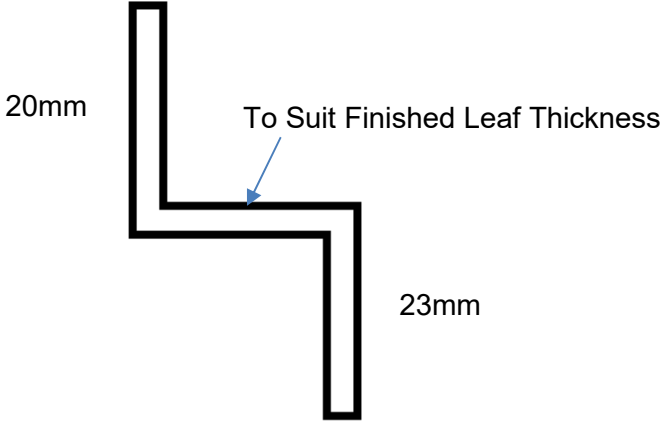
Permitted Glazing Systems (Defined in Section 6.4)	3 & 5
	
<ul style="list-style-type: none">• The glazing beads must be created from steel with a thickness of 1.5mm with fully welded corners.• Glazing beads must be retained in position with minimum length of 38 - 40mm long steel screws, inserted at 90° to the face of the glass into the leaf face a minimum of 10mm from the glazed aperture.• Fixings must be at 140mm maximum centres and no more than 27mm from each corner.• The fitting of the glazing seal between the bead and the glass should be in accordance with the manufacturer's instructions.• Glass shall be aligned within the aperture using non-combustible setting blocks placed at the bottom horizontal edge only, sized to provide edge cover and expansion allowance as the specific system requires	

6.4.1.1.2 Steel 'Z' Bead Option 2

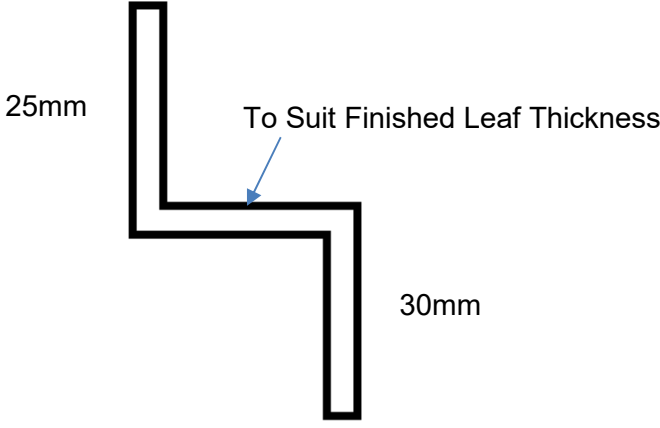
Permitted Glazing Systems (Defined in Section 6.4)	1 & 2
	
<ul style="list-style-type: none">• The glazing beads must be created from steel with a thickness of 1.5mm with fully welded corners.• Glazing beads must be retained in position with minimum length of 38 - 40mm long steel screws, inserted at 90° to the face of the glass into the leaf face a minimum of 10mm from the glazed aperture.• Fixings must be at 140mm maximum centres and no more than 27mm from each corner.• The fitting of the glazing seal between the bead and the glass should be in accordance with the manufacturer's instructions.• Glass shall be aligned within the aperture using non-combustible setting blocks placed at the bottom horizontal edge only, sized to provide edge cover and expansion allowance as the specific system requires	

6.4.1.1.3 Steel 'Z' Bead Option 3

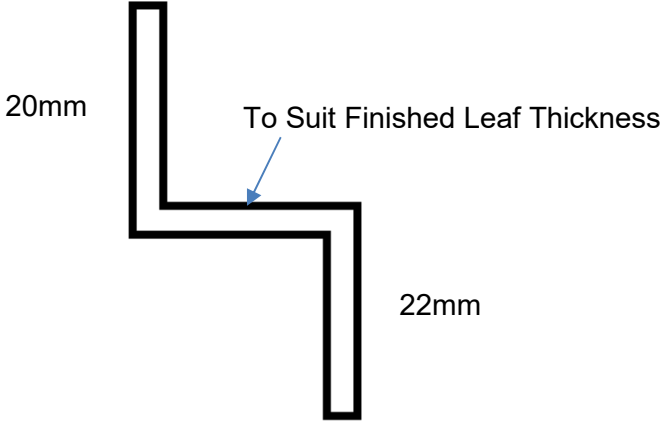
Permitted Glazing Systems (Defined in Section 6.4)	4
	
<ul style="list-style-type: none">• The glazing beads must be created from steel with a thickness of 2mm with fully welded corners.• Glazing beads must be retained in position with minimum length of 40mm long steel screws, inserted at 45° to the face of the glass into the nominal centre of the shoulder of the glazing bead.• Fixings must be at 140mm maximum centres and no more than 27mm from each corner.• The fitting of the glazing seal between the bead and the glass should be in accordance with the manufacturer's instructions.• Glass shall be aligned within the aperture using non-combustible setting blocks placed at the bottom horizontal edge only, sized to provide edge cover and expansion allowance as the specific system requires	

6.5 Double Glazed Units & Glazing Systems

The glazing system must be one of the following proprietary tested systems.

The table below specifies the maximum assessed height, width & area of glazing for each permitted glass type and glazing system. The numerical figures in the main body of the table are the maximum area of glass (in m²) that is considered acceptable for an individual glazed aperture, based upon the specific system.

The total area of all glazed apertures must not exceed that stated in section 6.1 above.

Test reference WF512409 was undertaken with the left hand doorset opening in towards the fire exposure and the right hand doorset out away from the fire exposure. The double-glazed units fitted into the leaves were tested in both orientations due to the tested arrangements.

Although integrity failures to Doorset A are noted at 24 and 58 minutes neither of these are localised or attributable to the glass or glazing system. Doorset B achieved 62 minutes fire resistance integrity performance. It is therefore deemed suitable evidence for the glazing option, noted below, to be fitted in either orientation.

Glass & Glazing System Specification		Maximum Assessed Area (m ²), Height & Width (m)	
Glass Type Manufacturer	System & Manufacturer →	1	
		Halspan SLS-GLZ-112 20mm x 5mm uncompressed & SLS-GLZ-113 Glazing Liner 54mm x2mm Pyroplex – PFRS310WT Fire Rated Silicone capping the top of the glazing system and between the glazing bead and the leaf face	
		Halspan & Pyroplex	
		Fire Test Reference	WF512409
1	AGC Pyrobelite 12, 12.3mm thick & AGC Stratobel Clearite 33.2 with iplus 1.0 pos.2, 6.8mm thick Hollow box steel spacer 5.5mm wide Total Unit Thickness 25.1mm	WF512409	Area 0.118 Height: 0.47 Width:0.271

Note:

1. All glass types must be fitted fully in accordance with the manufacturers' tested details/installation requirements, particularly with respect to edge cover and expansion tolerances.
2. Based on the testing within WF512409 it is permitted to include lead within the double-glazed unit to the maximum volume of lead that was tested. Units without lead are permitted.

6.5.1 Glazing Beading Arrangement – Double Glazed Units

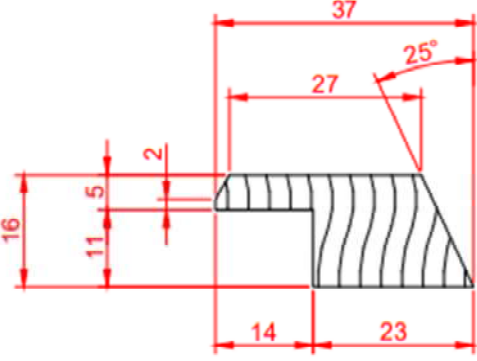
Permitted Glazing Systems (As defined in section 6.5)	1
	
<ul style="list-style-type: none">• The above detailed bolection may be increased in thickness and height if required, with the dimensions shown being the minimum shown for the bolection.• The 11mm depth of bead detailed above must be increased subject to leaf thickness increases.• The glazing beads must be created from hardwood (not Beech <i>fagus species</i>) of a minimum 640kg/m³ density.• Glazing beads must be retained in position with PU adhesive as well as mechanical fixings with a minimum length of 50mm long steel pins or 50mm long No. 6-8 screws, inserted at 30-40° to the vertical.• Fixings must be at 150mm maximum centres and no more than 50mm from each corner. Pneumatically fired pins are acceptable providing the pins meet the specification given in section 6.5.2 below.• A 6 – 10mm thick square aperture liner is required for use with the above bead and shall be constructed from hardwood (not Beech <i>fagus species</i>) of minimum density 640kg/m³ and glued in position using a UF, PVA or PU type adhesive.• The fitting of the glazing seal between the bead and the glass should be in accordance with the manufacturer's instructions.• Glass shall be aligned within the aperture using hardwood or non-combustible setting blocks placed at the bottom horizontal edge only, sized to provide edge cover and expansion allowance as the specific system requires	

6.5.2 Glazing Pins for Glazing Within Leaf

The following pin specification is permitted and has been considered suitable for applications requiring a pin fixing to glazing beads:

Option 1 – Round, Oval & Rectangular Pins

The following dimension of pin has been approved for round, oval and rectangular shaped pins which are hand applied:

- Minimum Standard Wire Gauge (SWG) 16.
- Minimum cross section area of 2.03mm².
- Minimum linear dimension of 1.6mm in any direction, see figure below. The maximum pin diameter or any linear dimensions may be no greater than 2.0mm.



Option 2 – Gun (Pneumatically) Fired Rectangular Pins

The following dimension of rectangular pin has been deemed suitable for gun (pneumatically) fired applications.

- Minimum Standard Wire Gauge (SWG) 16.
- Minimum cross section area of 2.24mm².
- Minimum linear dimensions as shown in the figure.
- The 1.6mm dimension is predominately oriented perpendicular to the glass, where possible.
- The maximum pin diameter or any linear dimensions may be no greater than 2.0mm.

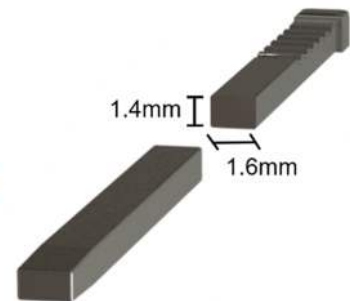

Pins with dimensions less than those stated above are not covered by this assessment.

6.6 Hygeno IntaVista & FlushView Units

These glazing units have been successfully tested as shown in the table below. The table identifies the fire test reference, unit overall dimensions and the fire glass included within the Hygeno unit.

Test Report	Hygeno Product	Unit			Fire Glass
		Height	Width	Thickness	
CFR1909241	FlushView	750	500	54	5mm Firelite
	IntaVista	750	500	54	5mm Firelite
WF509421	FlushView	750	500	58	Pyroguard EI30 15mm
	IntaVista	750	500	58	Pyroguard EI30 15mm
WF509420	FlushView	1500	200	58	Pyroguard EI30 15mm
	IntaVista	1500	200	58	Pyroguard EI30 15mm

The Hygeno units are therefore permitted for use within the following specification as detailed below:

- Unit Dimensions:
 - a. For Firelite or Pyroguard EI30 based units:
 - i. Maximum height of glazing unit: 750mm
 - ii. Maximum width of glazing unit: 500mm
 - iii. Maximum glazed area: 0.375 m²
 - b. For Pyroguard EI30 based units only:
 - i. Maximum height of glazing unit: 1500mm
 - ii. Maximum width of glazing unit: 200mm
 - iii. Maximum glazed area: 0.3 m²

In all cases the overall unit thickness must be 54mm to 58mm thick, with the variance in size coming from the dimensions of the spacer. The width of the spacers shall be kept in the same ratio as tested.

Description of the units follows in sections 6.6.1 and 6.6.2 which include permitted installation details relevant for each of the units.

Additionally, to the above requirements, due to the complex nature of these glazing units, further installation guidance for both the FlushView and IntaVista glazing systems should be sought from the manufacturer.

6.6.1 Hygeno IntaVista Unit

Hygeno Flush Fit IntaVista is supplied as a unit and comprises a central 5mm Firelite or Pyroguard EI30 15mm pane, with one pane of 6mm toughened glass to one side and with 2 panes of 6mm toughened glass, with an extra layer of movable annealed obscuring glass with a stainless-steel handle to the other side.

This unit has been tested with the operating lever exposed to furnace conditions (CFR1909241) and on the unexposed face (WF509421 & WF509420). When the operating lever was orientated towards the furnace conditions it was observed that the two panes of 6mm thick toughened glass detached and fell away into the furnace prior to 20 minutes. This demonstrates that the toughened glass layers are essentially sacrificial layers, which are not in isolation, essential in order to maintain the integrity performance of the unit in fire test conditions. Furthermore, this indicates that the lever which could under test conditions act as a heat sink would fall away with the toughened glass reducing the risk of premature failure of the fire resisting glass within the centre of the unit.

On this basis it is assessed that, subject to the fire resisting pane within the units construction remaining uninterrupted, the unit can be considered fire resisting from both sides with either central fire resisting glass type.

	Make/type	Dimension (mm)	Key to figures
Triple glazed unit	Thermally Toughened to BS EN 12150 with Polished Edges ¹	6 thick	1
	Thermally Toughened to BS EN 12150 with Polished Edges ¹		
	Annealed glass ¹	4 thick	2
	Firelite ceramic glass	5 thick	3
	Pyroguard EI30	15 thick	
	Aluminium spacer bar ¹	15.5 / 10 / 6 wide	4
Expansion allowance	4mm on all edges		-
Lining glazing aperture rebate	Vertical edges – MgO board 40mm wide x 12mm deep		5
	Horizontal edges – MgO board 2No 14mm wide x 12mm deep		6
Fixings	Vertical edges – 40mm long pins or No. 6 screw centrally fitted within the MgO board in line with the glass as depicted overleaf, located at 50mm from the corners and spaced at 150mm centres.		7
	Horizontal edges – 40mm long pins or No. 6 screws located at 50mm from the corners and spaced at 150mm centres at 30° to the plane of the glass. Fixing required for each of the calcium silicate blocks. As depicted overleaf.		8
Intumescent materials	Horizontal edges – Central glass pane is bedded onto Everbuild Firemate mastic, which is applied fully filling the 12mm wide x 12mm deep void between the two MgO boards		9
	50 x 2mm Interdens® (comprising 50 x 2mm liner + 1mm – 2mm packing sections) fitted centrally to the leaf thickness and interrupted by the central glazing pane at the horizontals		10
	All edges – bead of Otto Chemie S94 or Forgeway Formoa 055 sealant applied between outer panes of toughened glass and door core around the perimeter of glazed unit (approx. 4mm deep bead)		11

Notes:

1. As detailed within section 2.1 the components must not be changed from the tested detail. Alternatives have not been considered.

Horizontal section detail

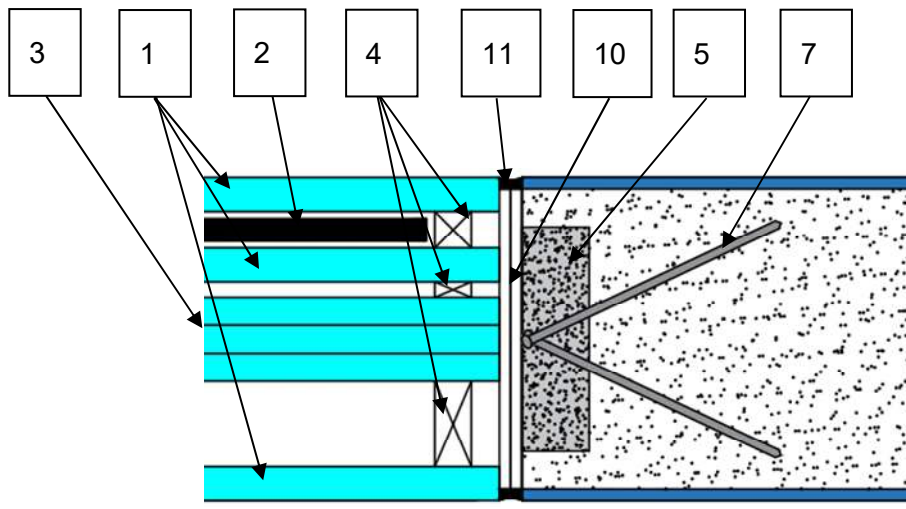

Vertical section detail

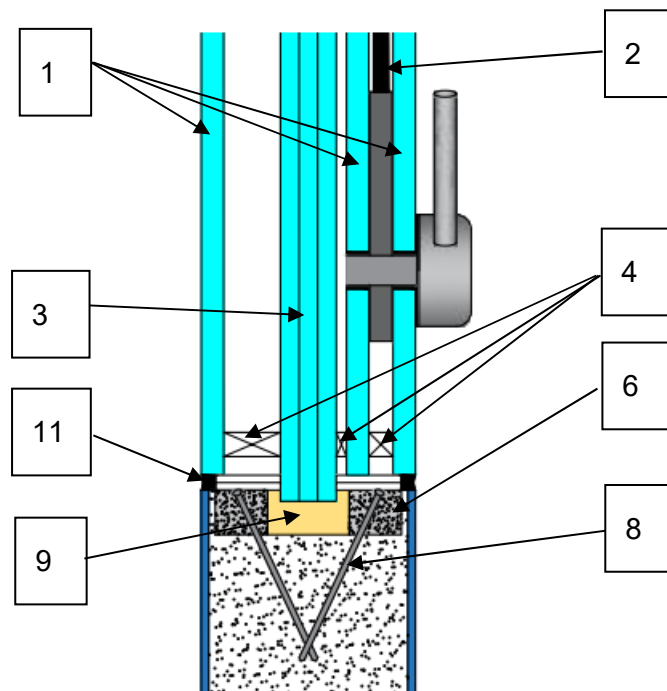

6.6.2 Hygeno FlushView Unit

Hygeno FlushView is supplied as a unit and comprises a central 5mm FireLite or Pyroguard EI30 15mm pane with 6mm toughened glass to either face.

This unit is symmetrical and therefore can be considered fire resisting from both sides supported by the testing undertaken in WF509421, WF509420 & CFR1909241.

The table below provides information on how the unit is constructed and installed. There is multiple options for some items which may be considered.

	Make/type	Dimension (mm)	Key to figures
Triple glazed unit	Thermally Toughened to BS EN 12150 with Polished Edges ¹	6 thick	1
	Thermally Toughened to BS EN 12150 with Polished Edges ¹		
	Firelite ceramic glass	5 thick	2
	Pyroguard EI30	15 thick	
	Aluminium spacer bar ¹	15 wide	3
Expansion allowance	4mm on all edges		-
Lining glazing aperture rebate	Vertical edges – MgO board 40mm wide x 12mm deep		4
	Horizontal edges – MgO board 2No 14mm wide x 12mm deep		5
Fixings	Vertical edges – 40mm long pins or No. 6 screw centrally fitted within the MgO board in line with the glass as depicted overleaf, located at 50mm from the corners and spaced at 150mm centres.		6
	Horizontal edges – 40mm long pins or No. 6 screws located at 50mm from the corners and spaced at 150mm centres at 30° to the plane of the glass. Fixing required for each of the calcium silicate blocks. As depicted overleaf.		7
Intumescent materials	Horizontal edges – Central glass pane is bedded onto Everbuild Firemate mastic, which is applied fully filling the 12mm wide x 12mm deep void between the two MgO boards		8
	50 x 2mm Interdens® (comprising 50 x 2mm liner + 1mm – 2mm packing sections) fitted centrally to the leaf thickness and interrupted by the central glazing pane at the horizontals		9
	All edges – bead of Otto Chemie S94 or Forgeway Formoa 055 sealant applied between outer panes of toughened glass and door core around the perimeter of glazed unit (approx. 4mm deep bead)		10

Notes:

1. As detailed within section 2.1 the components must not be changed from the tested detail. Alternatives have not been considered.

Horizontal section detail

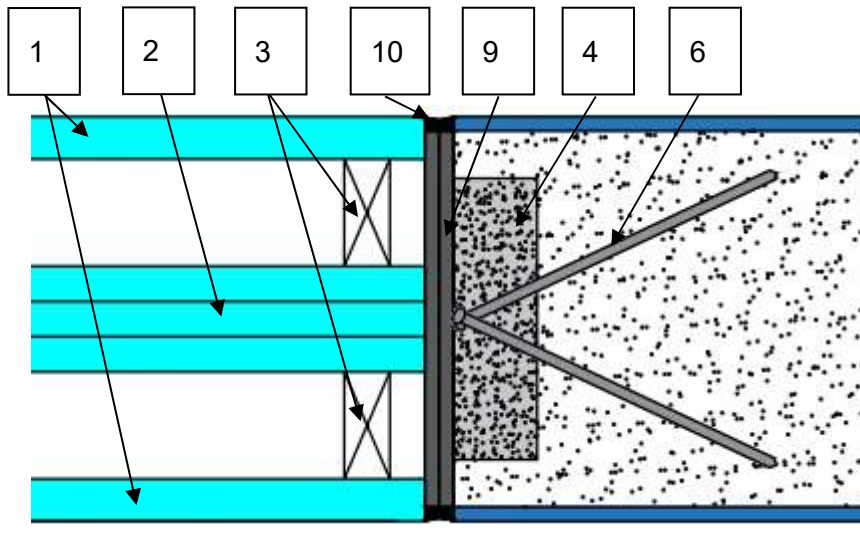

Vertical section detail

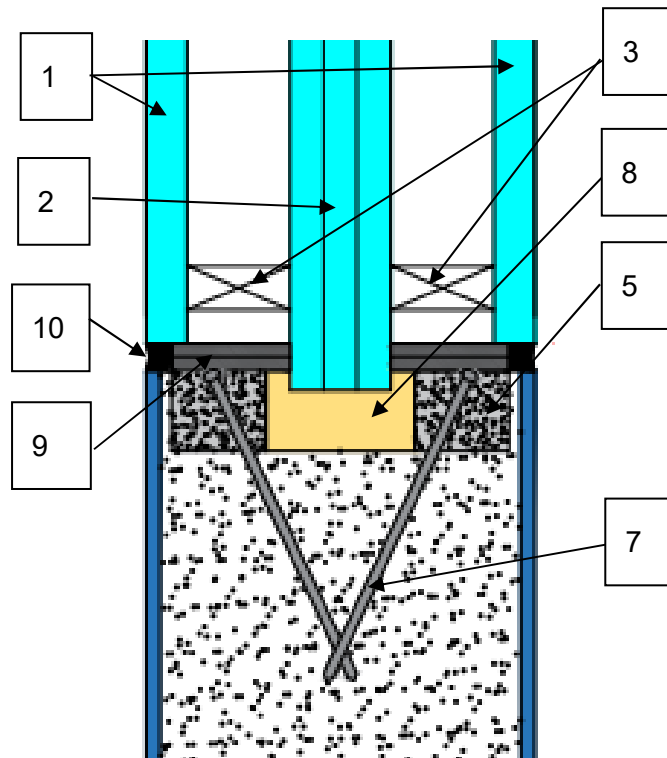

6.7 Zeroplus Slimport

The Zeroplus Slimport circular glazing system is constructed from steel and has been tested within Warres117483 as summarised within section 3. The test included a Zeroplus Slimport SP250 and a Zeroplus Slimport SP450 which was installed within a 54mm thick timber-based door leaf. It was observed that the first failure mode was recorded at 71 minutes test duration. Supporting the use of the glazing system.

The Zeroplus Slimport glazing system is permitted in the following dimensions:

- 250mm
- 450mm

When utilised the Zeroplus Slimport glazing system shall be positioned within the requirements of section 6.1.

The following intumescent specification shall be applied:

- Zero FS2002, 1.6mm (t) x 9.5mm (w), applied to both faces of the glass between the glass and the bead.
- Zero FS4004, 1.6mm (t) x 54mm (w), applied lining the aperture within the leaf.

The glass type permitted for the Zeroplus Slimport glazing system is as follows:

Pyrocet, 6mm thick, modified toughened glass.

When applied the glass shall be 25mm smaller than the chosen Zeroplus Slimport glazing system to allow for expansion tolerances as tested.

Fixings and glass retention techniques shall be as tested within Warres117483.

7 Door Frame Construction

The minimum sizes for frame cross-section may be subject to the use of specific components. Restrictions on the use of specific items of hardware with any individual frame type can be found within the relevant sub-section of section 10.

Rounded or rebated quirk edges to door frames are not permitted. Except for up to a 2mm radius to remove the arris.

7.1 Details for Frame 1

On the basis of the testing cited in section 3.1, the door frames listed below are the minimum size and density which have been successfully tested and assessed by this report. The frame must be constructed to meet the following specification for single and double acting frames, where applicable.

Frame specification				
Frame type	Material	Minimum section size (mm)	Minimum density (kg/m ³)	Acceptable leaf type
1	Hardwood: (see section 2.1) The use of Beech (<i>Fagus species</i>) is NOT permitted.	Frame: 70 (d) x 32 (w) (excluding stop) Stop: 12 (w) (integral or planted on)	640	Leaf 1

Note:

Minimum section size is subject to use of double acting configuration and the use of transomed overpanel (see frame details below).

Minimum section size is also subject to the use of the shadow gap installation (see section 11.2.4) and hardware requirements (see section 10).

Architraves may be rebated into the cross section of the frame in a tongue and groove arrangement providing:

- The tongue fully fills the groove provided within the frame material and the groove is no greater than 10mm wide x 10mm deep.
- The groove must be positioned no closer than 10mm from any frame edge.
- The groove must not coincide with the rebate for items of rebated building hardware.
- The architrave when applied must be bonded on all edges with PU or PVA adhesive.
- The material of the architrave must be the same specification including species as the frame material.

Back-to-Back Frames

Based on the testing detailed within CFR2105131 it has been possible to consider the jointing of 2No. Latched, Single leaf, single acting doorset (LSASD) designs within a single aperture, providing the following criteria is adhered to:

- Each of the two frames are constructed in accordance with the specification of Frame 1 above. Except the minimum depth is increased to 99mm. Each frame must have a stop which is a minimum of 15mm wide x 32mm deep.
- The maximum leaf dimensions for both doorsets is 2040mm high x 926mm wide as tested, door leaves of smaller dimensions are permitted.
- The door leaves must be hung from the jambs which are adjacent to the supporting structure.
- The leaves must be hung on butt hinges.
- Only latched, single leaf, single acting configurations of doorsets may be installed in this manner, when fitted the door leaves must be in line and open in the same direction.
- Fanlights, Sidelights, Sidepanels or Overpanels are not permitted in this configuration.
- The jointing of the frames shall be in accordance with the jointing method outlined below.

Jointing Method for Back-to-Back Frames

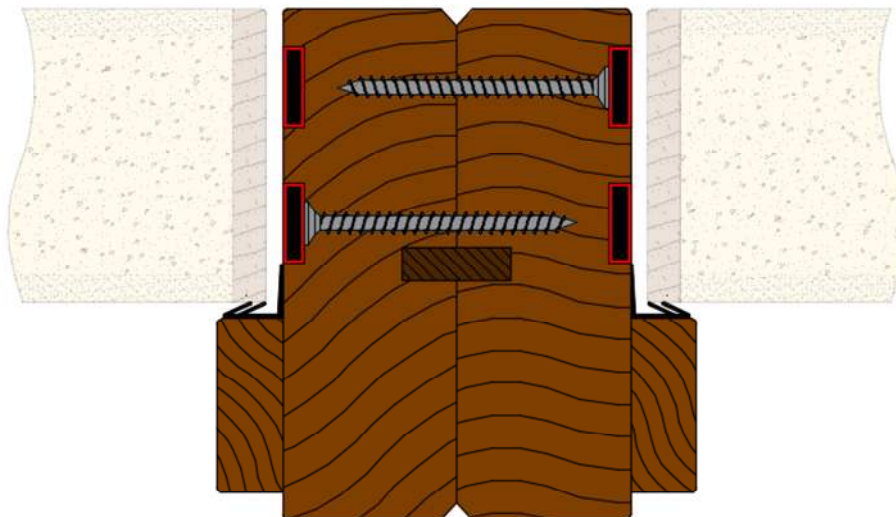

The left hand doorset shall be fixed to the right hand doorset with $\text{Ø}4$ x 50 steel countersunk screws, affixed through closing jamb set nominally 38mm from opening face, this may be below intumescent, set 50mm up, 50mm down with a total of 4No. overall equispaced.

The right hand doorset shall be fixed to the left hand doorset with $\text{Ø}4$ x 50 steel countersunk screws, affixed through closing jamb set nominally 13mm from opening face this may be below intumescent, set 50mm up, 50mm down with a total of 4No. overall equispaced.

An 11mm wide x 6mm deep rebate must be positioned centrally to the depth of both frames to facilitate an MDF coupler to be applied between the frames. The MDF coupler must be bonded in position with PU adhesive as tested.

The frame jamb adjacent to the supporting structure must be fixed in line with the requirements of section 11.

The coupled frame jamb must be fixed to the floor with steel angle bracket as tested, using fixings which penetrate the floor level by a minimum of 50mm.

7.1.1 Standard frame detail

The diagram below shows detail of the standard frame construction. Minimum section is permitted in two sizes subject to the use of transom overpanel. Any radius to the lipping must comply with section 5.3.

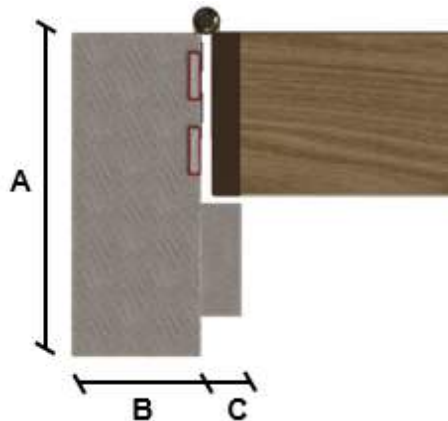

A: Frame depth = 70mm minimum

B: Frame width = 32mm minimum

C: Stop width = 12mm minimum

Minimum transom section size:

A: Frame depth = 70mm minimum

B: Frame width = 44mm minimum

C: Stop width = 12mm minimum

7.1.2 Scalloped frame detail for double acting doorsets

The diagram below shows detail of the scalloped frame construction hanging edge only. When using scalloped frames for double acting doorsets, the groove for the specified intumescent strips must be as shown below and to the correct depth. Where utilising scalloped frames for double acting doorsets, any radius to the lipping must comply with section 5.3.1.

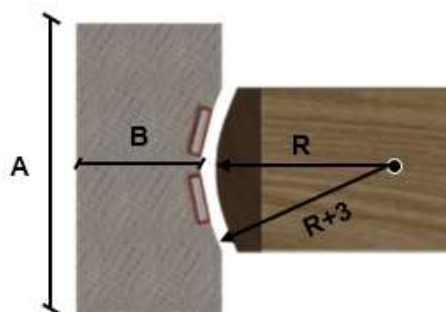

A: Frame depth = 93mm minimum

B: Frame width = 32mm minimum

R: Radius from floor spring or pivot

Each face of the door leaf must be set back from each face of the wall by a minimum of 19.5mm. i.e from both sides. The face of the leaf must also be a minimum of 19.5mm from either face of the frame.

7.1.3 Square frame detail for double acting doorsets

The diagram below shows detail of the square frame construction for the closing edge of a double acting doorset. It is not permitted to use this detail for the hanging edge of a double acting doorset. Any radius to the lipping must comply with section 5.3.1.

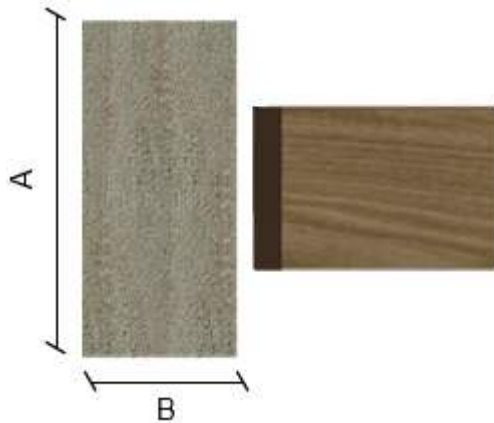

A: Frame depth = 93mm minimum

B: Frame width = 32mm minimum

7.2 Details for Frame 2

The door frame listed below is the minimum size and density which have been successfully tested and assessed by this report. The frame must be constructed to meet the following specification for single and double acting frames, where applicable.

Frame specification				
Frame type	Material	Minimum section size (mm)	Minimum density (kg/m ³)	Acceptable leaf type
2	Steamed Beech (<i>Fagus species</i>) (see section 2.1)	Frame: 90 (d) x 32 (w) (excluding stop) Stop: 15 (w) (integral or planted on)	660	Leaf 1

Note:

Minimum section size is subject to use of double acting configuration (see frame details below) and hardware requirements (see section 10).

All edges of the leaf must be lipped in accordance with either 5.3.1 or 5.3.3.

The use of shared transomed overpanels is not permitted with Frame 2.

7.2.1 Standard frame detail

The diagram below shows detail of the standard frame construction. Any radius to the lipping must comply with section 5.3.1 or 5.3.3.

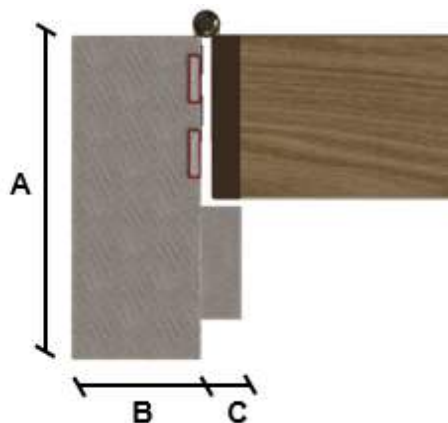

A: Frame depth = 90mm minimum

B: Frame width = 32mm minimum

C: Stop width = 15mm minimum

7.2.2 Scalloped frame detail for double acting doorsets

The diagram below shows detail of the scalloped frame construction hanging edge only. When using scalloped frames for double acting doorsets, the groove for the specified intumescent strips must be as shown below and to the correct depth. Where utilising scalloped frames for double acting doorsets, any radius to the lipping must comply with section 5.3.1 or section 5.3.3.

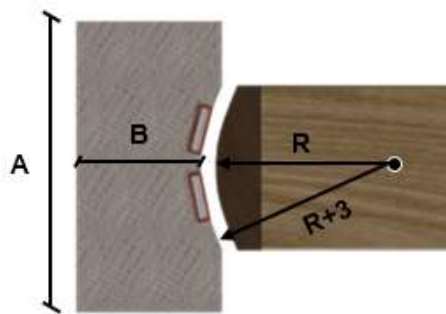

- A: Frame depth = 150mm minimum
- B: Frame width = 41mm minimum
- R: Radius from floor spring or pivot

Each face of the door leaf must be set back from each face of the wall by a minimum of 48mm. i.e from both sides. The face of the leaf must also be a minimum of 48mm from either face of the frame.

7.2.3 Square frame detail for double acting doorsets

The diagram below shows detail of the square frame construction for the closing edge of a double acting doorset. Any radius to the lipping must comply with section 5.3.1 or 5.3.3.

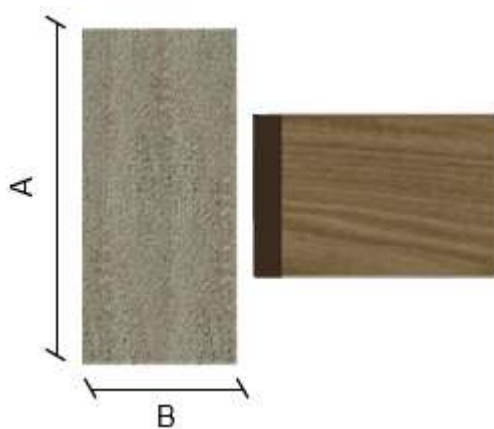

- A: Frame depth = 150mm minimum
- B: Frame width = 32mm minimum

7.3 Details for Frame 3

The door frame listed below is the minimum size and density which have been successfully tested and assessed by this report. The frame must be constructed to meet the following specification for single acting frames, where applicable.

Frame specification				
Frame type	Material	Minimum section size (mm)	Minimum density (kg/m ³)	Acceptable leaf type
3	MDF – solid lengths	Frame: 70 (d) x 30 (w) (excluding stop) Stop: 12 (w) (integral or planted on)	700	Leaf 1
	Alternative material Stop Hardwood: (see section 2.1) The use of Beech (<i>Fagus species</i>) is NOT permitted. (F15012b)	Stop: 12 (w) (planted on)	640	Leaf 1

Note:

All edges of the leaf must be lipped in accordance with 5.3.1.

The use of shared transomed overpanels is not permitted with Frame 3.

Minimum section size is also subject to the use of the shadow gap installation (see section 11.2.4) and hardware requirements (see section 10).

The stop may be glued in position as part of the frame section assembly, in this situation the stop must additionally be pinned and is considered a planted on stop as detailed above.

It is possible to increase the cross-sectional dimensions of the above detailed MDF frame by bonding additional solid lengths together with TensorGrip L71 sprayable moisture cured adhesive. This is supported by the testing demonstrated within WF509420. When this option is used the minimum thickness of any individual length shall be no less than 18mm (t) and the minimum thickness adjacent to the reveal is no less than 25mm (t). This only applies when the doorset either:

1. Does not include a stop (double acting arrangements) or
2. Includes a planted on stop

7.3.1 Standard frame detail

The diagram below shows detail of the standard frame construction. Any radius to the lipping must comply with section 5.3.1.

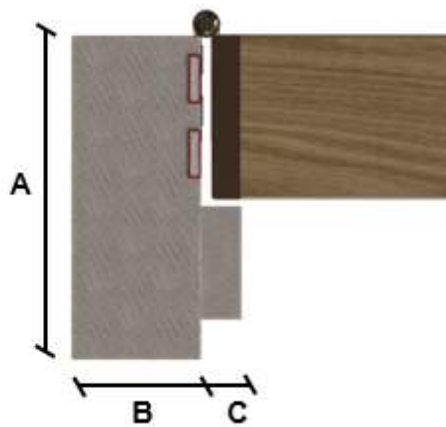

- A: Frame depth = 70mm minimum
- B: Frame width = 30mm minimum
- C: Stop width = 12mm minimum

7.3.1 Scalloped frame detail for double acting doorsets

The diagram below shows detail of the scalloped frame construction hanging edge only. When using scalloped frames for double acting doorsets, the groove for the specified intumescent strips must be as shown below and to the correct depth. Where utilising scalloped frames for double acting doorsets, any radius to the lipping must comply with section 5.3.1 or section 5.3.3.

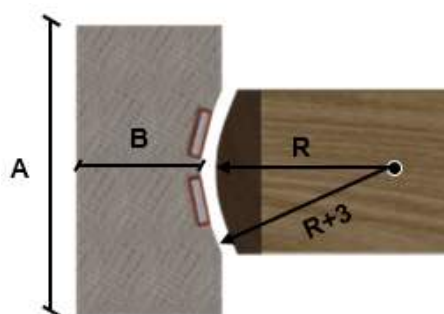

- A: Frame depth = 120mm minimum
- B: Frame width =
 - Jamb: 38mm minimum
 - Head: 68mm minimum
- R: Radius from floor spring or pivot

Each face of the door leaf must be set back from each face of the wall by a minimum of 33mm. i.e from both sides. The face of the leaf must also be a minimum of 33mm from either face of the frame.

7.3.2 Square frame detail for double acting doorsets

The diagram below shows detail of the square frame construction for the closing edge of a double acting doorset. Any radius to the lipping must comply with section 5.3.1 or 5.3.3.

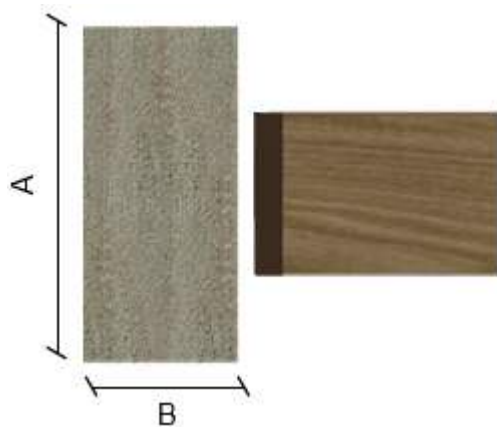

A: Frame depth = 120mm minimum

B: Frame width = 38mm minimum

7.4 Details for Frame 4

The door frame listed below is the minimum size and density which have been successfully tested in test reference CFR2211141 LH and assessed by this report. The frame must be constructed to meet the following specification for single acting frames, where applicable.

Frame specification				
Frame type	Material	Minimum section size (mm)	Minimum density (kg/m ³)	Acceptable leaf type
4	MDF – solid lengths	Frame part 1 (opening side): 70 (d) x 30 (w) (excluding the width of the integral architrave) Frame part 2 (closing side): 62 (d) x 30 (w) (excluding the width of the integral architrave) Stop: 12 (w) x 32 (d) (planted on)	700	Leaf 1
4	Hardwood: (see section 2.1) The use of Beech (<i>Fagus species</i>) is NOT permitted.	Frame part 1 (opening side): 70 (d) x 32 (w) (excluding the width of the integral architrave) Frame part 2 (closing side): 62 (d) x 32 (w) (excluding the width of the integral architrave) Stop: 12 (w) x 32 (d) (planted on)	640	Leaf 1

Note:

The groove for the tongue is 12mm (wide) x 15mm (deep), and the tongue of 12mm (wide x 32mm (deep) must be of the same material and minimum density as the frame. The tongues must run the full length of the frame grooves with tight joints at the top corners of the frames and be adhered with PU wood adhesive as tested.

The stop must span part 1 and part 2 of the frame as tested, therefore if the frame part 1 depth is increased above the minimum dimension then the stop depth must be increased by at least the same amount.

Frame 4 was tested with a 100mm thick supporting construction. Where Frame 4 is used with a wall of greater thickness than 100mm, the total depth of Frame part 1 and/or 2 must be increased accordingly by the increase in wall thickness.

All edges of the leaf must be lipped in accordance with 5.3.1.

The use of shared transomed overpanels is not permitted with Frame 4.

It is not possible to meet the cross-sectional dimensions of the above detailed MDF frame by bonding additional solid lengths.

7.4.1 Standard frame detail

The diagram below shows detail of the standard frame construction. Any radius to the lipping must comply with section 5.3.1.

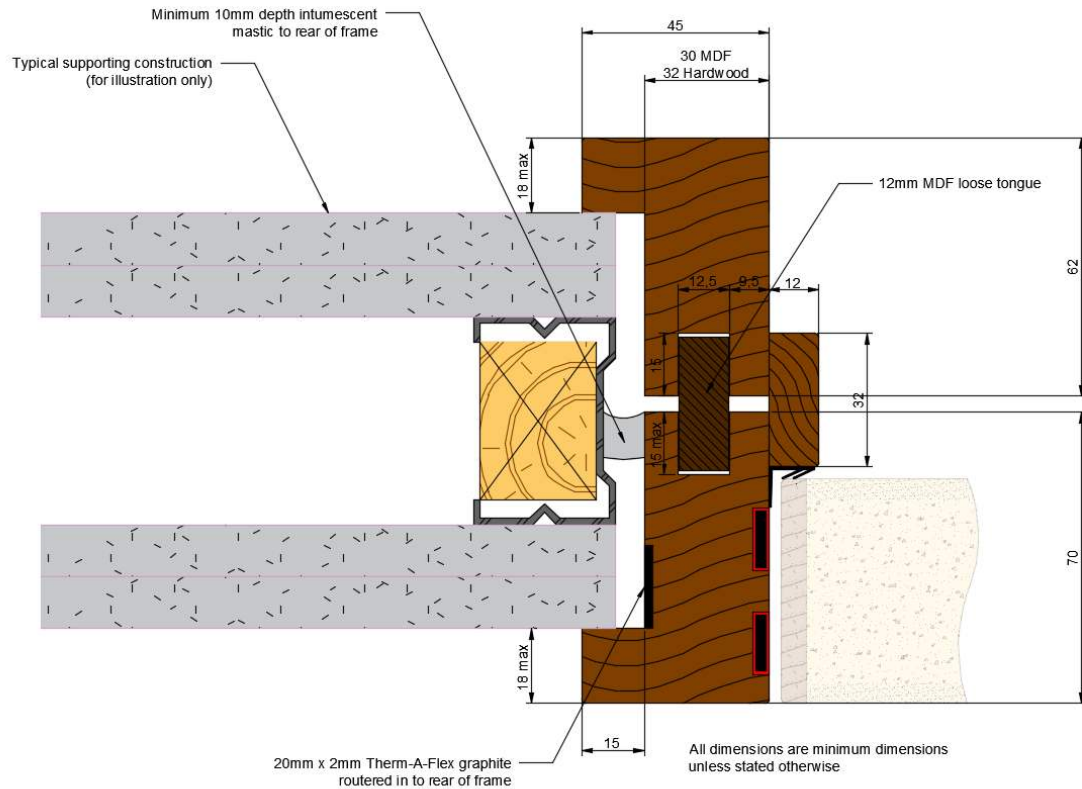

7.5 Details for Frame 5

The door frame listed below is the minimum size and density which has been assessed on the basis of the successful tested CFR2211141 LH. The frame must be constructed to meet the following specification for single acting frames, where applicable.

Frame specification				
Frame type	Material	Minimum section size (mm)	Minimum density (kg/m ³)	Acceptable leaf type
5	MDF – solid lengths	Frame: 70 (d) x 45 (w) (excluding stop) Stop: 12 (w) (integral or planted on)	700	Leaf 1
5	Hardwood: The use of Beech (<i>Fagus species</i>) is NOT permitted.	Frame: 70 (d) x 45 (w) (excluding stop) Stop: 12 (w) (integral or planted on)	640	Leaf 1

Note:

All edges of the leaf must be lipped in accordance with 5.3.1.

The use of shared transomed overpanels is not permitted with Frame 5.

It is not possible to meet the cross-sectional dimensions of the above detailed MDF frame by bonding additional solid lengths.

7.5.1 Standard frame detail

The diagram below shows detail of the standard frame construction with minimum section. Any radius to the lipping must comply with section 5.3.1.

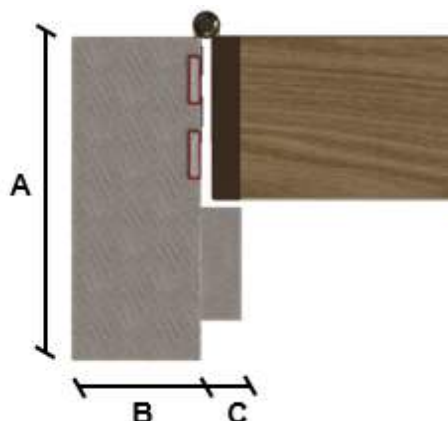

A: Frame depth = 70mm minimum

B: Frame width = 45mm minimum

C: Stop width = 12mm minimum

7.6 Details for Frame 7

This frame type has been successfully tested in test reference BMT/FEP/F16037, BMT/FEP/F14102. Test reference WF420227 has also been considered, with discussion on this in section 4.4.6.

The WoodEx door frame is based on engineered hardwood timber and must be one of the following specifications.

WoodEx Product	Construction Methods			Minimum Density (kg/m ³)	Moisture content
	Finger jointed (see note 1)	Finger jointed and edge glued (see note 2)	3 layer construction (see note 3)		
European Oak	Yes	Yes	Yes	650	12% +/- 2%
Sapele	Yes	Yes	Yes	650	12% +/- 2%

Notes:

1. Finger jointed lamels are glued together and pressed into long blanks.
2. Finger jointed lamels with additional edge glued timber to provide for wider sections and clear faces.
3. Lamels are pressed and glued together with two high quality clear faces (middle layers may be finger jointed). Alternatively, each lamel layer may be finger jointed.
4. Lamels may be 20 – 25mm thick.
5. Timber for door frames must meet or exceed class J30 as specified in BS EN 942: 2007, providing any defects are adequately repaired.

The door frames listed below are the minimum size and density which have been successfully tested and assessed by this report. The frame must be constructed to meet the following specification for single acting frames, where applicable.

Frame specification				
Frame type	Material	Minimum section size (mm)	Minimum density (kg/m ³)	Acceptable leaf type
7	WoodEx European Oak or Sapele ¹	Frame: 70 (d) x 30 (w) (excluding stop) Stop: 15 (w) (integral or planted on)	650	Leaf 1

Note:

- 1) See above for further specification of permitted WoodEx products
- 2) Minimum section size is subject to use of double acting configuration (see frame details below).
- 3) All edges of the leaf must be lipped in accordance with either 5.3.1 or 5.3.4.
- 4) The use of shared transomed overpanels is not permitted with Frame 7.

7.6.1 Standard frame detail

The diagram below shows detail of the standard frame construction. Any radius to the lipping must comply with section 5.3.1.

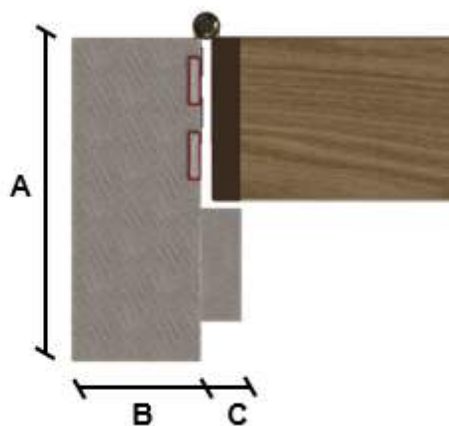

A: Frame depth = 70mm minimum

B: Frame width = 30mm minimum

C: Stop width = 15mm minimum

7.7 4-sided timber frame with door stop – Frame 1

Test reference WF507673 included a Prima 60 double doorset installed into a steel stud partition with the bottom of the doorset at 500mm above the furnace floor. Perimeter failures occurred from 49 minutes which have been attributed to the trialling of an alternative lipping application method, though there were no failures at the bottom of the leaves prior to the test being terminated at 61 minutes. By restricting the leaf size, increasing the leaf head intumescent specification and reducing the height permitted above the furnace floor, it is the opinion of Warringtonfire that this is suitable and sufficient test evidence to support a 4-sided timber frame as detailed below and subject to the following limitations.

A 4-sided timber (hardwood) frame is permitted providing the doorset design complies with the following:

- Frame 1 only, subject to minimum frame width of 32mm with a minimum stop size of 22mm x 12mm, which may be planted (pinned or screwed) or integral.
- Configuration: LSASD, LSADD
- Raised threshold height of no more than 200mm above the finished floor level on either side.
- The permitted leaf height when including a raised threshold is as permitted by sections 4.5.7 and 4.5.12 (Intumescent specifications A/23 and F/23 only) but reduced in line with the height of the raised threshold and the frame width used. This is to ensure the permitted top of the leaf is at no higher a position relative to the finished floor level.
For example, where the bottom of the door frame (of 32mm width) is 200mm above the finished floor level, this will reduce the permitted leaf height by 232mm.
- Required Intumescent seals for frame head, jambs and raised threshold is:
 - 2No. 15mm x 4mm Halspan SLS-PLA seals (PVC encapsulated graphite) positioned centrally and 10mm apart in the frame reveal.
- The permitted height for hardware other than hinges (for example a lock) will be relative to the floor level and not the bottom of the leaf.
- See section 11.7 for maximum gap between the bottom of the door and the threshold.

7.7.1 Drawing of Permitted Raised Timber Threshold with door stop

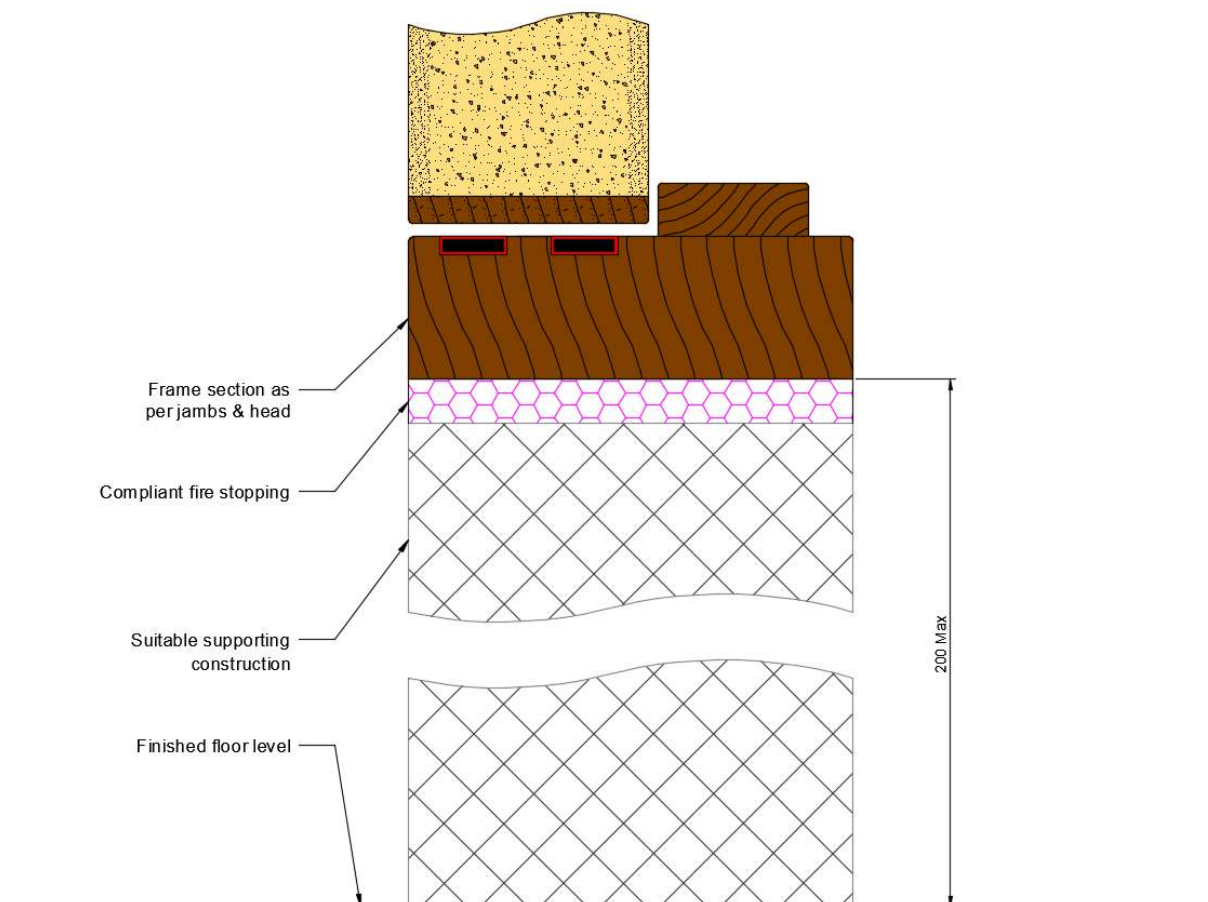

7.8 Hardwood timber threshold without door stop – Frame 1, 2, 3

Test reference CFR2209201 included a Prima 60 single leaf doorset installed with a hardwood threshold, butt jointed to the bottom of the frame jambs. The first failure of the design was at a glazed side light at 56 minutes, however the test is considered to be suitable test evidence to support timber thresholds as the fire resistance performance demonstrated at the leaf perimeter was 68 minutes.

On the basis of the testing, a hardwood timber threshold is suitable to be fitted at floor level in the following applications only:

Frame options: 1, 2, 3

Configuration: LSASD, ULSASD, LSASD+OP, ULSASD+OP, LSADD, ULSADD, LSADD+OP, ULSADD+OP.

In all cases the following scope must be complied with:

- Threshold design:
 - Hardwood (not Beech, *Fagus species*) timber of minimum density 640kg/m³.
 - Depth of 94 to 150mm width x 15 to 32mm thick.
 - Optional chamfers are permitted as long as they are outside of the minimum 94mm width and not located below the leaf thickness.
- The hardwood threshold is butt jointed to the bottom of the frame jambs and fixed with a minimum of 2 screws of minimum length 50mm.
- 2No. 15mm wide x 4mm thick seals must be fitted to the bottom edge of the leaf fitted centrally 10mm apart or spaced either side of the drop seal.
- A rebated threshold drop seal (see section 10.17.2) may be optionally fitted to the bottom edge of the leaf and engaging onto timber threshold.
- See section 11.7 for gap requirements at the bottom of the door.

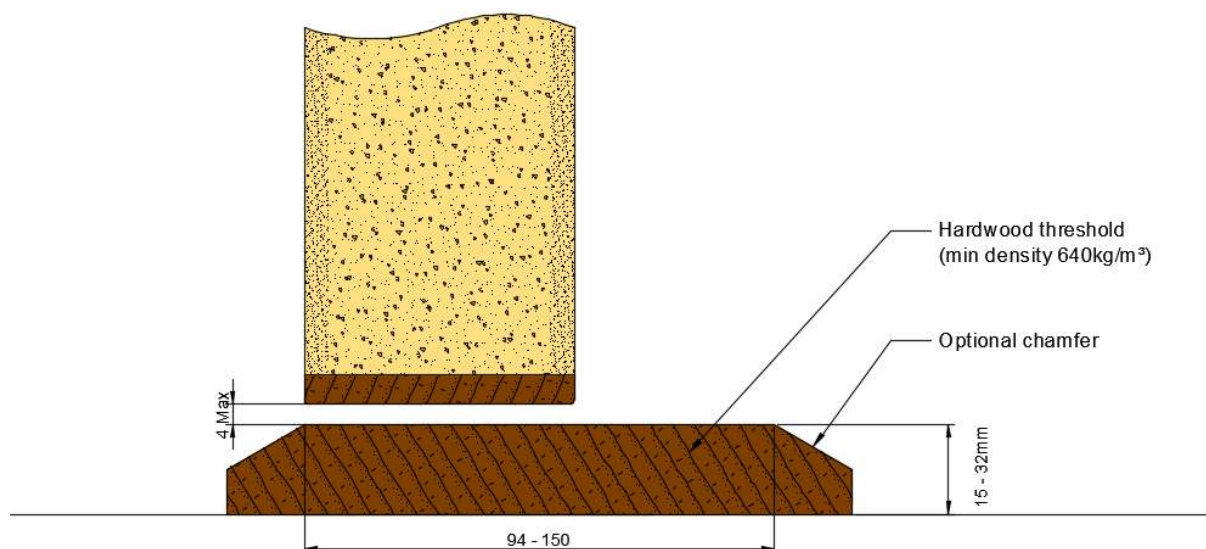

7.9 Aluminium Threshold – Frame 1, 2, 3

The table below details the tested aluminium threshold that is approved to be fitted at floor level below the door leaf, between the frame jambs.

Manufacturer & Product Reference (Test evidence)
<ul style="list-style-type: none">Exitex MDS 25/58 RTIB (CFR2006181, CFR2105131)

On the basis of the testing, the tested aluminium threshold is suitable in the following applications only:

Frame options: 1, 2, 3

Configuration: LSASD

In all cases the following scope must be complied with:

- The threshold must be screwed to the notional floor level with fixings of minimum 25mm long at 250 to 350mm centres. Optionally a bead of acrylic intumescent mastic may be applied in addition to the fixings (though this is not required for fire resistance performance).
- 2No. 15mm wide x 4mm thick Halspan SLS or Pyroplex 8700 seals must be fitted to the bottom edge of the leaf fitted centrally and 10mm apart.
- Threshold drop seals cannot be used when an aluminium threshold is present.
- See section 11.7 for gap requirements at the bottom of the door.

7.10 Door Frame Joints

Below are depictions of the door framing joints that are deemed acceptable for all frame types. Please note that the drawings are provided as general illustrations of each type of door frame joint; actual construction in terms of intumescent seal location and material, etc. must be as the text within this document specifies. The door frame joints are required to be tight, with no gaps, and require mechanical fixing with the appropriate size ring shank nails or screws. Frame joints may additionally be reinforced with any of the adhesives approved for the application of lippings, on the basis that the approved lipping adhesive has been proven to contribute to the positive fire resistance performance of the timber to timber junction at the door leaf edge.



Double Rebated Joint



Mitre Joint



Mortice & Tenon Joint



Butt Joint



Trenched or Half Lapped Joint

Approved door frame jointing options

7.11 Decorative Facings – All Frame Options

Relatively thin facing materials are deemed to be decorative. Their application is not considered to be of detriment to the overall stability or performance of the doorset design.

The following additional facing materials are therefore permitted to the frame for this door design, including frame reveal, since they would have limited influence under fire resistance test conditions.

Decorative & Protective Facing Specification	
Facing Material	Maximum Permitted Thickness (mm)
Paint ³	0.2
Timber veneers	0.7
High Pressure Laminates (HPL) or PVC Vinyl's	0.8

Notes:

1. Facing materials not listed above are not permitted.
2. For all options, materials must not conceal intumescent strips.
3. Intumescent paints are not permitted.
4. Decorative finishes listed above may be painted within the limits for paint finish, above.
5. Decorative facings are to be considered separately from the minimum frame dimensions specified above. I.e. in addition to not make up the minimum frame dimension.

8 Overpanels & Fanlights, Sidepanel & Sidelights

Overpanels, fanlights, sidepanels and sidelights are permitted based on the testing as summarised within section 3, the following sections outline the constructional details of each of the permitted elements and limitations associated with each configuration.

8.1 General

The testing undertaken on the Prima 60 doorset design allows for the application of:

Solid overpanels with three framing options (Modular, Transomed & Flush).

Solid sidepanels with one framing option (Modular).

Glazed fanlights with one framing option (Modular).

Glazed sidelights with one framing option (Modular).

Framing options are detailed in the following section depending on the panel or glazing utilised.

It is possible to utilise both methods of framing within any single doorset design providing the restrictions given in the following sections are adhered to. i.e. it is possible to provide a doorset with a solid overpanel separated by a shared transom with a modular framed sidelight beside it.

In all cases the overall dimensions permitted for a Prima 60 doorset design that includes fanlights, sidepanels and / or sidelights shall not exceed 2950mm high x 4800mm wide.

Where modular framing is utilised, only one module may be fitted above the door frame height.

8.2 Framing

The following framing options as detailed below are permitted for the Prima 60 doorset design and are permitted depending on solid panel arrangement or glazed fanlight / sidelight utilised. Information on the frame type permitted for the solid panel or glazed element is detailed in sections 8.2.1 – 8.2.3.

8.2.1 Modular Framing

Modular framing for the purpose of this document is considered to be an element (glazing or panel) which is independently framed and fixed to the frame of a doorset design. An example of a modular framed solution is given below. This is supported for use in this assessment by test CFR2203091.



Single leaf doorset with glazed modular sidelight.

8.2.1.1 Standard Frame Detail (Modular Framing)

The frame listed below is the minimum size and density which has been successfully tested and assessed by this report. The frame must be constructed to meet the following specification for modular units containing solid panels or glazing, the frame section shall meet this specification on all four edges.

Modular Frame specification		
Material	Minimum section size (mm)	Minimum density (kg/m ³)
Hardwood: (see section 2.1) The use of Beech (<i>Fagus species</i>) is NOT permitted.	Frame: 94 (d) x 32 (w)	640

Standard Stopped Frame Detail
 (modular framing)

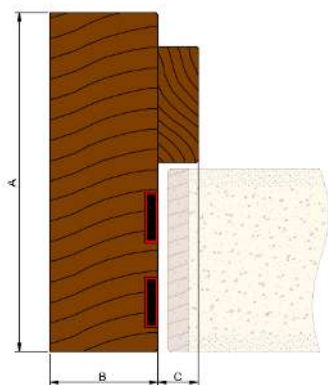

Standard Rebated Frame Detail
 (modular framing)

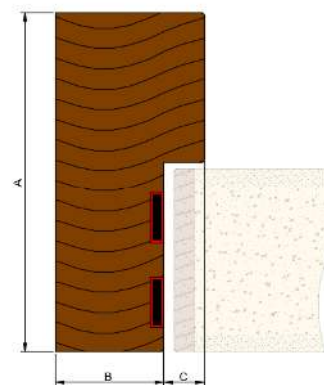

A: Frame depth = 94mm minimum
 B: Frame width = 32mm minimum
 C: Stop width = 12mm minimum

Notes:

It is possible to include a 3mm x 3mm quirk detail to the rear edges of the frame where the jointing to the door frame or adjacent modular framing element shall occur.

The depth of the modular frame and the door frame shall be equal, this may result in increasing the depth of the permitted door frame to match the modular frame dimension, or vice versa. In all cases the greater dimension shall be used.

8.2.1.2 Transom or Mullion Detail (Modular Framing)

It is possible to include a single transom within a modular unit applied to the side of a doorset and / or a single mullion within a modular unit applied to the head of a doorset.

When applied the transom or mullion shall meet the following specification:

Modular Frame specification		
Material	Minimum section size (mm)	Minimum density (kg/m ³)
Hardwood: (see section 2.1) The use of Beech (<i>Fagus species</i>) is NOT permitted.	Frame: 94 (d) x 32 (w)	640

The transom or mullion when applied shall be mortice and tenon jointed as depicted in section 8.2.1.3. The joints are required to be tight, with no gaps, and require mechanical fixing with 2No. Ø5 x 80mm steel screws.

Standard Stopped Transom/Mullion Detail
 (modular framing)

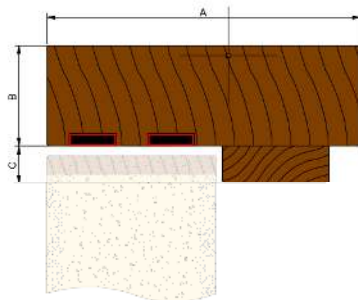

Standard Rebated Transom/Mullion Detail
 (modular framing)

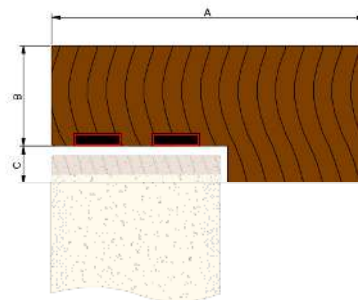

- A: Frame depth = 94mm minimum
- B: Frame width = 32mm minimum
- C: Stop width = 12mm minimum

Transoms when applied shall not be greater than 1000mm from the centre of the transom to the notional floor level. This may inhibit the use of transoms in some configurations.

Mullions shall not be applied in modular sidepanels or sidelights.

It is possible to include solid panel and glazing arrangements which are permitted as detailed in section 8.3 and 8.4 either side of a transom within a modular unit applied to the side of a doorset subject to the positioning requirement of the transom given above and the maximum permitted glass or panel size given in the following sections.

8.2.1.3 Frame Jointing (Modular Framing)

Below are depictions of the framing joints that are deemed acceptable for corner jointing of modular framing. Please note that the drawings are provided as general illustrations of each type of frame joint; actual construction in terms of intumescent seal location and material, etc. must be as the text within this document specifies.



Double Rebated Joint



Mitre Joint



Mortice & Tenon Joint



Butt Joint



Trenched or Half Lapped Joint

The modular frame joints are required to be tight, with no gaps, and require mechanical fixing with 2No. Ø5 x 80mm steel screws. Frame joints shall additionally be reinforced with the adhesives approved for the application frame jointing detailed within section 9.

8.2.1.4 Attachment Technique (Modular Framing)

The modular framing must be affixed to the door frame or adjacent modular framed units utilising steel screws appropriate for use with timber substrates.

Screws must be fixed between 100mm and 150mm from corners at maximum of 600mm centres from each face. Fixings shall penetrate approximately half of the depth of the adjacent timber section.

Additionally, a 20mm wide x 6mm thick MDF “Loose Tongue” shall be positioned centrally within the jointed element and bonded to both frame members with PU or PVA adhesive.

A visual representation of the permitted jointing method is detailed below:

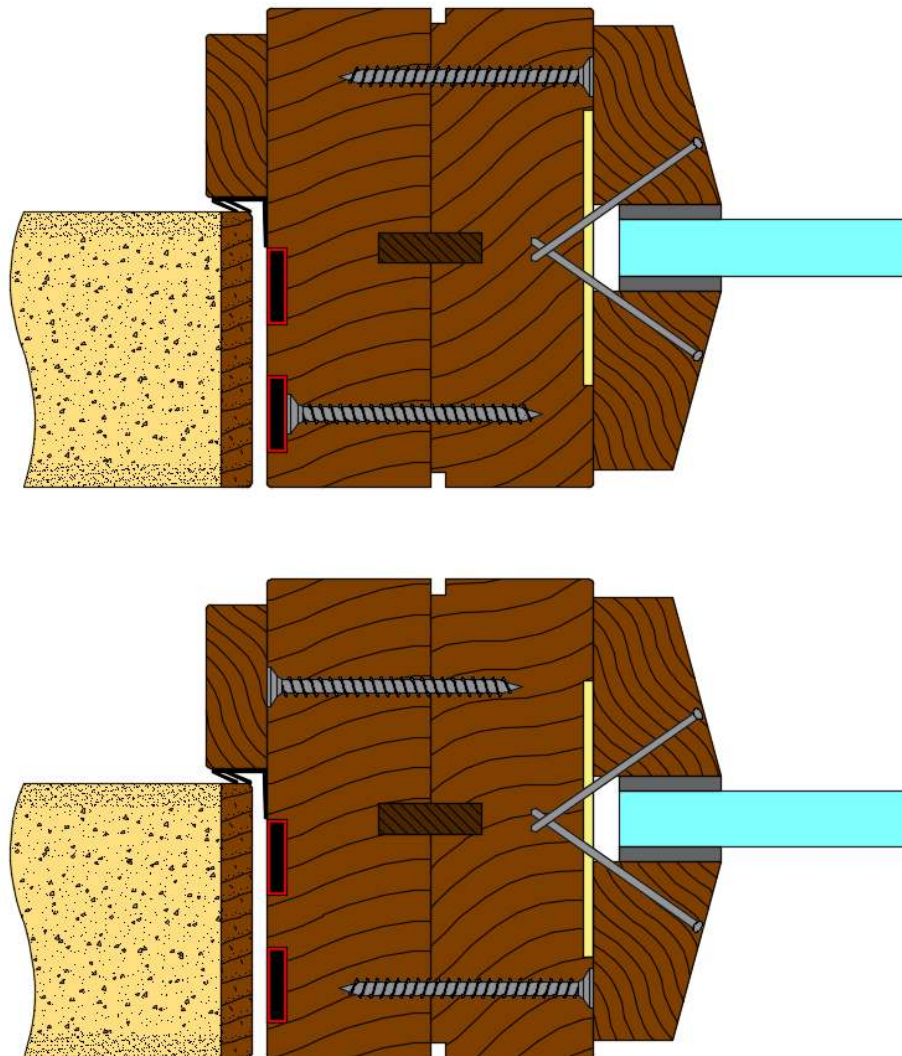

8.2.1.5 Bottom Rail Detail (Modular Framing)

Based on the testing as summarised in section 3, specifically CFR2209201 the following bottom rail detail is permitted for use between the bottom edge of the modular frame and the floor level.

The bottom rail must be constructed as follows:

Element	Material	Dimensions (mm)	Minimum Density (kg/m ³)
Core	Halspan Prima 3 layer solid core particleboard	64 (t)	630±10%
Facing	MDF	15 (t)	700
Facing Adhesive	PU or PVA		

The facing material may optionally include a 3mm x 3mm quirk detail adjacent to the modular frame as shown.

The maximum height of the bottom rail permitted herein is 100mm.

When applied the vertical jambs of the modular unit will encase the detailed bottom rail (i.e. run to the floor level). A single 70mm long steel screw shall be applied centrally through the rear of each of the modular frame jambs into the 64mm core area.

When applied the bottom rail shall be bedded on a nominally 6mm bead of intumescent mastic. Gaps between the floor level and the bottom edge of the bottom rail shall be no greater than 2mm or additional fire stopping materials as detailed within section 11.3 must be applied.

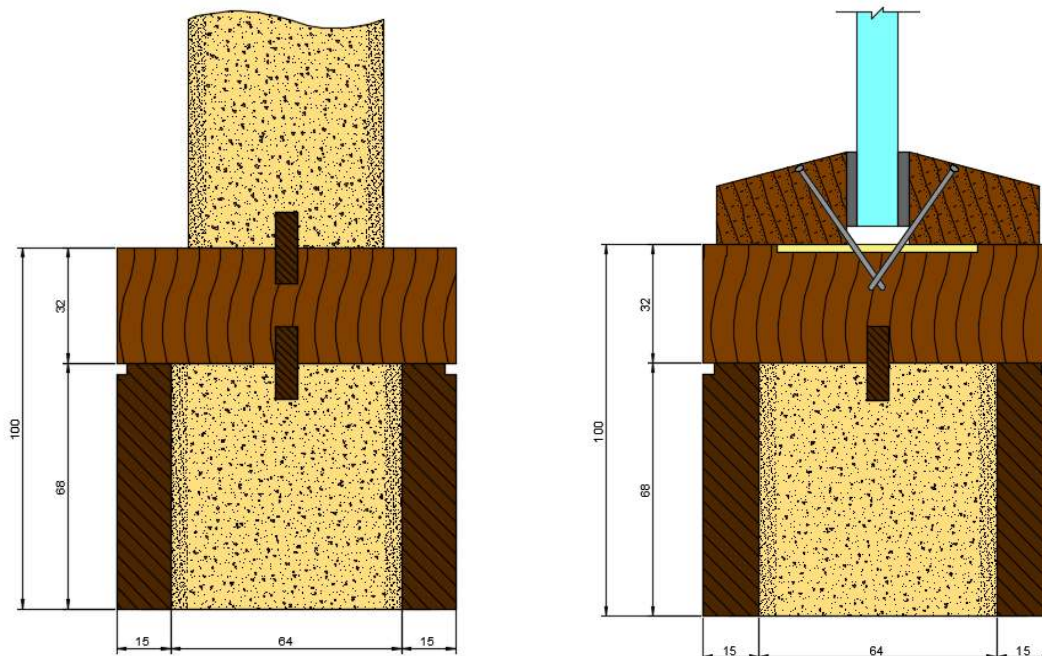

8.2.2 Shared framing (Transomed)

Shared framing (Transomed) for the purpose of this document is considered to be when an element (panel) is contained within the frame for the doorset and separated from the door leaf by a shared transom. An example of a transomed solution is given below, though the construction of doorsets shall be as the text in this document specifies.



8.2.2.1 Standard Frame Detail (Transomed)

The permitted frame detail for the doorset shall meet the minimum requirements as outlined in section 7, where applicable. The detail for the permitted transom can be found within section 8.2.2.2 below.

8.2.2.2 Detail for Transom (Transomed)

It is possible to include a transom to separate a panelled overpanel within a door frame from the door leaf. It is not permitted to include a mullion within a doorset which is constructed using the shared framing design. When applied the transom shall meet the following specification:

Transomed Frame specification		
Frame Type	Minimum section size (mm)	Minimum density (kg/m ³)
Frame 1	Transom: 70 (d) x 44 (w)	640
Frame 2	Not Permitted	
Frame 3		
Frame 4		
Frame 5		
Frame 7		

Notes:

When applied the material for the transom shall match the timber species used for the frame surrounding the door frame.

The transom when applied shall be mortice and tenon or butt jointed as depicted in section 8.2.2.3. The joints are required to be tight, with no gaps, and require mechanical fixing with 2No. Ø5 x 80mm steel screws.

Standard Stopped Transom Detail

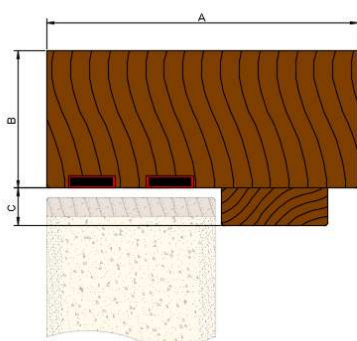

Standard Rebated Transom Detail

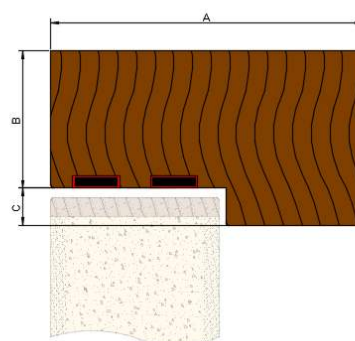

A: Frame depth = 70mm minimum
 B: Frame width = 44mm minimum
 C: Stop width = 12mm minimum

8.2.2.3 Frame Jointing (Transomed)

The framing joints that are deemed acceptable for corner jointing of transomed framing are:

- Mortice & Tenon
- Butt Jointing
- Trench Jointing (When this method is utilised the trench must be limited to no greater than 50% of the trenched element)

The transom when applied must be jointed as detailed above. The joints are required to be tight, with no gaps, and require mechanical fixing with 2No. Ø5 x 80mm steel screws. The joints may be additionally adhered with PU or PVA adhesive.

8.2.3 Flush Overpanels

Based on the testing undertaken on the Prima 60 doorset design it is possible to include solid flush overpanels.

A flush overpanel is where a solid over panel has been included within the door frame and has no additional separating element between the panel and the door leaf or leaves.

Examples of the junction between the head of the leaf and a flush overpanel are given overleaf.

Flush overpanels where permitted are detailed within the permitted leaf configurations and require specific perimeter intumescent specifications, these are found within sections 4.5.10, 4.5.11, 4.5.15 & 4.5.16.

Examples of Flush Overpanel Arrangements

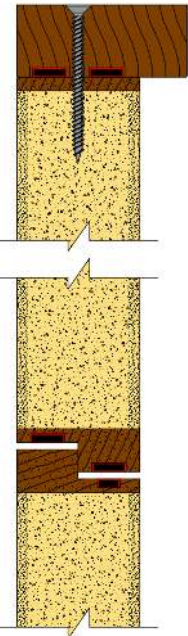
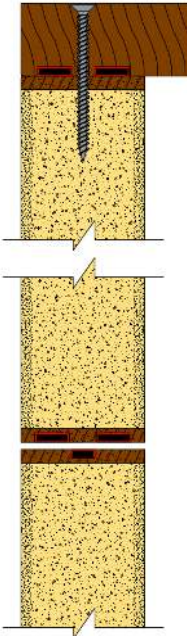
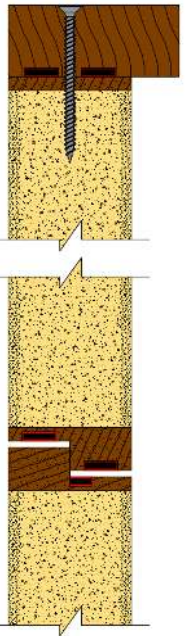
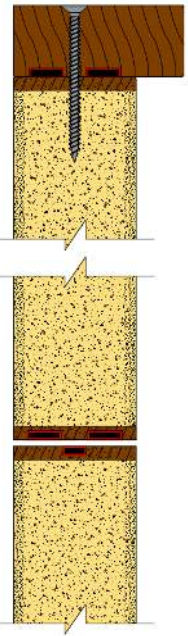
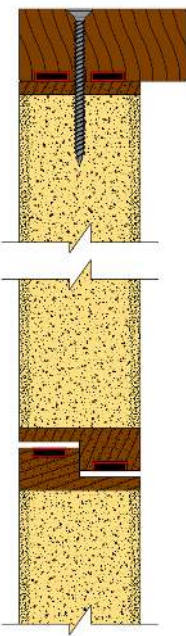
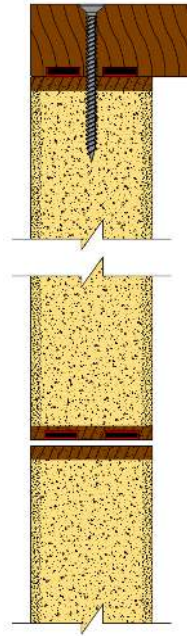
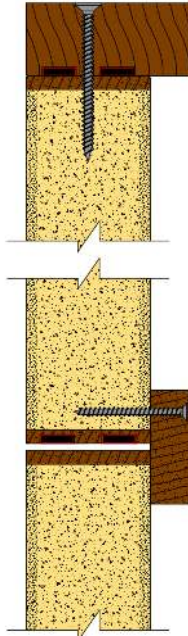
						
C/7 & D/7 Option A	C/7 & D/7 Option B	C/9, D/9, H/9 & I/9 Option A	C/9, D/9, H/9 & I/9 Option B	C/19, D/19, H/19 & I/19 Option A	C/19, D/19, H/19 & I/19 Option B	Astragal example

8.3 Solid Panels

Solid side and overpanels are permitted for use with the modular framing option given in section 8.2.1 above (Modular Framing).

Solid overpanels are also permitted for use with the shared framing option given in section 8.2.2 above. (Shared Framing (Transomed)).

Solid overpanels are also permitted for use as a flush over panel given in section 8.2.3 above, subject to meeting the requirements outlined within sections 4.5.10, 4.5.11, 4.5.15 & 4.5.16 which detail the required intumescent specification.

8.3.1 Solid Panel Construction (Side or Over Panels)

Based on the testing undertaken on the Prima 60 doorset design, it has been assessed to include the tested core construction as a solid fixed panel. This is because under test conditions the panel will be fixed within the perimeter framing limiting the deflection throughout the test duration and enhancing the expected fire resistance performance which was observed for the door leaf itself. Therefore, the following specification shall be met:

Element	Material	Dimensions (mm)	Minimum Density (kg/m ³)
Core	Halspan Prima 3 layer solid core particleboard	54 (t)	630±10%

The panel may be lipped as specified in section 5.3.1 or 5.3.3 as applicable for intumescent specification detailed in section 4.5, and the panel shall be constructed of a single board, joints are not permitted within any panels.

The minimum panel thickness after calibration is 53mm (i.e. a maximum of 0.5mm from both sides).

Decorative & protective facings may be applied to the surface of the solid panels in accordance with section 5.5.

The minimum panel thickness after finishes applied is 54mm.

8.3.2 Intumescent Sealing Arrangement (Side or Over Panels)

Solid side and overpanels when included within a doorset design (in either modular or shared framing) shall include the same intumescent specification as utilised within the door leaf or frame reveal.

Alternatively, for applications below 1m height from the notional floor level, as supported by CFR2209201, where the panel is installed within a modular framing option in a side panel arrangement, with the panel positioned centrally within the depth of the frame, it is permitted to apply: (as depicted below)

- SLS-GLZ-113 liner, 54mm (w) x 2 (t) rebated to flush within the vertical frame elements and,
- 20mm (w) x 6mm (t) Loose MDF tongue applied centrally to the thickness of the panel across the horizontal edges, bonded with PU or PVA adhesive.

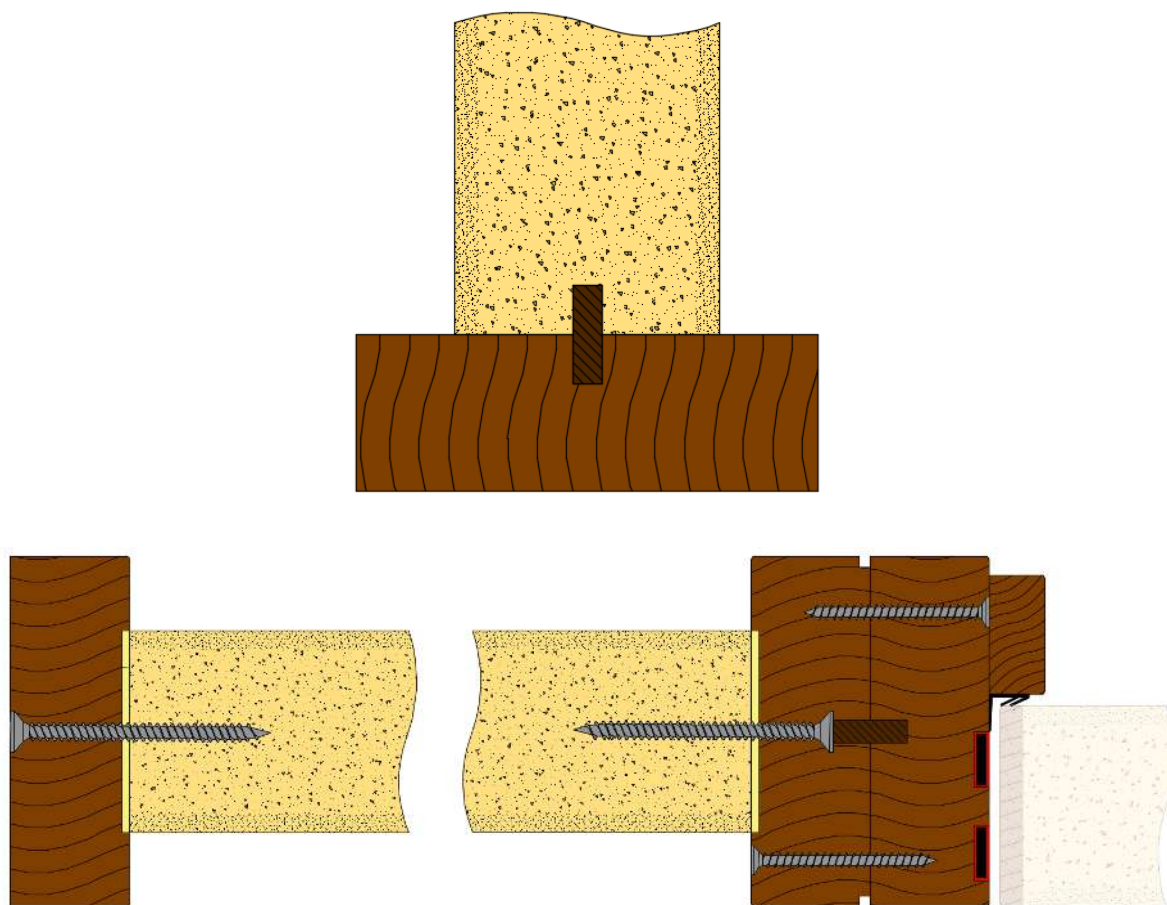

Solid flush overpanels shall include the intumescent specification as detailed within sections 4.5.10, 4.5.11, 4.5.15 & 4.5.16 as applicable.

Permitted intumescent specifications are detailed in section 4.5, while there may be multiple options for manufacturer and seal types only one specification can be utilised with any single doorset, and the specification used shall match the specification used on the door leaf.

8.3.3 Fixing Arrangement (Side or Overpanels)

Solid panels must be fixed into the framing solution by steel screws appropriate for the timber-based substrates.

Screws shall be applied nominally centrally to the thickness of the solid panel, through the rear of the frame to all edges and transom reveal where applicable and shall penetrate into the solid panel by at least 38mm as tested.

Fixings must be no more than 100mm from each corner and a maximum of 350mm centres in between.

When fitted the solid panel shall have no greater than 1mm between the panel edge and the adjacent framing element.

Where fitted within shared framing (transomed) the face of the solid overpanel shall be nominally in line with the face of the door leaf.

Where fitted within modular framing the panel may either be nominally in line with the face of the door leaf or centrally within the modular frame depth.

Where fitted in a flush arrangement the face of the solid overpanel shall be in line with the face of the door leaf.

Beading or cover mouldings up to 50mm wide x 50mm deep, may be freely applied to either face of the joint of the solid panel to the framing section, beading or cover moulding material must be the same specification as the frame material.

8.3.4 Maximum Dimensions (Side or Overpanels)

Based on the testing undertaken within the Prima 60 doorset design the following maximum dimensions are permitted for any single panel, subject to the doorset not exceeding 4800mm in width including outer framing dimensions.

Solid Panel & Frame Type	Height (mm)	Width (mm)
Flush Overpanel	621	Overall doorset width
Overpanel (Shared Framing)	Up to 1500 for double doorset configurations and 2000 for single doorset configurations.	
Overpanel (Modular Framing)		
Sidepanel (Modular Framing)	Up to maximum dimension given in section 4.5 for leaf size based on intumescent specification used. Or When using SLS-GLZ-113 option provided within section 8.3.2 no greater than 1000mm.	Up to maximum dimension given in section 4.5 for leaf size based on intumescent specification used. Or When using SLS-GLZ-113 option provided within section 8.3.2 no greater than 800mm.

The overall assembly shall form a rectilinear shape.

8.4 Glazed Fanlights & Sidelights

Based on the testing detailed within section 3, it has been possible to consider the use of glazed fanlights and sidelights with the modular framing given in section 8.2.1 above.

The glazing system must be one of the following tested or assessed glass types and glazing systems. Alternatively, it is possible to utilise glass and glazing systems with a Certifire certificate – Valid at the date of manufacture of the doorset which has been written in accordance with Warringtonfire Testing and Certification Ltd Technical Schedule 25. More information on the use of Certifire approved glass and glazing systems can be found within section 8.4.2.

8.4.1 Tested and Assessed Glass types & Glazing Systems

The table below specifies the maximum assessed height and width that is deemed acceptable for different aspect ratios ('landscape' or 'portrait' orientation) for an individual glazed aperture, based upon the test evidence contained within section 3.

The dimensions of any single glazed aperture must not exceed that stated below, nor shall the entire assembly exceed 4800mm wide x 2950mm high for any individual doorset including the dimension of the door frame, fanlights, sidepanels and sidelights.

Note: sidelights including a horizontal transom separating two glass panes are to be considered as two apertures for the purpose of the maximum pane dimensions given below, Therefore, each aperture must individually comply with the relevant maximum pane dimensions.

Test Reference	Glass Type	Perimeter Frame (w x t) mm	Frame Density (kg/m ³)	Transom / Mullion (w x t) mm	Maximum Pane Dimensions (mm)	Max Glazed Area (m ²)	Glazing System	Glazing Bead Size		Bead Shape	Bead: Density (kg/m ³)	Bead Fixing
								Height	Width			
RF05036	Pilkington Pyrodur 60-10 (10mm thick)	95 x 45	640	95 x 45	Landscape: 915 (h) x 1237 (w) Portrait: 2400 (h) x 1054 (w)	Landscape: 0.98 Portrait: 2.19	Hodgesons Sealant Firestrip 60 20mm (w) x 3 (t) fitted between glass and the bead.	20	40	Square or Splayed (15 degrees)	Hardwood (Excluding Beech) 640	Steel screws 60mm long Fitted 50mm long at 150mm centres. 45 degrees to the face of the glass.
CFR2203091	Pyroguard EI30 (INT) – 1(B)1 – 38dB (15mm thick)	100 x 32	640	100 x 44	Landscape: 663 (h) x 1983 (w) Portrait: 2478 (h) x 423 (w)	Landscape: 1.14 Portrait: 0.91	Halspan Limited SLS-GLZ-113 Intumescent Liner 54mm (w) x 2mm (t) fitted lining the aperture. (note 3) Halspan Limited SLS-GLZ-112 Glazing Tape 20mm (w) x 5 (t) fitted between glass and the bead.	25	35	Square or Splayed (15 degrees)	Hardwood (Excluding Beech) 640	16swg x 50mm long pneumatically fired pins Fitted 50mm long at 150mm centres. 35 degrees to the face of the glass.

Test Reference	Glass Type	Perimeter Frame (w x t) mm	Frame Density (kg/m ³)	Transom / Mullion (w x t) mm	Maximum Pane Dimensions (mm)	Max Glazed Area (m ²)	Glazing System	Glazing Bead Size		Bead Shape	Bead: Density (kg/m ³)	Bead Fixing
								Height	Width			
WF523941/R (See note 2)	Pyroguard Pyroguard Advance 2- EW60/11-2 (11mm thick)	100 x 32	640	100 x 44	Landscape: 675 (h) x 1993 (w) Portrait: 2488 (h) x 435 (w)	Landscape: 1.16 Portrait: 0.94	Halspan Limited SLS-GLZ-113 Intumescent Liner 54mm (w) x 2mm (t) fitted lining the aperture. (note 3) Halspan Limited SLS-GLZ-112 Glazing Tape 20mm (w) x 5 (t) fitted between glass and the bead.	25	35	Square or Splayed (15 degrees)	Hardwood (Excluding Beech) 640	16swg x 50mm long pneumatically fired pins. Fitted 50mm long at 150mm centres. 35 degrees to the face of the glass. & PU adhesive

Notes:

1. Further information on beading is found in section 8.4.1.1 below.
2. The testing undertaken resulted in a failure prior to 60 minutes by means of a cotton pad test. The test undertaken was to EN 1634-1 which requires the application of a cotton pad. Method 8 of BS 476-22 would not permit the application of the cotton pad as was undertaken within the test upon the glass, which is non-insulating, therefore this test supports the use of the glass and glazing system within this assessment.
3. The glazing liner must be rebated within the framing of the glazed element such that it finishes flush.

8.4.1.1 Glazing Beads & Installations

The following sections provide visual representation of the permitted glazing beads, these sections are to be read in conjunction with the table in section 8.4.1 which provides the relevant information relative to the tables below.

8.4.1.1.1 Chamfered Bead (Splayed)

Permitted with glass types from the table in Section 8.4.1 as identified and must be used with the specified glazing system in the table

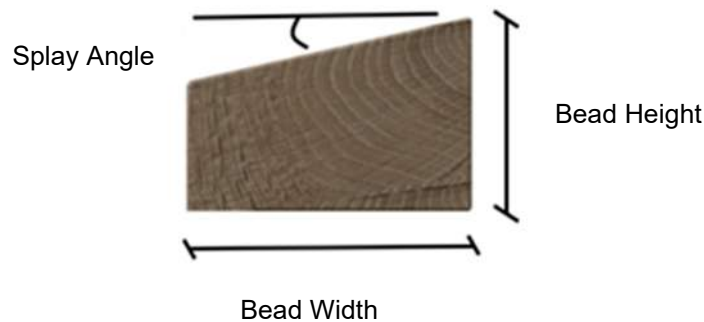

- The glazing beads must be created from hardwood (not Beech *fagus species*). Refer to Section 8.4.1 for the required density for each system.
- Fixings requirements are identified in Section 8.4.1 for each glass & glazing system.
- The fitting of the glazing seal between the bead and the glass should be in accordance with the manufacturer's instructions.
- Glass shall be aligned within the aperture using hardwood or non-combustible setting blocks placed at the bottom horizontal edge only, sized to provide edge cover and expansion allowance as the specific system requires

8.4.1.1.2 Square Bead

Permitted with glass types from the table in Section 8.4.1 as identified and must be used with the specified glazing system in the table

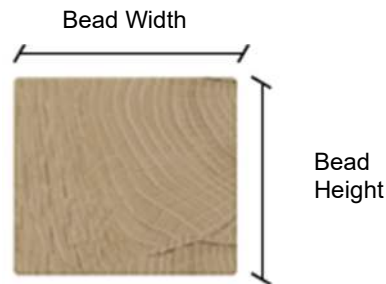

- The glazing beads must be created from hardwood (not Beech *fagus species*). Refer to Section 8.4.1 for the required density for each system.
- Fixings requirements are identified in Section 8.4.1 for each glass & glazing system.
- The fitting of the glazing seal between the bead and the glass should be in accordance with the manufacturer's instructions.
- Glass shall be aligned within the aperture using hardwood or non-combustible setting blocks placed at the bottom horizontal edge only, sized to provide edge cover and expansion allowance as the specific system requires

8.4.1.1.3 Pin Fixings

Where it is identified within section 8.4.1 that pin fixings are permitted the following pin specification is permitted and has been considered suitable for applications requiring a pin fixing to glazing beads:

Option 1 – Round, Oval & Rectangular Pins

The following dimension of pin has been approved for round, oval and rectangular shaped pins which are hand applied:

- Minimum Standard Wire Gauge (SWG) 16.
- Minimum cross section area of 2.03mm².
- Minimum linear dimension of 1.6mm in any direction, see figure below.



Option 2 – Gun (Pneumatically) Fired Rectangular Pins

The following dimension of rectangular pin has been deemed suitable for gun (pneumatically) fired applications.

- Minimum Standard Wire Gauge (SWG) 16.
- Minimum cross section area of 2.24mm².
- Minimum linear dimensions as shown in the figure.
- The 1.6mm dimension is predominately oriented perpendicular to the glass, where possible.

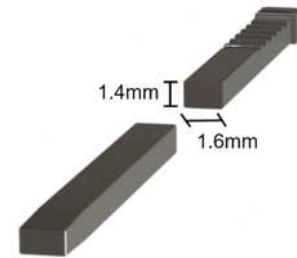

Pins with dimensions less than those stated above are not covered by this assessment.

8.4.2 Certifire Approved Glass & Glazing Systems

Alternative glass and glazing systems with a Certifire certificate – valid at the date of manufacture of the doorset which has been written in accordance with Warringtonfire Testing & Certification Ltd Technical Schedule TS25 - may be utilised to glaze fanlights and sidelights for use with the Prima 60 door design, subject to the following.

- The chosen Certifire approved glass and glazing system must detail that it is suitable for use for 60 minutes fire resistance performance within a timber screen.
- Certifire approved glass and glazing systems may be utilised with the Prima 60 doorset design providing they are able to be applied in a self-contained modular frame.
- The modular frame must meet or exceed the specification for modular frames given within section 8.2.1 above, however, must be fixed to the doorset or adjacent modules in the manner specified in section 8.2.1.4.
- Where a Certifire certificate is utilised to justify fanlights and / or sidelights, the full requirements given within that certificate for the frame (which may require an increase in dimensional requirements given in section 8.2.1 for example), glass type, glazing system and glass retention method specified must be complied with.
- Parameters in section 8.4.1 above relating to the overall dimension of the doorset design including fanlight and sidelight modules must not be exceeded.
- Bead Fixings - The required pin or screw specification as given in the supporting Certifire certificate must be used, alternatives fixing details are not permitted.
- The doorset assembly must remain rectilinear.

9 Adhesives

The following adhesives must be used in the construction of the doorsets. These may be hand applied or may be applied using an edgebander. With either method it must be ensured that sufficient glue is applied across the entire surface area between the 2No substrates being adhered to guarantee a robust bond. Other manufacturers guidance should be followed, for either installation application used.

Element	Product/Material Type
Door blank core	As per manufacturers tested specification.
Timber lipping	UF, PU or hotmelt or PUR
Feature Groove Inserts	UF, PU or PVA
PVC lipping	PU, PUR hotmelt and contact adhesive
Decorative & protective facings	UF, PF, PU, PVA, PVAc or contact adhesive (see note below)
Frame Jointing (Horizontal to Vertical Members)	PU or PVA
Modular Frame Jointing	PU or PVA

Note:

Contact adhesive has been permitted as an acceptable adhesive for decorative facings as the outer decorative & protective facings will have negligible effect on the stability of the door leaf and will be rapidly consumed in fire test conditions.

10 Hardware

10.1 General

The following section details the permitted scope and constraints for fitting hardware to this door design. The following items of hardware must also bear the UKCA or CE Mark in addition to the requirements outlined in the following sections. The UKCA or CE mark must indicate that the hardware is suitable for fire doors in the classification code and declaration of performance issued by the hardware manufacturer:

- Latches & locks: Test Standard EN 12209
- Single axis hinges: Test Standard EN 1935
- Controlled door closing devices: Test Standard EN 1154
- Electrically powered hold-open devices: Test Standard EN 1155
- Door co-ordinators: Test Standard EN 1158
- Emergency exit hardware: Test Standard EN 179
- Panic exit hardware: Test Standard EN 1125.

The following sections consider what tested and assessed alternative items of essential and non-essential hardware that may be used on the doorset range.

Items of hardware have been considered and approved via the following means:

- The component has been successfully tested to BS 476: Part 22: 1987 or BS EN 1634-1 in a suitably similar type of doorset e.g. timber leaf in timber frame.
- As a result of an assessment of the appropriateness of the item of hardware, based on test evidence not commissioned by Halspan Limited.
- As a result of the Certifire approval of the item of hardware – Valid at the date of manufacture.

Each section will consider the named item of hardware and detail if there are any limitations associated with:

- Leaf size
- Configuration
- Intumescent seals
- Intumescent protection
- Frame configuration requirements

Hardware that is either morticed in or includes a through component or fixing may not be within 200mm of another item of hardware unless there is test evidence to demonstrate they can be in closer proximity.

Hardware items should generally be fitted in accordance with the manufacturer's instructions. **However, the parameters and requirements of this assessment always take precedence, including specified protection such as hardware gaskets.** Referenced Certifire approved hardware may be incorporated subject to the design, material and dimensional limitations identified within this assessment report and identified on the relevant Certifire certificate.

Where maximum leaf dimensions are given in the specifications for items of hardware the guidance in section 4.5.5 must be followed.

10.2 Intumescent to Hardware

The intumescent materials used to protect hardware that have been tested and assessed for this doorset design are detailed below. Note that any one of the product/matrix options listed in the table may be used in the specific application noted. However, only 1 manufacturer should be considered for any single item of hardware. For specific items of hardware the intumescent requirements are detailed within the relevant subsection.

The door gap perimeter intumescent seal specifications are documented in conjunction with the leaf envelope size limitations in section 4.

Hardware Intumescent Specification		
Item	Location	Product/Manufacturer (mm)
Butt Hinges	Fitted under each hinge blade.	1 (t) Halspan Limited SLS-PAD-103 graphite (WF512409) 1 (t) Interdens® (WF198681) 2 (t) Interdens® (WF508668) 1 (t) Lorient Polyproducts Ltd, MAP (RF07141) 1 (t) Sealed Tight Solutions Ltd, Graphite, (ST100 x 25) (PF15163)
Single Point Lock/latches and Roller catches	Under forend, keep and encasing lock or latch body for all doorsets	1 (t) Halspan Limited SLS-PAD-109 (CFR1909241) 1 (t) Interdens® (WF379041) 1 (t) Lorient Polyproducts Ltd, MAP (FRR-2008/5506) 2 (t) Lorient Polyproducts Ltd, MAP (FRR-2110/1497 A/B) 1 (t) Sealed Tight Solutions Ltd, Graphite (PF15163)
Flush bolts	Encasing the entire body of the flush bolt including the back surface of the face plate	2 (t) Halspan Limited SLS-PAD112 (WF526042) 2 (t) FlexiFire Z1F0160G graphite (CFR1909241 B) 2 (t) Therm-A-Strip - Intumescent seals Ltd (RF13167) 2 (t) Interdens® (F14095) 2 (t) Lorient MAP (FRR-2110/1498) 1 (t) Lorient MAP (FRR-2102/4628A) 1 (t) Interdens® (F16037) 1 (t) Sealed Tight Solutions Ltd, Graphite (PF15035)

Hardware Intumescent Specification		
Item	Location	Product/Manufacturer (mm)
Rebated threshold drop seals (when required – see section 10.16.2)	Encasing the concealed faces of the drop seal	1 (t) Halspan, Graphite (RF13167) 1 (t) Eurolever MAP XX8002DDS (FRR-2010/2942) 2 (t) Lorient MAP (FRR-2110/1497) 1 (t) Lorient MAP (WB112-1B & 2B)

Note: Halspan intumescent protection is supplied with Halspan hardware, e.g. Halspan sashlock LCK-BSS-104 comes with SLS-PAD-109. The combined product is then referenced BOM-LCK-111.



Example of hinge protection detail



Example of lock & latch protection detail



Example Flush bolt installation and intumescent protection

Gaskets must be fitted where required by supporting evidence, for example, test evidence or Certifire certificates. If gaskets are not required by the supporting evidence but are within this Field of Application, the requirements of this Field of Application take precedence.

Where it is stated that intumescent is not required for a particular element of hardware, it is permitted to use up to 2mm thick MAP, Interdens or graphite-based gasket tested for the particular application as appropriate for the hardware. It is the opinion of Warringtonfire that the additional protection will not detract from the fire resistance performance under test conditions.

10.3 Essential Hardware

The following table details the essential hardware for the various doorset configurations that are referenced in this assessment. Other items of hardware which are detailed within this report may be fitted in addition to the essential items as required for the selected configuration.

Configuration	Hardware
LSASD	<ul style="list-style-type: none"> • Latch • Handle • Hinges • Self-closing device (closer)
ULSASD	<ul style="list-style-type: none"> • Hinges • Self-closing device (closer)
DASD	<ul style="list-style-type: none"> • Top pivot & bottom strap • Self-closing device (closer)
LSASD+OP	<ul style="list-style-type: none"> • Latch • Handle • Hinges • Self-closing device (closer)
ULSASD+OP	<ul style="list-style-type: none"> • Hinges • Self-closing device (closer)
LSADD	<ul style="list-style-type: none"> • Latch • Handle • Hinges • Self-closing device (closer) • Flush bolt or face fixed bolt • Door Selector if rebated meeting edge or meeting edge astragal present
ULSADD	<ul style="list-style-type: none"> • Hinges • Self-closing device (closer) • Flush bolt • Door Selector if rebated meeting edge or meeting edge astragal present
DADD	<ul style="list-style-type: none"> • Top pivot & bottom strap • Self-closing device (closer)
LSADD+OP	<ul style="list-style-type: none"> • Latch • Handle • Hinges • Self-closing device (closer) • Flush bolt or face fixed bolt • Door Selector if rebated meeting edge or meeting edge astragal present
ULSADD+OP	<ul style="list-style-type: none"> • Hinges • Self-closing device (closer) • Door Selector if rebated meeting edge or meeting edge astragal present

Note:

1. The above table includes a self-closing device, but for some permanently locked fire doors a closer is not required, providing it is fitted with the appropriate signage. If this is the case the doorset must be considered a latched doorset arrangement for the purpose of leaf size envelopes defined within section 4.5.

2. It is permitted to omit the door closer and fit bolts to the inactive leaf of unlatched double doorsets. The active leaf must be fitted with a door closer and both leaves must carry the appropriate signage.

10.4 Latches & Locks

The following sections detail the permitted locks and latches which have been tested or assessed within the Halspan Prima 60 doorset design.

Doorsets fitted with only a lock without a latching function are permitted. The fitting of a lock only is not considered to change the latching arrangement of the doorset and therefore the permitted leaf size shall be established using unlatched doorset configurations as detailed within section 4.5.

Up to 2No. single point engagement locks or latches may be applied within the vertical edge of the door leaf in any individual doorset providing 200mm of uninterrupted perimeter intumescent is maintained between the two hardware items. When fitted the lock or latch bodies shall be installed at a height as detailed within the relevant section below. Refer to specific notes contained within each section for further considerations on lock or latch type.

Locks fitted within rebated meeting edges shall not be applied when it is required to remove timber from the upstand of the rebate to facilitate their application.

10.4.1 Single Point Engagement

The table below details a selection of the tested latches and locks that are approved.

Element	Manufacturer & Product Reference
Locks & latches	<ul style="list-style-type: none"> Zoo Hardware ZDL0060RSS (WF504390)
	<ul style="list-style-type: none"> Dorma – Dorma 181 mortise lock (WF189639 A)
	<ul style="list-style-type: none"> Dorma – SVP5252 mortise lock with 80mm long standard cylinder (WF189639 B)
	<ul style="list-style-type: none"> Dorma – SVP2277 next generation mortise lock (WF350451 A/B)
	<ul style="list-style-type: none"> Hoppe – AR913-S-80 SSS (WF193473/A A)
	<ul style="list-style-type: none"> Arrone (Hoppe) AR910 (WF380315B B)
	<ul style="list-style-type: none"> Hoppe (UK) Ltd AR 912-S-60-SSS (WF331430 B)
	<ul style="list-style-type: none"> Halspan – LCK-BSS-100 (WF384748B B)
	<ul style="list-style-type: none"> Halspan – LCK-BSS-200 (WF386186 B)
	<ul style="list-style-type: none"> Halspan – BOM-LCK-104 (WF380349 AR1 B)
	<ul style="list-style-type: none"> Durable collection Ltd. S-5572 (WB112-1B&2B B)
	<ul style="list-style-type: none"> DORMAKABA Mortise 170Plus/WZ 55 (TB 197-1B&2B A)
	<ul style="list-style-type: none"> Halspan – LCK-BSS-101 (CFR1809241 A/B)
	<ul style="list-style-type: none"> Hafele 911/02/145 mortise sash lock (FRR-2110/1497 A/B)
	<ul style="list-style-type: none"> Securefast plc SEU777/2R (WF415117 B)
	<ul style="list-style-type: none"> E*S Easi-T latch (RF07141 B)
	<ul style="list-style-type: none"> Dormakaba SVP 6000 80mm backset (WF523824/R A/B)
	<ul style="list-style-type: none"> Abloy OY– EL520/100 & Abloy OY EA 329 (WF364240)
	<ul style="list-style-type: none"> Abloy – EL560 Solenoid Lock 100mm backset & Abloy EL 322 keep (WF508198)
	<ul style="list-style-type: none"> Abloy – EL 560 Solenoid Lock 60mm Backset & Abloy – EA 322 keep (WF508668)
<ul style="list-style-type: none"> Abloy EL560 - 65mm backset & Abloy EA322 (WF520063) 	
<ul style="list-style-type: none"> Abloy EL560 - 100mm backset & EA 322 keep (CFR2211141) 	

Alternatively, Certifire approved components certified for use within 60-minute fire resistance applications on 54mm thick timber door and timber frames with the following specification are also deemed acceptable for both single and double leaf doorsets.

Element	Specification
Maximum forend and strike plate dimensions (excluding tongue)	235mm high x 26mm wide x 4mm thick
Maximum body dimensions	168.5mm high x 133mm wide x 18mm thick
Intumescent protection	see section 10.2
Materials	All parts essential to the locking/latching action (including the latch bolt, forend and strike) to be steel, stainless steel or brass with a melting point $\geq 800^{\circ}\text{C}$

Notes:

1. In all instances the location of the handle must be between 800 – 1500mm from the finished floor level.
2. Locks with the above specification may be fitted centrally within the thickness of the leaf or off set by a maximum of 13mm from the centreline of the door thickness to the centreline of the forend. This is based on successful testing undertaken in FRR-2010/2942 which included an offset lock and a rebated meeting edge.
3. Both mechanical and electronically powered locks which meet the specification given above are permitted.

10.4.2 Latches & Locks – Multi Point Engagement

The table below details the tested and assessed multi point latches that are approved.

Test Evidence (Tested configuration)	Item	Hardware Intumescent Protection	Minimum Perimeter Intumescent (Specified in Section 4.5)
WF198681 (LSASD)	Dorma M-SVP 5000	1mm Interdens to all concealed faces of lock bodies, under forend and under strike.	<p>2No. 15mm wide x 4mm thick seals fitted centrally within the frame reveal 10mm apart.</p> <p>Intumescent seal specification shall meet the criteria given in the text below this table and correspond to the intumescent permitted in section 4.5.</p>
WF512409 (LSASD) CFR2105131 (LSASD)	Winkhaus AV2 M105301	Winkhaus AV2 intumescent pack Ref 5084041	
CFR2105131 (LSASD)	Winkhaus AV3 M113345		
CFR2006181 (LSASD) & CFR2209201 (LSASD)	Halspan Autolock Crimebeater 3 point lock	2mm thick Halspan SLS-PAD-122 all faces of the lock body, actuator box and hook boxes and to rear of strike, actuating plate and keeps	
WF504819 (LSADD) & WF504821 (LSADD)	Glutz 18931 Mint SB	1mm Interdens® around central lockcase, top and bottom lock cases and forend plate	
RF04074 (LSASD)	GU Ferco Multipoint lock / latch	2mm Interdens® around central lockcase, top and bottom lock cases and forend plate	

Based on the test evidence the above tested and assessed multi-point locks are permitted for use with the doorset design subject to the following parameters:

Frame option: 1

Configurations: LSASD

- When a multi-point latch is fitted, the leaf perimeter edge intumescent must be located into the frame reveal along the closing edge.
- Where fitted the approved multi-point locks shall be fitted centrally to the thickness of the door leaf.
- The top and bottom locks do not need to be engaged for fire performance, except where the multi-point lock has an auto throw function the top and bottom locks must be engaged.
- The centre, top and bottom keep plates must be the same as those tested, as supplied by the manufacturer.
- In all instances the location of the spindle must be between 800–1200mm from the threshold. The multi point latch may be fitted along the entire length of the door edge, if required and as tested in report reference WF198681.
- The frame must be fitted with a stop of minimum 15mm.
- Intumescent protection to the multi-point lock used must be as tested and identified within the table above.
- The frame intumescent must be one of the following tested intumescent seals when using one of the identified multi-point locks:
 - Halspan SLS
 - ISL Therm-A-Seal
 - Lorient LP1504
 - Pyroplex

10.4.3 Cylinders

The table below details a selection of the tested cylinders that are approved.

Element	Manufacturer & Product Reference
Cylinder	<ul style="list-style-type: none"> Winkhaus XR604/6 (WF512409)
	<ul style="list-style-type: none"> Dorma – Dorma profilcylinder PC 51 / 30-30 (WF198681)
	<ul style="list-style-type: none"> Arrone (Hoppe) AR3130-CC-NP (WF380315-B)
	<ul style="list-style-type: none"> ISEO EN 1303-2005 (WF331430)
	<ul style="list-style-type: none"> Abloy OY – CY332T (WF364240)
	<ul style="list-style-type: none"> UAP – Kinetica Double 3 Kitemarked Euro Cylinder (CFR2006181)
	<ul style="list-style-type: none"> Vier V5 – 35/10/35 (CFR1909241)
	<ul style="list-style-type: none"> Glutz – GC9991.AT (WF504819)
	<ul style="list-style-type: none"> Glutz – GC9991.B (WF507671)
	<ul style="list-style-type: none"> Abloy – CY326 (WF508668)
	<ul style="list-style-type: none"> Abloy Breaksecure 3DS 59080026 (WF507664)
	<ul style="list-style-type: none"> Durable Collection Ltd – DCP M-70 (WB112-1B&2B)
	<ul style="list-style-type: none"> Dorma – Double profile cylinder DEC 150-DN 40/40 (TB 197-1B&2B)
	<ul style="list-style-type: none"> Eurolever SC11.71 (FRR-2010/2942)
	<ul style="list-style-type: none"> Hafele 916.96.076 (FRR-2110/1497)
<ul style="list-style-type: none"> EUROART CYD280 (FRR-2008/5506) 	
<ul style="list-style-type: none"> Union Assa Abloy J-U6PED4555SN Union 6 pin Euro Profile (WF415117) 	

	<ul style="list-style-type: none"> • Assa Abloy CY331T (WF437975/LR)
	<ul style="list-style-type: none"> • Kinetica 3* cylinder & turn (WF523824/R)
	<ul style="list-style-type: none"> • Halspan Kinetica 3* cylinder & turn (CFR2209201)

Alternatively, components with the following specification are also deemed acceptable.

- Where required for use with either single or multi point latches, the cylinder must be constructed of either brass or steel with a melting point in excess of 800°C.
- The cylinder must be compatible with the lock/latch.
- Cylinder dimensions may be up to 33mm high x 17mm wide at the maximum dimension and may be of euro profile or oval.
- Single and double cylinders, along with cylinder & turn are permitted.
- Door preparation for single cylinders shall penetrate no greater than 2/3rds of the door thickness.
- Intumescent protection and tightness of fitting:
 - As the lock body is protected with an intumescent material, maximum clearance between leaf and cylinder is 3mm to each edge.
 - 1mm thick MAP or non-pressure forming graphite intumescent around the cylinder is optionally permitted.

10.4.3.1 Cylinder guard & Lock Protection Plate

The testing detailed within section 3 included the following cylinder guard and lock protection plate which are therefore optionally permitted with cylinders and locks within the Prima 60 doorset design:

Test Evidence (Tested configuration)	Item	Intumescent Protection
CFR2105131 (LSASD)	Winkhaus Armorshield, two-part cylinder anti-tamper shield 64 x 22 x 22	Winkhaus AV2/AV3 intumescent pack, 5084041, fitted to the perimeter of the cylinder shield
WF512409 (LSASD)	Winkhaus ArmorPlate GBOX 02 Gearbox plate Reference 5077418	Winkhaus AV2/AV3 intumescent pack, 5084041, fitted to the lock body as tested

The above cylinder guard and lock protection plate may only be utilised with the Winkhaus AV2 or AV3 multipoint lock as detailed within section 10.4.2. The above detailed intumescent protection shall be fitted as tested.

10.4.4 Electronic locking

Based on the testing undertaken on the Prima 60 doorset design as detailed within section 3.

10.4.4.1 Surface Head Mounted Maglocks

The following maglocks have been successfully tested within the Halspan Prima 60 doorset design when the mag lock body was fitted to the door frame head with the armature or associated bracket fitted to the face of the leaf:

Test Evidence	Item
WF404075	Halspan / RGL ML1200 Standard magnetic lock with a ZL bracket and using BLK 1200 contact armature/bracket and AH 1200 armature housing.
WF523824/R	Dormakaba EM 5300 GL AH with and without Dormakaba 19860290 Z & L BRACKET FOR EM 5300

In addition to the tested and permitted maglocks detailed above the following alternative Halspan / RGL maglock bodies are permitted for use:

- ML600: Slimline mini magnet
- ML600-M: Monitored version of the ML600
- ML600-D: Double Slimline mini magnet
- ML600-D-M: Monitored version of the ML 600-D
- ML600-D-MDS: As ML600-D but with monitored door status
- ML1200-M: Monitored version of the ML1200
- ML1200-MDS: As ML1200 but with monitored door status
- ML1200-D-M: Double standard magnetic lock, monitored
- ML1200-D-MDS: As ML1200-D-M but with monitored door status

The following mounting brackets and accessories are assessed as permitted in conjunction with the ML series of maglocks:

- AH600 and AH1200: Armature housing
- BK600ZL and BK1200ZL: Z&L bracket
- BK600L and BK1200L: L bracket
- BK600-D-ZL and BK1200-D-ZL: Double Z&L bracket
- BK600-D-L and BK1200-D-L: Double L bracket
- AB600ZL-DC: Architectural Z&L bracket
- AB600CL and AB1200CL: Architectural L Bracket
- BK600-F-L/AB and BK1200-F-L/AB: Architectural F/ZL bracket
- BK600-D-FL/AB and BK1200-D-FL/AB: Double Architectural F/ZL bracket
- ADJ-600L and ADJ-1200L: Adjustable L Bracket
- MAG-STRAP and ARM-STRAP: Safety Wire Holding strap

The above ML series of maglocks, armatures or brackets have been included within this assessment as none of the items are recessed into the edge or face of the door or frame and therefore it would not be expected that their fitting would increase the risk of burn through if subjected to fire resistance testing. The dimensions of some of the alternative maglock bodies are increased from the tested product. However, as they are of identical materials to the tested product, no reduction in performance would be expected as a consequence of substitution of the tested product.

Based on the test evidence, the above listed tested and assessed alternative face fixed magnetic locks are suitable for use within the following parameters:

Frame option: 1, 2, 3, 4, 5 & 7

Configurations: LSASD, ULSASD, LSADD and ULSADD

- The maglock body must be fitted directly to the frame head or utilising one of the permitted mounting brackets.
- When using the ML series of maglocks the armature(s) can be fixed to the face of the door via separate armature housing AH600 or AH1200 so that no fixings penetrate the full door thickness. The armature housing must be fixed to the door leaf using 4mm x 22mm woodscrews and the armature plate fixed to the housing by a single 8mm coachbolt which is fixed to the armature housing. Alternatively, based on the testing detailed within WF523824/R it is considered possible to throughbolt the armature to the face of the leaf, providing there is no more than 1mm clearance between the hole and bolt.
- When using the Dormakaba EM 5300 GL AH maglock the armature must be through bolted as tested in WF523824/R.
- No recessing of frame or leaf is permitted except the inclusion of a single hole to facilitate cabling which is no greater than Ø10mm.
- When fitted the maglock shall not interrupt any fire stopping detail applied to the doorset, nor require the removal of material (except screws) from the frame section.

The fitting of face fixed magnetic locks is not considered to change the latching arrangement of the doorset and therefore the permitted leaf size shall be established using the appropriate doorset configuration based on the other latch/lock hardware fitted to the doorset.

10.4.4.2 Morticed Head Mounted Locks

The following head mounted locks have been successfully tested within the Halspan Prima 60 doorset design:

Test Evidence (Tested configuration)	Item	Intumescent Protection
CFR2007291 (DADD)	ICS Security SL 500	2mm (t) Interdens®, intumescent pads with self-adhesive applied to all concealed faces of the lock components
WF509421 (DADD)	Abloy 351M80	Abloy Intumescent kit – 1mm around the lock body, 2mm under forend and strike plate
WF509420 (DADD)	Abloy 351U80	Abloy Intumescent kit – 1mm around the lock body, 2mm under forend and strike plate
WF434693/LR Issue 2 (LSASD)	Abloy 352M80	Abloy Intumescent kit – 1mm around the lock body, 2mm under forend and strike plate
RF09010 (LSASD)	Adams Rite, Armlock® 1354	1mm thick Halspan, Graphite applied to all concealed faces of the lock components

Based on the test evidence the above morticed head mounted locks are permitted within the following parameters:

Frame option: 1 & 3

Configurations: LSASD, ULSASD, DASD, LSADD, ULSADD and DADD

Further considerations as follows shall be met:

- When fitted the edge of neither the lock body nor keep shall be closer than 73mm to the closing edge of any leaf.
- The frame intumescent shall consist of a specification which has a minimum of 2No. 15mm x 4mm intumescent seals applied to the frame head and 1No. 15mm x 4mm intumescent seal applied to the leaf head.
- The frame thickness when fitting the Abloy series of locks detailed above shall be no less than 44mm excluding stop dimensions.
- Intumescent protection applied to the lock selected shall be as tested and identified within the table above.

The fitting of morticed head mounted locks is not considered to change the latching arrangement of the doorset and therefore the permitted leaf size shall be established using the appropriate doorset configuration based on the other latch/lock hardware fitted to the doorset.

10.4.4.3 Morticed Jamb Mounted Locks

The following jamb mounted lock has been successfully tested within the Halspan Prima 60 doorset design:

Test Evidence (Tested configuration)	Item	Intumescent Protection
WF434693/LR Issue 2 (LSASD)	Assa Abloy 351U80-SET44E9146	Abloy Intumescent kit – 1mm around the lock body, 2mm under forend and strike plate

In addition to the tested and permitted morticed jamb mounted lock detailed above the following alternatives are permitted for use:

- Abloy 351M80
- Abloy 352M80

When fitted the above assessed locks shall include the same intumescent protection as tested with the Abloy 351U80 in WF434693/LR Issue 2. (Abloy Intumescent kit – 1mm around the lock body, 2mm under forend and strike plate).

The assessment of the alternative locks is on the basis that the 351U80 has been tested and that 351M80 and 352M80 are of identical dimensions to the tested 351U80, with only a variation to functionality. The maximum keep dimension permitted is 150mm high x 44mm wide x 4mm thick without strike tongue as tested in WF434693/LR Issue 2.

Based on the test evidence the above morticed jamb mounted locks are permitted within the following parameters:

Frame option: 1 & 3

Configurations: LSASD and ULSASD

Further considerations as follows shall be met:

- In all instances the location of the centre line of the lockset must be between 700 – 1300mm from the finished floor level with the lock body fitted within the frame.
- The frame intumescent shall consist of a specification which has a minimum of 2No. 15mm x 4mm intumescent seals applied centrally within the frame jambs.
- The frame thickness when fitting the Abloy series of locks detailed above shall be no less than 44mm excluding stop dimensions.
- Intumescent protection applied to the lock selected shall be as tested and identified within the table above.

The fitting of morticed jamb mounted locks is not considered to change the latching arrangement of the doorset and therefore the permitted leaf size shall be established using the appropriate doorset configuration based on the other latch/lock hardware fitted to the doorset.

10.4.4.4 Electronic Strikes

The following electronic strikes have been successfully tested in conjunction with a single point lockset.

Test Evidence	Item	Intumescent Protection
WF189639	Dormakaba Fire 447 electronic strike	2mm (t) Interdens®, intumescent pads with self-adhesive applied to all concealed faces of the strike components
WF415117	Gianni Industries Inc – GK361M-ST-1224 (Fail Secure)	1mm (t) Interdens®, intumescent pads with self-adhesive applied to all concealed faces of the strike components
WF415117	Gianni Industries Inc – GK450M-ST-1224 (Fail Safe)	1mm (t) Interdens®, intumescent pads with self-adhesive applied to all concealed faces of the strike components

Based on the test evidence only the above electronic strikes are permitted within the following parameters:

Frame option: 1

Configurations: The fitting of electronic strikes is not considered to change the latching arrangement of the doorset and therefore the permitted leaf size shall be established using ULSASD configurations as detailed within section 4.5.

Further considerations as follows shall be met:

- The frame intumescent shall consist of a specification which has a minimum of 2No. 15mm x 4mm intumescent seals applied centrally within the frame jambs 10mm apart.
- The frame width shall be no less than 38mm excluding stop dimensions.
- The frame must be fitted with a planted or rebated stop of minimum 19mm high x 40mm deep.
- Intumescent protections applied to the electronic strike selected shall be as tested and identified within the table above.
- Fitted to suit a single point lock (see section 10.4.1), with the lock protected as detailed within section 10.2.

10.4.5 Access control systems

10.4.5.1 Electro-mechanical locks

The electro-mechanical access control systems detailed in the following sections have been successfully tested and assessed with the Prima 60 door blanks and are therefore suitable for use within the scope stated herein.

Test Evidence (Tested configuration)	Lock Body (Dimensions)	Handleset (Dimensions)	Intumescent Protection
WF379042 (ULSASD)	Dorma Kaba – Quantum hotel lock (Body - 148mm long x 100mm wide x 22 deep Forend – 204mm long x 26mm wide)	Dorma Kaba – Quantum hotel lock (Lever handle with back plate of 255mm x 89mm wide x 21mm projection to one face with Lever handle on rose of Ø75mm x 15mm thick and Card reader of 74mm diameter x 12.5 deep fitted including 75mm diameter x 2mm thick rubber gasket to the opposing face)	1mm Interdens to all concealed faces of lock body, under forend and under strike.
WF367907 (LSASD)	ANSI DB mortice lock (Body - 152mm long x 100mm wide Forend – 203mm long x 28mm wide) & Morticed LCA 6343 positioned such that the centre of the RFID card reader is 125mm above the spindle for the handle (Body rebate - 108mm long x 104mm wide)	VingCard Essence RFID assembly	1mm Interdens to all concealed faces of all morticed items, under forend and under strike.
		VingCard Classic RFID assembly	
		VingCard Signature RFID assembly	

<p>20220808-005920 (LSASD)</p>	<p>NSP Europe Ltd – Epic Lockset (Body - 154mm long x 106mm wide x 23 deep Forend – 204mm long x 28.5mm wide)</p>	<p>NSP Europe Ltd – Epic Lockset std lever on rose, RFID reader & thumb turn cylinder</p>	<p>2mm monoammonium phosphate intumescent around lockcase, battery pack & circuit board, forend plate and keep. Keep dust pocket lined with 1mm monoammonium phosphate intumescent</p>
<p>WF520064 (LSASD)</p>	<p>Abloy Aperio L100 BL560 – 65mm RFID locking system. (Body - 166mm long x 98mm wide x 15.4 deep Forend – 225mm long x 24mm wide)</p>	<p>Abloy Aperio L100 long plate handleset with escutcheon, including RFID card readers. (282mm high x 48mm wide to one face of the leaf and 348mm x 52mm to the opposing face) Assa Abloy E100 Standard escutcheon Euro profile, including RFID readers² (312mm high x 41mm wide to both faces) Assa Abloy Aperio H100 lever type handle¹ (55mm wide x 56mm high footprint)</p>	<p>1mm MAP to all concealed faces of lock body, under forend and under strike.</p>
<p>WF437975/LR (LSASD)</p>	<p>Abloy OY Mortice lock/latch AL560_200170 (Body – 168.5mm long x 98mm wide x 16.5mm deep Forend – 235mm long x 24mm wide) Strike plate Assa Abloy EA329</p>	<p>Assa Abloy Reader HF Abloy Oy 953032 handleset</p>	<p>1mm MAP to all concealed faces of lock body, under forend and under strike.</p>

WF327018 (LSASD)	Codelocks Ltd – CL 5010, tubular mortice latch	Codelocks Ltd – CL 5010	Codelocks Ltd – Code Locks Fire Kit consisting of: 3No. 8mm diameter graphite based intumescent tubes positioned in fixing bore holes Data cable bore hole lined with 1mm thick Interdens® Spindle bore hole lined with 2No. layers of 1mm thick Interdens® 1mm thick Interdens® applied under the forend and keep.
	Codelocks Ltd – CL 2255, tubular mortice latch	Codelocks Ltd – CL 2255	
WF397957 (LSASD)	Codelocks Ltd – CL 4510, tubular mortice latch	Codelocks Ltd – CL 4510	1mm thick Interdens® applied under the forend and keep.
	Codelocks Ltd – CL 5510, tubular mortice latch	Codelocks Ltd – CL 5510	

Based on the test evidence the above tested and assessed electro-mechanical locksets are permitted for use with the doorset design subject to the following parameters:

Configurations:

All of the above listed locks: LSASD, ULSASD

In addition, the above listed code locks using a tubular mortice latch: LSADD & ULSADD

- The frame intumescent shall consist of a specification which has a minimum of 2No. 15mm x 4mm intumescent seals applied centrally within the frame jambs 10mm apart, or at the meeting edge where applicable.
- The frame must be fitted with a stop of minimum 15mm.
- Positioning requirements shall be within the parameters as detailed below based on the type of lock which is utilised:
 - Locks with forends equal to or less than 65mm height may be fitted between 800mm – 1530mm from the floor level to the spindle.
 - Locks with forends greater than 65mm height may be fitted between 800mm – 1200mm from the floor level to the spindle.

Note:

- 1) The H100 lever type handles have been included for use, as due to their metallic construction it is not likely to detract from the fire resistance performance of the doorset design, when fitted with the tested lock and as an alternative to the L100.
- 2) The E100 Escutcheon Euro profile handles including RFID readers have been included for use, as they are of smaller dimensions as the tested L100 and comprise similar electronic components within a metallic construction and so are not likely to detract from the fire resistance performance of the doorset design, when fitted with the tested lock and as an alternative to the L100.

10.4.5.2 Contact Sensors

The contact sensor detailed in the following section has been successfully tested and assessed with the Prima 60 doorset design and are therefore suitable for use within the scope stated herein.

Manufacturer & Product Reference (Test evidence)	Dimensions	Intumescent Protection
<ul style="list-style-type: none">Abloy 1076D (WF508668 WF508198) &	Sensor to Leaf: Ø26mm x 40mm Sensor to Frame: Ø26mm x 29mm	1mm (t) Halspan Graphite applied to all mortices

The above detailed contact sensors may be fitted subject to the following requirements:

- The sensor must be fitted centrally to the thickness of the leaf.
- The sensor must be fitted to the head of the doorset 100mm in from the closing edge of the leaf.
- The above detailed intumescent protection must be fitted.
- The intumescent specification for the doorset design must include at least 2No. 15mm wide x 4mm thick seals within the frame reveal.

10.5 Handles & Escutcheons

The table below details a selection of the tested handles and escutcheons that are approved.

Element	Manufacturer & Product Reference
Handles	• Dormakaba c-Lever pro (26xy-K6) (WF523824/R A/B)
	• Dorma - PLUS 8100FS/6500/6612 levers (WF189639 A)
	• Hoppe – FS-K138/202K Paris (WF189639 B)
	• Hoppe – Palladio Quickfit handle Lever (WF512409)
	• Dorma – PLUS 8906/6500/6612 levers, (WF350451 A/B)
	• Winkhaus Palladio quick fit lever (CFR2105131 B)
	• Arrone (Hoppe) Paris E138/42H/42HS (WF380315B B)
	• HOPPE - AR3901/10-UN-SSS (WF193473/A)
	• Hoppe AR3901/29-SSS (WF193473/A)
	• UAP – DH243-DUO-SSS-NANOCOAST (CFR2006181 A/B)
	• Halspan – LCK-MSK-200 (CFR1909241 A/B)
	• Halspan – LCK-MSK-274 (CFR2209201)
	• Glutz – GF.NES.4.GFB lever on GF.NES.5.GB (WF504821 AB)
	• HEWI – 162XAH12.530 (WF508198 A/B)
	• Hewi – 162XAH12.530 (WF508668 A)
	• Abloy 319242/PZ+BL (WF507664 A/B)
• Durable Collection Ltd HL42 SSS (WB 112-1B&2B B)	
• Eurolever SS140X (FRR-2010/2942 A/B)	

	<ul style="list-style-type: none"> • Hafele LDH 2170 (FRR-2110/1497 A/B)
	<ul style="list-style-type: none"> • Altro -SAA Lynx Pattern Latch set (CFR1509291 A)
	<ul style="list-style-type: none"> • EUROART LRS201/SSS (FRR-2008/5506 A)
	<ul style="list-style-type: none"> • Locke & Co. Ltd 2000 series Lever on backplate (WF391351 B)
	<ul style="list-style-type: none"> • Assa Abloy 319242/PZ+BL (CFR2211141 B)
	<ul style="list-style-type: none"> • Stanza Architectural Hardware – ZCA030SA (CFR1707241)
Escutcheons	<ul style="list-style-type: none"> • Dorma – PZ (WF350451 A/B)
	<ul style="list-style-type: none"> • Dorma – Dorma Plus Cylinder rose (WF198681 B)
	<ul style="list-style-type: none"> • Zoo Architectural Hardware – ZCS001SS – (CFR1909241 A)
	<ul style="list-style-type: none"> • Glutz – GF.NES.8.GFB Square escutcheon (WF504819 AB)
	<ul style="list-style-type: none"> • Smith and Locke SKU-6917SKU / Euro Escutcheon (WF415117 B)
	<ul style="list-style-type: none"> • HEWI – 306.23X (WF508198 A)
	<ul style="list-style-type: none"> • Hewi – 306.23 (WF508668 A/B)
	<ul style="list-style-type: none"> • Eurolever square escutcheon SS5011 (FRR-2010/2942 A/B)

Alternative handles are permitted providing they meet the specification given below:

- Steel, stainless steel, brass, aluminium or bronze are permitted.
- Surface fixings or through fixings are permitted. If through fixed there must be no more than 2mm clearance between the hole and the fixing.
- The hole through the leaf to facilitate the spindle must be no greater than 25mm diameter.

The design may be either handle on rose or handle on back plate up to the following maximum sizes:

- Handle on rose with a rose diameter up to 56mm.
- Handle on back plate with a back plate size up to 260mm high x 200mm wide.
- Handle length 250mm.

The handle must be compatible with the lock/latch, such that the closing action of the doorset is not impeded.

Alternative escutcheons are permitted providing they meet the specification given below:

- Steel, stainless steel, brass, aluminium or bronze are permitted.
- Surface fixings or through fixings are permitted. If through fixed there must be no more than 2mm clearance between the hole and the fixing.
- The escutcheon may be up to Ø56mm overall and up to 10mm thick.

10.6 Hinges and Pivots

10.6.1 Butt Hinges

The table below details a selection of the tested butt hinges that are approved.

Element	Manufacturer & Product Reference
Butt Hinge	<ul style="list-style-type: none"> Halspan Limited – HIN-BSS-108 (WF520064) BOM-HIN-202 when paired with SLS-PAD-103 intumescent
	<ul style="list-style-type: none"> Halspan Limited – HIN-BSS-104 (CFR2109021) BOM-HIN-201 when paired with SLS-PAD-103 intumescent
	<ul style="list-style-type: none"> Halspan Limited – HIN-BSS-103 (CFR2103161) BOM-HIN-200 when paired with SLS-PAD-103 intumescent
	<ul style="list-style-type: none"> Royde and Tucker Ltd – Hi-Load 102 (WF390174)
	<ul style="list-style-type: none"> Royde and Tucker Ltd – Hi load 125 (WF379042)
	<ul style="list-style-type: none"> Royde and Tucker Ltd – Hi-Load G4530-FS-BSS (CFR1811211)
	<ul style="list-style-type: none"> Royde and Tucker Ltd – H101 (PF14102)
	<ul style="list-style-type: none"> Royde and Tucker Ltd – H105 Gi load lift off type hinges (RF07141)
	<ul style="list-style-type: none"> Dorma – 3090F 2BB (TB197-1B&2B)
	<ul style="list-style-type: none"> Dorma – 3094F (WF350451)
	<ul style="list-style-type: none"> Hoppe (UK) Ltd – AR 8380 SSS (WF331430)
	<ul style="list-style-type: none"> Glutz – GH2351.R.3K (WF504819)
	<ul style="list-style-type: none"> Allgood – SS8066R Grade 14 (WF508668)
	<ul style="list-style-type: none"> Zoo Hardware Ltd – ZHS243R (CFR2002051)
<ul style="list-style-type: none"> EUROART – HINBB433/304/SSS (FRR-2008/5506) 	
<ul style="list-style-type: none"> Cooke Brothers Ltd – Phoenix concealed bearing butt hinge 7730 (CFR1708031) 	

Alternatively, Certifire approved components certified for use within 60-minute fire resistance applications on 54mm thick timber door and timber frames with the following specification are also deemed acceptable for both single and double leaf doorsets.

Element	Specification
Blade height:	90 - 120mm
Blade width (excluding knuckle):	29 - 35mm (Fitted within the leaf frame) (See note 1)
Blade thickness	2.5 - 4mm
Fixings:	Minimum of 4 No. 30mm long No. 8 or No.10 steel wood screws per blade
Materials:	Steel or stainless steel or brass with a melting point of greater than 800 degrees Celsius.

Intumescent protection shall be as defined in section 10.2 in all instances.

Note:

1. Projection hinges with blade widths greater than the widths detailed above are permitted providing that no more than 35mm of each blade is rebated within the leaf edge or frame.

In all instances, the hinges must have the following specification.

Leaves less than 2400mm (h) must be hung on a minimum of 3 hinges. Leaves greater or equal 2400mm (h) must be hung on a minimum of 4 hinges.

Leaves less than 1200mm (h) can be hung on a minimum of 2 hinges located 150mm from the top and bottom of the door leaf (top hinge location is measured from the top of the hinge blade to the top of the door leaf and bottom hinge location is measured from the bottom of the hinge to the bottom of the door leaf).

Element		Specification	
Hinge positions:	If 3 hinges are required:	Top	100 –180mm from the head to top of hinge
		2 nd	Minimum 200mm from top hinge or centrally fitted between top and bottom hinge
		Bottom	150 - 250mm from the foot of leaf to bottom of hinge
	If 4 hinges are required:	Top	100-180mm from the head to top of hinge
		2 nd & 3 rd	Equispaced between top and bottom or 2 nd hinge 200mm from top hinge and 3 rd hinge equally spaced between 2 nd and bottom hinge
		Bottom	150 - 250mm from the foot of leaf to bottom of hinge
Intumescent protection:		See section 10.2	

Additional hinges may be added providing the requirement of 200mm between adjacent items of hardware is maintained.

10.6.2 Concealed Hinges

Concealed hinges are permitted with Frame 2 and Frame 1 as detailed in the following sections.

10.6.3 Concealed Hinges – Frame 1

The concealed hinges detailed in the following section have been successfully tested with Prima 60 in conjunction with a hardwood frame:

Test Evidence (Tested configuration)	Hinge (Dimensions)	Intumescent Protection	Minimum Perimeter Intumescent (Specified in Section 4.5)	Minimum Number of Hinges
WF323822 (ULSASD)	Bartels Systembeschlage GmbH Pivota® DX 300 3-D (Hinge 270mm (h) x 30mm (w) x 35 (d) to frame & 270mm (h) x 28mm (w) x 35 (d) to leaf)	2mm (t) Lorient Polyproducts Limited, Interdens® applied to all concealed faces of each hinge blade.	2No. 15mm wide x 4mm thick seals fitted centrally within the frame reveal 10mm apart. Intumescent seal specification shall meet the criteria given in the text below this table and correspond to the intumescent permitted in section 4.5.	2
	Bartels Systembeschlage GmbH Pivota® DX 101 3-D (Hinge 180mm (h) x 30mm (w) x 30 (d) to both frame & leaf)			2
WF348445/R Issue 2 (ULSASD)	Simonswerk GmbH Concealed hinge system TECTUS TE 527 3D (Hinge 155mm (h) x 26mm (w) x 30 (d) to frame & 155mm (h) x 26mm (w) x 32 (d) to leaf)	1mm (t) Lorient Polyproducts Limited, ITH- TECTUS- TE525-10 (kit), MAP		2
WB112-1B & 2B (LSASD)	Simonswerk Tectus TE 340 3D (Hinge 160mm (h) x 28mm (w) x 31 (d) to frame & 33.5 (d) to leaf)	1mm (t) Lorient Polyproducts Limited, Interdens® applied to all concealed faces of each hinge blade.		3

<p>CFR1711241 (ULSASD)</p>	<p>Royde and Tucker HC605 (Hinge 119mm (h) x 22mm (w) x 6 (d) to frame & 184mm (h) x 33mm (w) x 32 (d) to leaf)</p>	<p>1mm & 2mm (t) Interdens®, Type 15 (1mm) applied around face of the body within leaf. Type 36 (2mm) applied to all flat surfaces parallel to the reveal. See photo in section 10.6.3.1.</p>		<p>2</p>
<p>CFR1909241 (LSADD)</p>	<p>Halspan CEAM Art Stars 1131 Concealed Hinges (Hinge 160mm (h) x 32mm (w) x 29 (d) to both frame & leaf)</p>	<p>1mm (t) Halspan ES1131, graphite applied to all concealed faces of each hinge blade.</p>		<p>4</p>
<p>RF04074 (LSASD)</p>	<p>Cairney Hardware SOSS (hinge footprint 117mm long x 25mm wide to both frame and leaf)</p>	<p>2mm (t) Interdens®, applied to all concealed faces of each hinge blade.</p>	<p>Intumescent specification to be as detailed within section 4.5 specification – A/11, B/11, F/11 & G/11</p>	<p>3</p>

In addition to the tested and permitted concealed hinges detailed above the following alternative concealed hinges are permitted for use:

Alternative Bartels Systembeschlage GmbH Pivota® concealed hinges:

- DX 100 3-D (Hinge 180mm (h) x 27mm (w) x 30 (d) to frame & 180mm (h) x 24mm (w) x 30 (d) to leaf)
- DX 101 3-D with RC2 option (Hinge 180mm (h) x 30mm (w) x 30 (d) to frame & 180mm (h) x 30mm (w) x 30 (d) to leaf)
- DX 102 3-D (Hinge 180mm (h) x 30mm (w) x 30 (d) to frame & 180mm (h) x 24mm (w) x 30 (d) to leaf)
- DX 200 3-D (Hinge 235mm (h) x 30mm (w) x 35 (d) to frame & 235mm (h) x 28mm (w) x 35 (d) to leaf)
- DX 200 3-D with RC2 option (Hinge 235mm (h) x 30mm (w) x 35 (d) to frame & 235mm (h) x 28mm (w) x 35 (d) to leaf)

- DX 300 3-D with RC2 option (Hinge 270mm (h) x 30mm (w) x 35 (d) to frame & 270mm (h) x 28mm (w) x 35 (d) to leaf)

When fitted the above assessed concealed hinges shall include the same intumescent protection as tested with the Bartels Systembeschlage GmbH Pivota® DX 300 3-D in WF323822. (2mm (t) Lorient Polyproducts Limited, Interdens® applied to all concealed faces of each hinge blade).

The position of the hinges within the leaf thickness shall be as tested, at 4mm from the opening face of the leaf.

The assessment of the alternative Bartels Systembeschlage GmbH Pivota® concealed hinges is on the basis that the DX 300 3-D and DX 101 3-D have been tested and that the assessed concealed hinges are of dimensions between the tested sized, with only a variation to functionality.

Alternative Simonswerk Tectus concealed hinges:

- Tectus 526 3D (Hinge 155mm (h) x 26mm (w) x 33 (d) to frame & 155mm (h) x 26mm (w) x 36 (d) to leaf)

When fitted the above assessed concealed hinges shall include the same intumescent protection as tested with the TECTUS TE 527 3D in WF348445/R Issue 2 (1mm (t) Lorient Polyproducts Limited, MAP or Interdens® applied to all concealed faces of each hinge blade).

The assessment of the alternative concealed hinges is on the basis that the TECTUS TE 527 3D has been tested in test WF348445/R Issue 2 and that the assessed concealed hinge is of the same dimensions as tested and the materials are now of die cast stainless steel rather than zinc-plated mild steel. This variation is not expected to reduce the fire resistance performance and therefore is permitted.

Based on the test evidence the above tested and assessed concealed hinges are permitted for use with the doorset design subject to the following parameters:

Frame option: 1

Configurations: LSASD, ULSASD, LSADD, ULSADD

- Leaves less than 2206mm (h) must be hung on the minimum number of hinges as given in the table above.
- Leaves of 2206mm (h) or greater must be hung on either 3 hinges or the minimum number of hinges as given in the table above, whichever number is greater for the selected hinge.
- Regard should be paid to the maximum door mass permitted and it is permitted to increase the number of hinges above the assessed minimum quantity where required up to a maximum of 4.
- Intumescent protection to the concealed hinges used must be as tested and identified within the table above.
- Intumescent protection to the concealed hinges used must be as tested and identified within the table above. When the selected concealed hinge is Cairney Hardware SOSS, the leaf perimeter edge intumescent may be either of the options specified.
- When a concealed hinge is fitted with Frame 1 and being used with 2No 15mm x 4mm perimeter intumescent seals, the frame intumescent must be one of the following tested intumescent seals when using one of the identified concealed hinges:
 - Halspan SLS
 - ISL Therm-A-Seal
 - Lorient LP1504
 - Pyroplex

Hinge positions shall meet the following specification:

Element		Specification	
Hinge positions:	If 2 hinges are required:	Top:	100 –150mm from the head to top of the hinge
		Bottom:	120 – 323mm from the foot of leaf to the bottom of the hinge
	If 3 hinges are required:	Top	100 –150mm from the head to top of the hinge
		2 nd	Centrally fitted between top and bottom hinges
		Bottom	100 - 150mm from the foot of leaf to bottom of the hinge
	If 4 hinges are required:	Top	100 -120mm from the head to top of the hinge
		2 nd	2 nd hinge 200 - 250mm from the top hinge
		3 rd	3 rd hinge equally spaced between 2 nd and bottom hinges
		Bottom	100 - 120mm from the foot of leaf to bottom of the hinge

10.6.3.1 Royde and Tucker HC605 intumescent protection

The following photographs show the intumescent protection used with the HC605 in test CFR1711241:

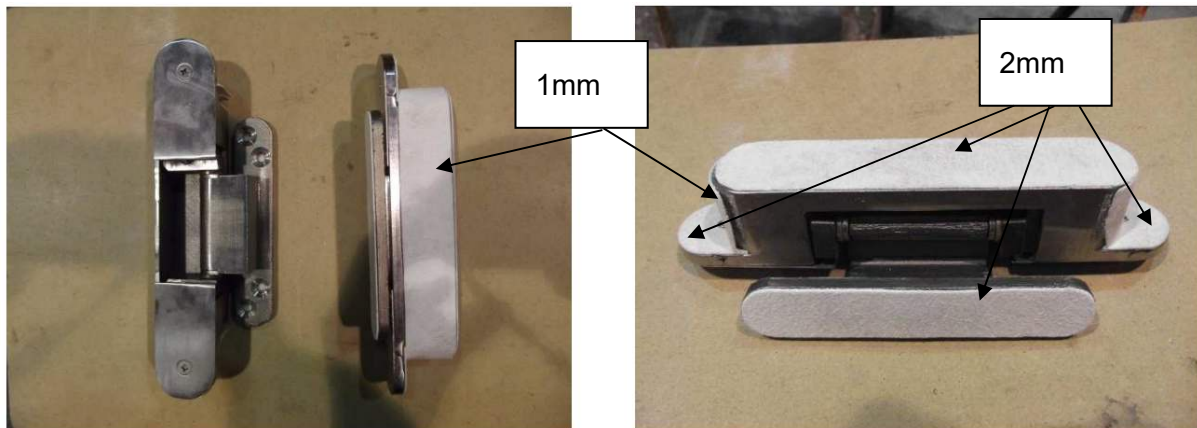

10.6.4 Concealed Hinges – Frame 2

The concealed hinges detailed in the following section have been successfully tested with Prima 60 in conjunction with a Beech frame:

Test Evidence (Tested configuration)	Hinge (Dimensions)	Intumescent Protection	Perimeter Intumescent (Specified in Section 4.5)
FRR-2110/1497 (LSASD – Beech frame)	Simonswerk TECTUS TE 340 3D (Hinge 160mm (h) x 28mm (w) x 31 (d) to frame & 33.5 (d) to leaf)	2mm (t) Hafele, MAP, 924.17.197, applied to all concealed faces of each hinge blade.	Intumescent specification to be as detailed within section 4.5 specification – A/28 & F/29
FRR-2110/1498 (LSADD – Beech frame)			

In addition to the tested and permitted concealed hinges detailed above the following alternative concealed hinges are permitted for use with Frame 2:

Alternative Simonswerk Tectus concealed hinges:

- Tectus 526 3D (Hinge 155mm (h) x 26mm (w) x 33 (d) to frame & 155mm (h) x 26mm (w) x 36 (d) to leaf)
- Tectus 527 3D (Hinge 155mm (h) x 26mm (w) x 33 (d) to frame & 155mm (h) x 26mm (w) x 36 (d) to leaf)

When fitted the above assessed concealed hinges shall include the same intumescent protection as tested with the TECTUS TE340 3D in FRR-2110/1497 (2mm (t) Hafele, MAP, applied to all concealed faces of each hinge blade).

The assessment of the alternative concealed hinges is on the basis that the TECTUS TE 340 3D has been tested in test in test FRR-2110/1497 and that the assessed concealed hinges are of reduced dimensions, with materials of die cast stainless or zinc-plated mild steel. These variations are not expected to reduce the fire resistance performance and therefore these alternatives are permitted.

Based on the test evidence the above tested and assessed concealed hinges are permitted for use with the doorset design subject to the following parameters:

Frame option: 2

Configurations: LSASD, LSADD

- When a concealed hinge is fitted with Frame 2, the leaf perimeter edge intumescent must be as detailed within section 4.5 specification – A/28 & F/29.
- A minimum of 4 hinges is required.
- The frame must be fitted with a stop of minimum 15mm.
- Intumescent protection to the concealed hinges used must be as tested and identified within the table above.

Hinge positions shall meet the following specification:

Specification	
Top	100-150mm from the head to top of hinge
2 nd	200mm from top hinge
3 rd	Equispaced between between 2 nd and bottom hinge
Bottom	100 - 150mm from the foot of leaf to bottom of hinge

10.6.5 Pivot sets

Pivots are permitted with floor springs and concealed transom closers where this is permitted within sections 10.7.4 and 10.7.5.

The following pivot set is only permitted with the Geze Boxer P 2-4 concealed overhead closer, where permitted in the table in section 10.7.3.

Test Reference	Manufacturer & Product Reference	Intumescent Protection
CFR2007291	Bottom Pivot – Geze TS137A	Bottom Strap – BASF Wolman Interdens® 1(t) lines all surfaces of the rebate
	Bottom Strap – Geze Door rail model C TS36/184	Top Pivot – 1(t) Geze Intumescent pack graphite to all faces of the top pivot hinge
	Top pivot hinge – Geze boxer adjustable pivot hinge model C	

Other than specified above, pivots are not permitted unless specifically detailed with particular items of hardware.

10.7 Doorset Self Closing

Doorset automatic self-closing can be provided by:

- Overhead face fixed closers
- Concealed jamb mounted closers
- Concealed overhead closers
- Floor springs with top pivots and bottom straps
- Concealed transom mounted closers

Automatic doorset self-closing devices such as offset pivots used with floor springs are not considered acceptable for use with the Prima 60 doorset range.

10.7.1 Overhead Face Fixed Closer

The table below details a selection of tested overhead face-fixed closers that are approved.

Element	Manufacturer & Product Reference
Overhead face-fixed closers	<ul style="list-style-type: none"> • Halspan Limited – Halspan 6000 Eco Closer (CLR-AGN-100) (CFR 2211141)
	<ul style="list-style-type: none"> • Halspan 6100 Cam action closer (WF520064 A/B P60)
	<ul style="list-style-type: none"> • Halspan – 9000 Series Power closer (WF523941/R)
	<ul style="list-style-type: none"> • Halspan – 9100 series Cam Action Door Closer (CFR2103161)
	<ul style="list-style-type: none"> • Dorma door controls TS83 (RF07141)
	<ul style="list-style-type: none"> • Dorma TS73V/RA (TB 197 - 1B&2B)
	<ul style="list-style-type: none"> • Dorma – TS-Profil (WF189639)
	<ul style="list-style-type: none"> • Dorma Kaba – TS92G EMF with G-EMF guide rail and G-EMF angle bracket (WF379042)
	<ul style="list-style-type: none"> • Dorma – Dorma TS 93 B EN 5-7 with GN slide Channel (WF198681)
	<ul style="list-style-type: none"> • Dorma Ltd – TS72 (CFR1711241)
<ul style="list-style-type: none"> • Dorma UK Limited TS68 (CFR1708031) 	

	<ul style="list-style-type: none">• Dormakaba TS71 (BMTFEP16037)
	<ul style="list-style-type: none">• Briton 121 CE (WF323822)
	<ul style="list-style-type: none">• Hoppe (UK) Ltd AR3500MSE (WF331430)
	<ul style="list-style-type: none">• Geze – TS2000V (BMT14102)
	<ul style="list-style-type: none">• Geze TS2000 (BMTFEP16037)
	<ul style="list-style-type: none">• Rutland TS3204 (BMTFEPF14012B)
	<ul style="list-style-type: none">• Assa Abloy DC250 door closer DC194 guide rail DC194 mounting plate (WF437975/LR)

Alternatively, components with the following specification are also deemed acceptable.

- Certifire approved overhead face-fixed closers for 60-minute fire resistance applications on 54mm thick timber door and timber frames.

Note:

It must be ensured that the closer is of sufficient strength and power to ensure the door leaf/leaves fully engage into the frame reveal.

10.7.2 Frame Jamb Mounted Closer

These items are suitable in the following applications only:

Frame option: 1

Configurations: LSASD, ULSASD, LSADD, ULSADD

The table below details the tested concealed jamb mounted closers that are approved.

Element	Manufacturer & Product Reference
Jamb mounted concealed closer	<ul style="list-style-type: none">Perko Powermatic R100 (WF508198)Forend: 140mm (h) x 28mm (w) Body: 178mm (d)
	<ul style="list-style-type: none">Perko Powermatic R108 (WF401347)151mm (h) x 32mm (w) x 178mm (d)

The Perko-Powermatic R100 and R108 are permitted for use with the main part of the closer body recessed within the centre of the leaf thickness and subject to meeting the following requirements:

- Recessing for closers shall result in a tight fit, allowing for any intumescent protection.
- The fixings supplied by the closer manufacturer must be used.
- The closer units shall not be fitted higher than 1100mm above the bottom edge of the leaf.
- Intumescent Protection:
 - The above detailed jamb mounted concealed closers shall be fitted with intumescent protection which comprises 2mm Interdens® to all concealed faces.
- The mortice cut out must be no closer than 10mm to any glazing aperture or feature groove (WF330214 Issue 2).

Note:

It must be ensured that the jamb mounted concealed closer is of sufficient strength and power to ensure the door leaf/leaves fully engage into the frame reveal.

10.7.3 Concealed Overhead Self Closing Device

The tables below detail the tested and assessed concealed overhead closers permitted within the Halspan Prima 60 doorset design, with the body of the concealed closer morticed into the top of the door leaf and the track morticed into the frame head.

Concealed overhead closers are not permitted within flush overpanels.

In all instances the maximum leaf dimensions for all doorsets which include concealed overhead closer must not be greater than:



- Height: 2400mm.
- Width: 1060mm

Latched & Unlatched Single Acting Configurations					
Permitted Frame Option(s)		Frame 1 Only			
Manufacturer & Product Reference (Test Reference)	Intumescent Protection	Closer Body Dimensions	Closer Slide Arm Dimensions	Perimeter Intumescent Specification (see section 4.5)	Minimum Head Stop Height (mm)
Dormakaba ITS96 EN2-4 with G96N Arm and Slide channel (WF523824/R)	1mm Interdens® around body 2mm Interdens® around slide channel	Forend 338mm (l) x 3mm (h) x 32mm (w) Body 242mm (l) x 42mm (h) x 32mm (w)	440mm (l) x 20mm (h) x 31mm (w)	Any permitted single acting seal configuration providing: They include 2No. 15mm (w) x 4mm (t) seals applied 10mm apart centrally within the frame reveal & 1No. 15mm (w) x 4mm (t) seal applied centrally within the leaf head.	20
Dormakaba ITS 96 FL EN3-6 with G96 N20 arm and slide channel (WF379041 B)		Body 476mm (l) x 51mm (t) x 39.5mm (w)			

Dormakaba ITS96 EN3-6 with G96EMF arm and slide channel (WF379042 B)		Body 256mm (l) x 51mm (t) x 39.5mm (w)	527mm (l) x 30 mm (w) x 31mm (d)	<ul style="list-style-type: none"> • Pyroplex • Lorient • ISL <p>Where the intumescent specification defined within section 4.5 only includes 2No. 15mm (w) x 4mm (t) seals applied 10mm apart centrally within the frame reveal, these specifications may be utilised providing the leaf head also includes an additional 1No. 15mm (w) x 4mm (t) seal of the same type applied centrally within the leaf head.</p>	
Dormakaba ITS 96 size EN2-4 with G96N20 armset (WF350451 A)		Body front plate 338mm (l) x 32mm (w)	440mm (l) x 12mm (h) x 20mm (w)		
Halspan Limited 6200 Eco Concealed closer CCR-CCL-024 BOM-CCL-024 (Including SLS- PAD-130 intumescent) (CFR2209201)	Halspan SLS-PAD-130 Ammonium phosphate 2mm (t) encasing closer and track bodies	Forend: 3mm (h) x 285mm (w) x 32mm (d) Body 54mm (h) x 215mm (w) x 32mm (d)	20mm (h) x 460mm (l) x 30mm (d)		15
Halspan 9200 Concealed closer CLR-CCL-102 (CFR2105131 and CFR2209201) BOM-CCL-025 (Including SLS- PAD-131 intumescent)	2mm (t) Halspan SLS- PAD-131, ammonium phosphate encases closer body and track casing and to both sides of friend and to remainder of aperture beside forend with 89mm x 33mm	Body 260mm (l) x 37 (w) x 59mm (h) Forend 330mm x 37mm x 3mm	460mm (l) x 30 (w) x 20 (h)		15

<p>Boss Door Controls Ltd Concealed overhead door closer Boss ITS6.224 EN2-4 (CFR1909241 Revision 1)</p>	<p>Boss FD60 intumescent pack for ITS6224, 1mm x 98mm x 40mm to top of forend and 1mm (t) to all concealed faces of closer body. 2mm (t) to all rear faces of closer track</p>	<p>Forend: 298mm (l) x 32mm (w) Body: 210mm (l) x 51mm (h) x 32mm (w)</p>	<p>460mm (l) x 19mm (h) x 29mm (d)</p>		<p>15</p>
<p>Rutland ITS 11204 concealed closer (BTC 16702F)</p>	<p>1mm Therm-A-Flex on top of face plate at head of leaf 2mm Therm-A-Flex all vertical sides of rail</p>	<p>Body 53mm (h) x 299mm (w) x 31mm (d)</p>	<p>Rail: 460mm (l) x 30mm (w)</p>		<p>25</p>

Latched Single Acting Configurations – Enhanced Intumescent Specification					
Permitted Frame Option(s)		Frame 1 or 2 Only			
Manufacturer & Product Reference (Test Reference)	Intumescent Protection	Closer Body Dimensions	Closer Slide Arm Dimensions	Perimeter Intumescent Specification (see section 4.5)	Minimum Head Stop Height (mm)
Geze-Boxer (FRR-2110/1497) (FRR-2110/1498)	Hafele/Lorient protection kit 2mm (t) MAP around closer body in leaf and around guide rail in frame	Forend 270mm (l) x 3mm (h) x 32mm (d) Body 42mm (h) x 240mm (l) x 32mm (w)	Rail: 440mm (l) x 12mm (h) x 20mm (w)	Any permitted latched single acting seal configuration providing: They include 2No. 15mm (w) x 6mm (t) seals applied 15mm apart centrally within the frame reveal & 1No. 15mm (w) x 4mm (t) seal applied centrally within the leaf head. Only the seal configurations manufactured by the following manufacturers are permitted: • Lorient	15

Double Acting Configurations				
Permitted Frame Option(s)		Frame 1 Only – Additionally the frame head must be increased to 120mm (d) x 45mm (h)		
Manufacturer & Product Reference (Test Reference)	Intumescent Protection	Closer Body Dimensions	Closer Slide Arm Dimensions	Perimeter Intumescent Specification (see section 4.5)
<p>Geze Boxer 2-4 (CFR2007291 Revision 2)</p> <p>When Double acting this concealed overhead closer must be fitted with the tested pivot set, see section 10.6.5.</p>	<p>Geze Boxer intumescent pack 1mm (t) graphite to all faces of closer and track</p>	<p>Forend 4mm (h) x 340mm (l) x 33mm (w) Body 42mm (h) x 240mm (l) x 32mm (w)</p>  	<p>Track: 440mm (l) x 31mm (h) x 20mm (w)</p>	<p>Any permitted double acting seal configuration providing: They include 2No. 15mm (w) x 4mm (t) seals applied centrally within the frame reveal.</p> <p>Only the seal configurations manufactured by the following manufacturers are permitted:</p> <ul style="list-style-type: none"> Lorient <p>Where the intumescent specification defined within section 4.5 only includes 2No. 15mm (w) x 4mm (t) seals applied 10mm apart centrally within the frame reveal, these specifications may be utilised providing the leaf head also includes an additional 1No. 15mm (w) x 4mm (t) seal of the same type applied centrally within the leaf head and the distance between the two seals within the frame reveal is increased to 20mm in the frame head.</p>

Some of the above assessed concealed closers have been successfully tested using a 54mm timber based doorset design. The assessment is on the basis that other concealed closers of similar sizes have been successfully tested with the Prima 60 doorset design with comparable intumescent specifications.

Based on the test evidence, the above tested and assessed concealed closers are permitted for use with the doorset design subject to the following parameters:

- The details identified in the table above for the following items must be followed for the selected concealed overhead closer, and is based on the tested arrangements:
 - Frame option(s).
 - Permitted configuration(s).
 - The frame must be fitted with a head stop of the minimum size, where required.
 - Intumescent protection to the concealed closer.
 - Leaf perimeter intumescent details.
- It must be ensured that the concealed overhead closer is of sufficient strength and power to ensure the door leaf/leaves fully engage into the frame reveal.
- The dimensions of the concealed overhead door closer must not exceed the dimensions given within the tables above.

10.7.4 Floor Spring Self Closing Device

Based on the test evidence the following floor springs in conjunction with their tested pivot set are permitted for use with the doorset design subject to the following parameters:

- The details identified in the tables below for the following items must be followed for the selected floor springs, and is based on the tested arrangements:
 - Frame option(s)
 - Permitted configuration(s)
 - Leaf perimeter intumescent details.
 - Intumescent protection to the pivot set.
- It must be ensured that the floor spring closer is of sufficient strength and power to ensure the door leaf/leaves fully engage into the frame reveal.
- The dimensions of the floor spring door closer must not exceed the dimensions given within the tables below where identified.
- Transom overpanels or fan lights are not permitted.

Permitted Frame Option (Test evidence)	Permitted Configuration	Perimeter Intumescent Specification (see section 4.5)
1 (RF02018 Rev A) (WF379041)	DASD DADD	B/18 & G/18 plus additional 10mm x 4mm x 130mm long Pyroplex fitted alongside each edge of the top pivot (2No. per top pivot) in frame reveal B/19, G/19
1, 2 (FRR-2102/4628A)	DASD DADD	B/30 & G/30 except that additionally 2No. 15mm x 4mm LP1504 must be fitted centrally and 8mm apart to the bottom edge of the leaf.
1, 3 (WF509421)	DASD DADD	B/15 & G/15 except that additionally 1No. 25mm x 4mm LP2504 must be fitted centrally to the bottom edge of the leaf.
1, 2 (FRR-2009/2351)	DASD DADD	B/26 & G/26

The floor spring self closing devices with their associated pivots detailed in the following sections have been successfully tested with the Prima 60 door blank.

Test Evidence	Items	Hardware Intumescent Protection
WF509421	Halspan Limited 9300 floor spring – power size 4 9300 pivot set	Halspan 9300 pivot set intumescent kit 2mm graphite under top pivot forend, mortice for top strap, and mortice for bottom strap
	Halspan Limited 6300 floor spring – power size 3 6300 pivot set	Halspan 6300 pivot set intumescent kit 2mm graphite under top pivot forend, mortice for top strap, and mortice for bottom strap
RF02018 Rev A	Dorma BTS80F floor spring Dorma top strap, bottom strap and top pivot <ul style="list-style-type: none"> • Floor Spring: 341mm long x 60mm high x 78mm wide • Top strap: 335mm long x 80mm wide • Bottom strap: 235mm long x 25mm wide • Top pivot: 130mm long x 35mm wide 	2mm Dorma Graphite protection kit around top strap, pivot and bottom strap
WF379041	Dorma BTS75R Dorma top centre 8066, and top and bottom straps (of 235mm long) Floor Spring: <ul style="list-style-type: none"> • Foreplate: 285mm long x 105mm wide x 1.5mm deep • Body: 275mm long x 82mm wide x 50mm deep 	2.5mm Dorma Interdens® gasket set to all faces of mortices in leaf and frame for top centre and top and bottom straps.

Based on the test evidence the above the tested floor spring closers are permitted for use with the doorset design.

Alternatively, components with the following specification are deemed acceptable.

- Certifire approved floor spring self-closers with their specific associated pivot systems for 60-minute fire resistance applications on 54mm thick timber door and timber frames, providing the Certifire certificate is followed entirely.

10.7.5 Concealed Transom closer

Based on the testing listed within this section, these items are suitable in the following applications only:

Frame option: 1, 3

Configurations: DASD, DADD - Transom overpanels or fan lights are not permitted.

The door leaf must be lipped on all edges with hardwood as detailed in section 5.3.1.

When fitting concealed transom closers with their associated pivots the below specifications for the frame and perimeter intumescent must be met.

Permitted Frame Option (Test evidence)	Minimum frame cross section dimensions	Perimeter Intumescent Specification (see section 4.5)
1 (WF504390)	The head of the frame shall be no less than 125mm (d) x 68mm (h)	B/10 & G/10 except that additionally 2No. 15mm x 4mm Pyroplex 8700 must be fitted centrally and 10mm apart to the bottom edge of the leaf.
1, 3 (WF509420)		B/1 & G/1 except that additionally 1No. 25mm x 4mm LP2504 must be fitted centrally to the bottom edge of the leaf.

The concealed transom closer detailed in the following sections has been successfully tested with the Prima 60 door blank and is therefore suitable for use within the scope stated herein.

Test Evidence	Items	Hardware Intumescent Protection
WF504390 WF509420	Dormakaba - Transom closer: <ul style="list-style-type: none"> RTS80EMB power size 4 Foreplate: 360mm long x 108mm wide x 3mm deep Body: 314mm long x 70mm wide x 58mm deep <ul style="list-style-type: none"> RTS87 EN1-4 RTS87EMB power size 4 Foreplate: 320mm long x 108mm wide x 3mm deep Body: 265mm long x 72mm wide x 51mm deep Fitted with Dormakaba: <ul style="list-style-type: none"> Top strap 8530 Bottom pivot 7475AX / 7475 Bottom Strap 7421 	Dormakaba RTS87/RTS80 intumescent kit comprising: <ul style="list-style-type: none"> 2mm graphite to body and under plate of Transom Closer 2mm graphite to top pivot 2mm graphite to top strap 1mm Interdens® to mortice bottom strap and 2mm x 175mm x 21mm Interdens® to visible face of bottom strap Floor pivot - None

10.8 Bolts

10.8.1 Flush Bolts

The table below details a selection of the tested flush bolts that are approved.

Product Reference (Test evidence)	Size (mm)
Newstar FB200 (F14095)	203x38x19
Halspan – LCK-MS-C-205 (CFR1909241)	203x38x19
Carlisle Brass (sunk slide) AA79CP (RF13167)	101x17x3
Hafele 911.62.335 (FRR-2110/1498)	151x19x34
Simplex SDB 108 dust proof socket SDS 101 (FRR-2102/4628A)	200x19
Zoo Flush bolt (F16037)	200x20

The testing included a Woodex frame (F16037) and Hardwood and Beech frames.

In addition to the tested and permitted flush bolts detailed above, flushbolts which meet the following requirements are permitted.

- Flush bolts must be steel.
- The following maximum dimensions are not exceeded:
 - 203mm long x 20mm deep x 38mm wide.

On the basis of the testing, the tested and alternative flush bolts are suitable in the following applications only:

Frame options: All frame types

Configurations: LSADD (Optionally ULSADD & DADD)

In all cases the following scope must be complied with:

- Flush bolts must be fitted centrally within the thickness of the secondary leaf at the meeting edge.
- Flush bolts may be fitted to only the top of the leaf or alternatively to both the top and bottom of the leaf.
- The components are fitted relative to the meeting edge intumescent strips in one of the following ways:
 - Opposing the leaf edge fitted with intumescent strips such that no interruption occurs in either leaf (primary or secondary).

- Where there are intumescent strips fitted to both the primary and secondary leaf meeting edges a minimum of 2No. intumescent strips shall be in the leaf opposing the flush bolt.
- Intumescent Protection: All edges of the mortice of the keep and body must be protected with intumescent gaskets as specified in section 10.2.
- Flush bolts fitted at the bottom of the leaf cannot be used when a morticed in drop seal is present.
- The above flush bolts are not permitted in conjunction with equal rebated meeting edges or rebated flush overpanels.
- The mortice to facilitate the flush bolt must be as tight to the mechanism as is compatible with its operation and the inclusion of intumescent protection.

10.8.2 ANSI Z005 Automatic Flush Bolt

The table below details the tested automatic flush bolt that is approved.

Manufacturer & Product Reference	Overall Size of Product (mm)	Intumescent
ANSI – Z005 Auto (WF508198 B)	Lock case 190x50x30 Top and bottom plate 218 x 27 x 2 Meeting edge plate 215x25x3	2(t) Interdens® around the lockcase, Top & bottom end plate and forend plate

On the basis of the testing, the ANSI Z005 is suitable for use within the following scope:

Frame options: 1

Configurations: LSADD (Optionally ULSADD & DADD)

In all cases the following scope must be complied with:

- The ANSI Z005 must be fitted centrally within the thickness of the secondary leaf at the meeting edge.
- The ANSI Z005 may be fitted to only the top of the leaf or alternatively to both the top and bottom of the leaf.
- The ANSI Z005 must be fitted relative to the meeting edge intumescent strips in the following way:
 - Intumescent strips must be fitted to both the primary and secondary leaf meeting edges and a minimum of 2No. intumescent strips shall be in the leaf opposing the ANSI Z005.
- The Intumescent protection must be as tested and identified within the table above.
- ANSI Z005 bolts fitted at the bottom of the leaf cannot be used when a morticed in drop seal is present.
- The above ANSI Z005 is not permitted in conjunction with equal rebated meeting edges or flush overpanels.

- The mortice to facilitate the flush bolt must be as tight to the mechanism as is compatible with its operation and the inclusion of intumescent protection.

10.8.3 Surface Mounted Face Fixed Bolts

The table below details a selection of the tested surface mounted face fixed bolts that are approved.

Frame options: All frame types

Configurations: All configurations

Manufacturer & Product Reference (Test evidence)
<ul style="list-style-type: none">• Halspan Limited – BLT-BZA-100 (CFR2211141)
<ul style="list-style-type: none">• Royde & Tucker - Barza bolt B151-300-220 (CFR1809241)
<ul style="list-style-type: none">• Royde and Tucker – Barza B151-200-220 (CFR 2004171)
<ul style="list-style-type: none">• Carpenters Supply Co surfaced mounted 143C (RF 07141)

In addition to the above summarised tested surface mounted face fixed bolts, alternative surface mounted face fixed bolts constructed from steel, stainless steel, aluminium or bronze may be fitted, providing the dimensions are no greater than:

- 350mm long x 38mm wide (footprint).

Surface mounted face fixed bolts may be applied to the horizontal or vertical edges of the doorset providing the components are fitted at least 40mm from the corners of the leaf.

Intumescent protection is not required where both the bolt and keep are face fixed.

Where a keep is required to be recessed into the frame (as tested in CFR1808311), the keep shall be protected with 1mm (t) graphite based intumescent.

10.8.4 Flush Bolts with rebated meeting edges

The table below details the tested flush bolt that is approved with rebated meeting edges.

Frame options: 1, 2

Configurations: LSADD (Optionally ULSADD)

Successful test FRR-2010/2942 included flush bolts fitted within an equally rebated meeting edge. The flush bolts were fitted to the top and bottom of the leaf.

The table below details the tested flush bolt that is approved.

Manufacturer & Product Reference (Test evidence)
<ul style="list-style-type: none">• Eurolever SS1932 with SS1934 dust proof socket (FRR-2010/2942)

In addition to the tested and permitted flush bolt detailed above, flushbolts which meet the following requirements are permitted.

- Flush bolts must be steel.
- The following maximum dimensions are not exceeded:
 - 225mm long x 20mm deep x 22mm wide.

On the basis of the testing, the tested and alternative flush bolts are suitable in the following applications only:

In all cases the following scope must be complied with:

- Flush bolts fitted within rebated meeting edges shall not be applied when it is required to remove timber from the upstand of the rebate to facilitate their application.
- Flush bolts may be offset by a maximum of 11mm from the centreline of the door thickness to the centreline of the forend. This is based on successful testing undertaken in FRR-2010/2942 which included an offset flushbolt and a rebated meeting edge.
- Flush bolts may be fitted to only the top of the leaf or alternatively to both the top and bottom of the leaf.
- Intumescent Protection: All edges of the mortice of the keep and body must be protected with intumescent gaskets as specified in section 10.2.
- Flush bolts fitted at the bottom of the leaf cannot be used when a morticed in drop seal is present.
- The above flush bolts are not permitted in conjunction with flush overpanels.
- The mortice to facilitate the flush bolt must be as tight to the mechanism as is compatible with its operation and the inclusion of intumescent protection.
- Perimeter intumescent seals:
 - Intumescent Specification Reference F/19, G/19 and F/25 (see section 4.5)

10.8.5 Royde & Tucker Anza surface mounted bolt

ANZ-220-FD has been successfully tested in WF504819 with the bolt activator in the face of the leaf, and is suitable for use within the following scope:

- Frame: 1, 3 & 4 only
- Door configuration: LSADD, ULSADD
- Intumescent protection:
 - (a) 1mm thick interdens – Fitted to all sides of the mortice in the leaf face, under the guide plate in the leaf head and under the bolt keep in the frame head. This is supplied with the bolts from Royde & Tucker.
 - (b) Minimum of 2No seals of minimum size 15mm x 4mm, fitted 10mm apart centrally in the frame reveal.
- The rebate in the leaf face for the operating handle must not be closer than 190mm to the top or bottom of the leaf or closer than 40mm to the meeting edge of the leaf.
- The bolt fitted at the bottom of the leaf cannot be used when a morticed in drop seal is present.
- The longer length product variants ANZ-300-FD, ANZ-600-FD and ANZ-900-FD are also permitted as the bolt activator will be located further away from the top and bottom of the door leaf.

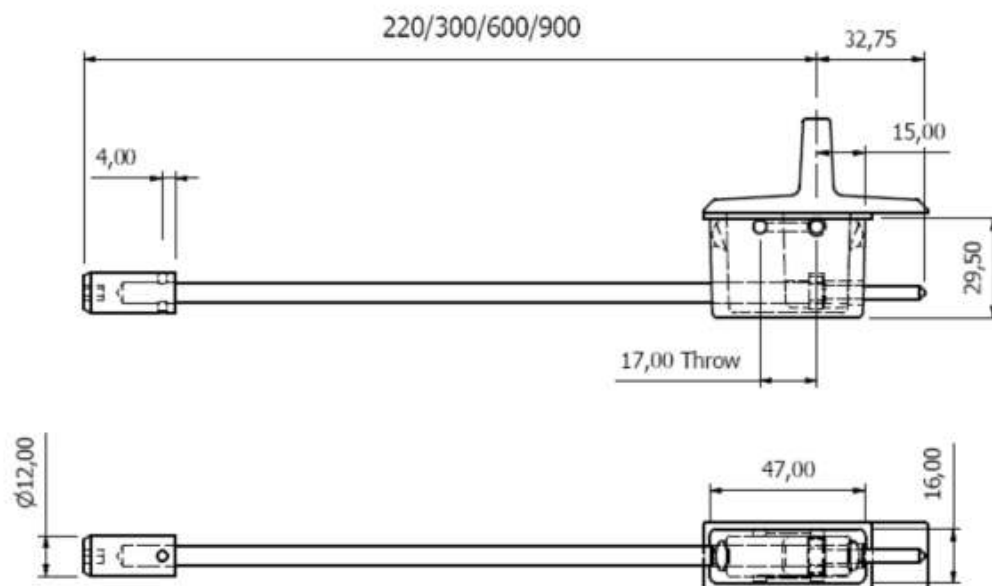

10.8.6 Royde & Tucker Anza flush mounted bolt

ANZ/R-300-FFD has been successfully tested in WF504819 with the bolt activator in the meeting edge, and is suitable for use within the following scope:

- Frame: 1, 3 & 4 only
- Door configuration: LSADD, ULSADD
- Intumescent protection:
 - (a) 1mm thick interdens – Fitted to all sides of the mortice in the leaf edge, under the guide plate in the leaf head and under the bolt keep in the frame head. This is supplied with the bolts from Royde & Tucker
 - (b) Minimum of 2No seals of minimum size 15mm x 4mm, fitted 10mm apart centrally in the frame reveal.
- The rebate for the operating handle recessed into the leaf edge must not be closer than 170mm to the top or bottom of the leaf and must be positioned centrally in the leaf edge.
- The bolt fitted at the bottom of the leaf cannot be used when a morticed in drop seal is present.
- The longer length product variants ANZ/R-600-FFD and ANZ/R-900-FFD are also permitted as the bolt activator will be located further away from the top and bottom of the door leaf.
- The shorter length product variant ANZ/R-220-FFD is also permitted on the basis that the fire resistance performance has been demonstrated on the longer product variant as well as the fact that the doorset design has been proven with flush bolts which interrupt the leaf edge further than required within the ANZ/R-220-FFD.

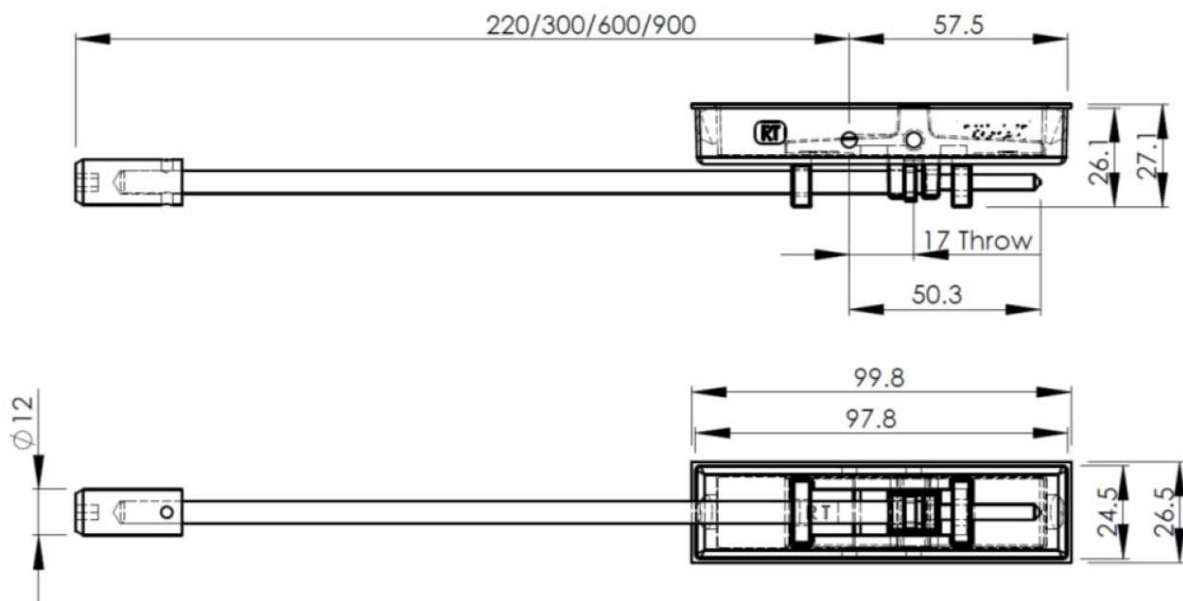

10.9 Cable Loops & Cableways

Where cable ways are required within the doorset design no recessing of frame or leaf is permitted except the item of hardware and the inclusion of a single hole to facilitate cabling which is no greater than Ø10mm. The hole must be abutting the element of hardware which it is required to facilitate and is only permitted when the frame to which the leaf is hung is adjacent to the supporting structure.

10.9.1 Cable Loops

The table below details the tested and assessed cable loops that are approved.

Test Evidence (Tested configuration)	Item & dimensions (mm)	Hardware Intumescent Protection	Minimum Perimeter Intumescent (Specified in Section 4.5)
CFR2004171 (LSADD) WF523824/R (LSASD)	Dormakaba KU260 Forend 290 long x 24 wide	SLS-PAD-113 1mm mono-ammonium phosphate to all concealed faces of cable loop body and to base of inside	2No. 15mm wide x 4mm thick seals fitted centrally within the frame reveal 10mm apart. Intumescent seal specification shall meet the criteria given in the text below this table and correspond to the intumescent permitted in section 4.5.
WF415117 (LSASD)	Gianni Industries Inc DL-500 Forend of body 292.5 x 25	1mm Interdens® to all concealed faces of cable loop body	
	Gianni Industries Inc DL-417ST Forend of body 290 x 24	1mm Interdens® to all concealed faces of cable loop body	
CFR2211141 (LSADD) WF508668 (LSASD)	Assa Abloy EA280 Body 324 x 24	SLS-PAD-113 1mm mono-ammonium phosphate based intumescent to all concealed faces of cable loop body or 2mm MAP to all concealed faces of cable loop body	
WF364240 (LSASD)	Abloy OY EA281 Body 543 x 24 wide x 22 deep	Bedded on 2mm of Interdens®	

Based on the test evidence, which was all conducted with Prima 60 in conjunction with Hardwood frames, the above tested and assessed cable loops are permitted for use with the doorset design subject to the following parameters:

Frame option: 1

Configurations: LSASD, ULSASD, LSADD, ULSADD

- When a cable loop is fitted, the leaf perimeter edge intumescent must be located into the frame reveal along the hanging edge.
- In all instances the location of the bottom of the cable loop body forend must be between 400–1100mm from the floor level.
- Intumescent protection to the cable loop used must be as tested and identified within the table above.
- The cable loop body may be rebated into the leaf edge or alternatively the frame reveal, in both instances the positioning shall remain central to the thickness of the leaf.
- When the cable loop body is rebated into the frame reveal, the frame intumescent must be one of the following tested intumescent seals when using one of the identified cable loops:
 - Halspan SLS
 - Pyroplex
 - STS

10.9.2 Cableways

Cableways through the leaf have been tested and are therefore permitted in the 4 methods detailed in the following sections in conjunction with the cable loops in section 10.9.1.

Cableways are only permitted at the perimeter of a glazed aperture in a leaf when fitted as detailed in Method 4 (Section 10.9.2.4). Except when reaching a glazed aperture at a perpendicular angle to the glazed aperture, cableways must be a minimum of 80mm from any apertures within the leaf e.g. glazing, air transfer grilles or letter plates etc.

Grooves cannot be located within 100mm of any cableway.

10.9.2.1 Cableway Method 1

This item has been successfully tested in test reference WF523824/R with associated hardware. Cableway method 1 is therefore suitable for use within the following scope:

Configurations: LSASD, ULSASD, LSADD, ULSADD

Maximum Leaf Size: 2440mm (h)

- A hole drilled centrally through the leaf of maximum 10mm diameter.
- The cable for the electronic closing/latching mechanisms must be no more than 3.5mm smaller in diameter than the hole through the leaf unless wrapped in 1mm graphite intumescent.
- The cable must be PVC encased.
- The hole must be located no higher than 1100mm from the threshold.

10.9.2.2 Cableway Method 2

Method 2 comprises a 10mm high x 10mm wide horizontal channel through the full width of the leaf, central to the leaf thickness and is concealed with an infill of the leaf core material.

This method has been successfully tested in test reference CFR2211141 (Right Hand doorset) with associated hardware. Cableway method 2 is therefore suitable for use within the following scope:

Configurations: LSASD, ULSASD, LSADD, ULSADD

Maximum Leaf Size: 2440mm (h)

- The hole must be located no higher than 1100mm from the threshold.
- Groove the face of the door core with a 10mm wide channel to a depth of 5mm below the centre of the door core, 32mm deep into the core.
- Groove the same face with a second groove 30mm wide x 22mm deep, located centrally over the first groove.
- Fit a plug into the second groove 30mm wide by 22mm deep using Prima core. The plug should run the full length of the cableway and be bonded into place using PVA or PU adhesive.
- The door core can then be lipped and calibrated in the usual manner.
- Mortice out the for the lock and drill a 10mm hole through the lipping on the opposite edge.
- The cable must be protected with 1mm STS CablePro graphite intumescent wrap.

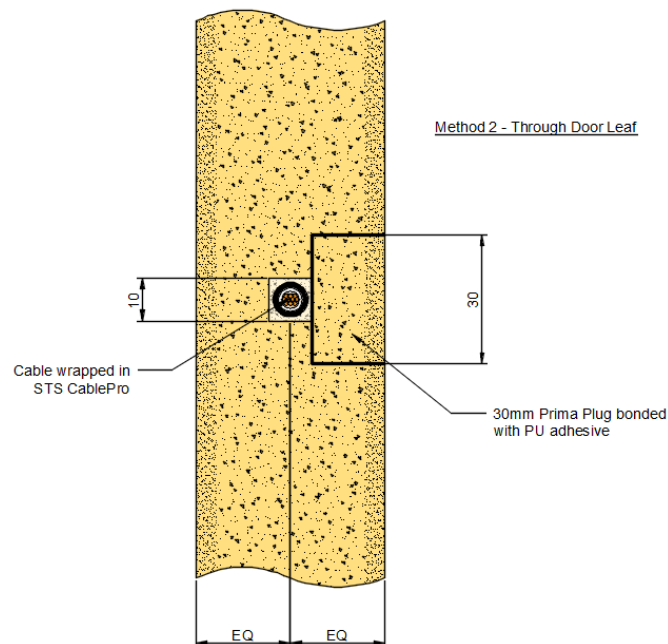

Cableway Method 2 detail – channel through centre of leaf thickness

10.9.2.3 Cableway Method 3

Method 3 comprises a 10mm high x 10mm wide channel central to the leaf edge, running down from the hanging edge to the bottom edge of leaf, along the bottom edge to the closing edge/meeting edge, and up along the closing edge/ meeting edge to the latch/lock location, and concealed with Sapele under the lippings.

This method has been successfully tested in test reference CFR2211141 (Right Hand doorset) with associated hardware. Cableway method 3 is therefore suitable for use within the following scope:

Configurations: LSASD, ULSASD, LSADD, ULSADD

- Groove the edge of the door core with a 10mm wide channel located centrally, to a depth of 39mm (prior to the fitting of lippings). This groove should run from the lock/keep location in the closing/meeting edge, down the edge, along the bottom of the door then back up the hanging edge to the cable loop location.
- Install the cable, protected with 1mm STS CablePro graphite intumescent wrap, into the groove.
- Infill the groove with 29mm x 10mm Sapele (minimum density 640 kg/m³), bonded in place with PU adhesive.
- When using cableway method 3, the door must be lipped on the bottom edge with a flat lipping of 6 to 12mm thick, and otherwise complying with the requirements of section 5.3.1.
- The door core can then be lipped and calibrated in the usual manner.

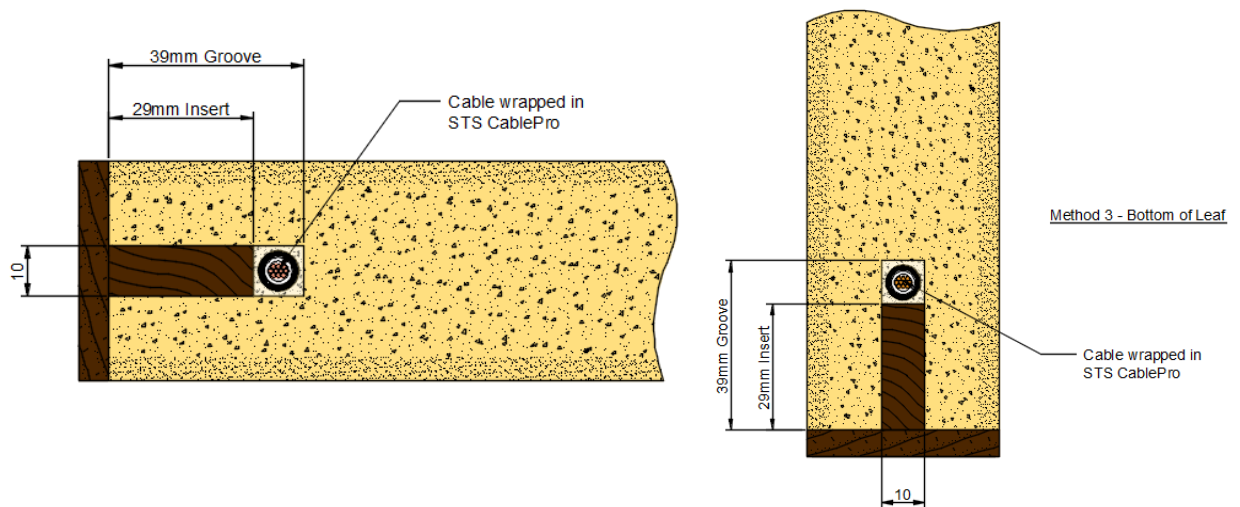

(A): Cableway Method 3 detail – channel through vertical leaf edges

(B): Cableway Method 3 detail – channel through bottom of leaf edge

10.9.2.4 Cableway Method 4

This method of routing a cable at the perimeter of a glazed aperture in a leaf is supported by the evidence detailed within WF523824/R.

This method shall only be utilised with Cableway Method 1 (Section 10.9.2.1).

Cableway method 4 is therefore suitable for use within the following scope:

Configurations: In line with Cableway Method 1 (Section 10.9.2.1)

Maximum Leaf Size: In line with Cableway Method 1 (Section 10.9.2.1)

- Apply the routing for the cableway through the leaf horizontally and perpendicular to the glazed aperture in accordance with method 1. The entry to the glazed aperture must be a minimum of 100mm away from glazing aperture corners.
- The glazed aperture may be routed with a maximum of 10mm wide x 10mm deep channel in the lower half of the aperture in the fashion of a 'U'. The channel must be central to the thickness of the leaf.
- The glazed aperture must be glazed with glazing system 5 as defined within section 6.3. Any of the associated glass types assessed for use with this glazing system are permitted.
- The following additional restrictions must also be followed:
 - The maximum aperture width permitted for use with this cable way is 352mm.
 - The maximum aperture height permitted for use with this cable way is 1792mm.
 - The glazing bead construction must be as defined for glazing system 5 however, the angle of application of the pins shall be 15 degrees to the face of the glass.
- The cable for the electronic closing/latching mechanisms must be no more than 3.5mm smaller in width and depth of the channel through around the lower half of the aperture unless wrapped in 1mm graphite intumescent.
- Setting blocks for the glazed aperture must span the width of the channel, without removal or compromise to the glazing system.

Below is a depiction of the permitted cableway – method 4:

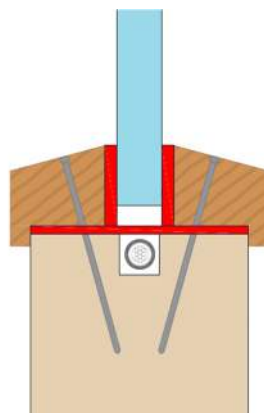

10.10 Pull Handles

The table below details a selection of the tested pull handles that are approved.

Manufacturer & Product Reference (Test evidence)
<ul style="list-style-type: none">Dorma UK Ltd ZP11 630 EP (WF390174)
<ul style="list-style-type: none">Zoo Hardware Ltd – ZAAD600BS (CFR2002051)
<ul style="list-style-type: none">Simplex VSP 2025 (FRR-2107/2288)
<ul style="list-style-type: none">Zoo Hardware ZAAD425BSA (WF 523941/R)

Alternatively pull handles must be Steel, stainless steel or bronze handles and may be surface-fixed or bolted through the door leaf, providing the length is limited to 1200mm between the fixing points. If through fixed, there must be no more than 1mm clearance between the hole and stud.

The above scope of application is provided as in the opinion of Warringtonfire they will not significantly affect the fire resistance performance of the doorset being considered. This is on the basis of the items being surface mounted away from the edge of the door leaf, therefore unlikely to influence the junction between door leaf and frame. Furthermore, they are generally of lightweight construction, meaning that they are unlikely to destabilise the doorset and therefore cause adverse deflection under test conditions. Lastly, the surface mounted arrangement of the features means no material is removed in terms of the overall thickness of the door leaf beyond the footprint of the item, therefore burn through of the leaf would not be expected.

10.11 Push Plates & Kick Plates

The table below details a selection of the tested push plates that are approved.

Manufacturer & Product Reference (Test evidence)
<ul style="list-style-type: none">Zoo Hardware Ltd – ZAS30RDSS (CFR2002051)
<ul style="list-style-type: none">Simplex – PPS-AE.150.1250 (FRR-2107/2288)
<ul style="list-style-type: none">Simplex - PPS-AE.100.400 (FRR 2102/4628A)
<ul style="list-style-type: none">Zoo Hardware – ZAA40CSA (WF523941/R)

Alternatively, components with the following specification are also deemed acceptable as in the opinion of Warringtonfire they will not significantly affect the fire resistance performance of the doorset being considered. This is on the basis of the items being surface mounted away from the edge of the door leaf, therefore unlikely to influence the junction between door leaf and frame. Furthermore, they are generally of lightweight construction, meaning that they are unlikely to destabilise the doorset and therefore cause adverse deflection under test conditions. Lastly, the surface mounted arrangement of the features means no material is removed in terms of the overall thickness of the door leaf beyond the footprint of the item, therefore burn through of the leaf would not be expected.

Approved specification:

- Polymeric or metal face-fixed hardware such as push plates and kick plates up to 2mm thick may be surface fitted to the doorset. These items of hardware are permitted up to a maximum of 20% of the door leaf area if mechanically fixed and a maximum of 30% if bonded with a contact or other thermally softening adhesive.
- Plates must not return around the door edges.
- Plates may not be recessed into the face of the leaf.
- In all cases plates meeting the above specification shall not be applied under glazing beads or door stops.

10.12 Back-to-back recessed pull handles

The table below details the tested back-to-back recessed pull handles that are approved.

Manufacturer & Product Reference (Test evidence)	Overall Size of Product	Recess in leaf	Intumescent
Zoo ZAS41 (WF526042)	90mm diameter x 19mm thick	71.5mm diameter x 18mm deep	1mm MAP to the rear of the flush pull handle
Zoo ZAS10 (WF526042)	102mm high x 51mm wide x 12mm thick	83mm high x 38mm wide x 10mm deep	None

On the basis of the testing, the tested steel recessed pull handles are suitable for use within the following scope:

Frame options: All

Configurations: All

- When required the Intumescent protection must be as tested and identified within the table above.
- The recessed pull handle must be located with the centre of the item between 500mm and 1700mm above the finish floor level and no closer than 100mm to a door edge and no closer than 100mm to glazing, cableways, grooves or any hardware.
- These items may be fixed in a back-to-back arrangement or with the recessed pull handle to one face and the push plate to the other face of the leaf, face-fixed with 18 to 20mm long screws and with a recess for the pull handle as tested.

10.13 Security Viewers

Up to 2no. viewers are permitted within an individual door leaf, viewers are to be positioned no closer than 60mm to door edges and no closer than 75mm to glazed apertures or any other hardware component.

The table below details tested security viewers that are approved, in all cases the tested viewers shall include the intumescent specification which has been proven within the doorset design.

Manufacturer & Product Reference (Test evidence)	Intumescent Protection
Halspan – DOR-VWR-100 (CFR2105131) (CFR2209201)	Halspan Limited SLS-PAD-127 50 x 1mm Graphite based intumescent lining the viewer aperture
Arrone Hoppe AR539-64PC (WF380315B)	0.6mm graphite intumescent sheet wrapped around the body
Glutz – GY3505.1PC (WF504819) (WF504821)	1mm thick graphite liner
Glutz UK Limited – GY3504.F (WF507671)	45mm x 40mm x 1mm S/A graphite
Durable – DV-200 (WB 112-1B&2B)	1mm Lorient Interdens®
Eurolever SS1945 (FRR-2010/2942, FRR-2009/1221)	Eurolever XX8002EV 1mm thick mono ammonium phosphate (MAP) self-adhesive around door viewer body in leaf

Alternatively, components with the following specification are also deemed acceptable.

- Door security viewers with brass or steel bodies of a diameter less than or equal to 15mm may be used provided that the through-hole is bored tight to the case of the viewer (maximum tolerance +1 mm). Lenses must be glass and the item must be protected with a tested acrylic intumescent mastic and / or a 1mm thick graphite based intumescent wrap.

10.14 Door Selectors

These items are suitable in the following applications only:

Configurations: All double leaf door configurations

These may be freely applied, provided that they are not invasive in the leaf edges or door frames and they do not interfere with the self-closing action of the door leaf. Products that are invasive are not considered within this field of application.

10.15 Air Transfer Grilles

The table below details the tested and therefore approved air transfer grilles within the doorset design.

Configurations: All configurations

Manufacturer & Product Reference (Test evidence)	Maximum Dimensions (mm)	Fixing Details	Intumescent Protection
Mann McGowan Pyrogrille 100 (WF391351)	598 w x 596 h	Fixings 75mm x 4.3mm drywall screws, nom 100mm from each corner applied through the vertical edges of the grille into the leaf.	Mann McGowan Pyromas A intumescent acrylic sealant. Cartridge gunned around the perimeter of each grille on both faces

In addition to the above detailed air transfer grille, it is possible to include a Certifire approved air transfer grille, which is approved for application in 60 minute fire resisting solid timber doorsets. In all instances the following specification must be followed:

- The aperture shall be lined with a hardwood (not Beech *fagus species*, minimum density 640kg/m³) aperture liner which is to be 6 - 8mm thick and adhered with PU or PVA adhesive and pinned with steel pins. The steel pins shall be positioned nominally 50mm from corners, no greater than 250mm centres and positioned centrally to the aperture liner.
- The air transfer grille must be fitted centrally to the leaf thickness.
- The size of any air transfer grille shall be no greater than 602mm high x 602mm wide or 0.36m².
- Air transfer grilles shall be rectilinear, other shapes are not permitted.
- Air transfer grilles shall be positioned such that the centre of the grille is 500mm ±200mm from the bottom of the leaf.
- Air transfer grilles shall not be closer than 200mm from the edge of the leaf or adjacent apertures within the leaf.
- It is possible to include a surface mounted ferrous or non-ferrous metal cover over the grille once installed providing it is applied with screws that are no longer than 20mm in length and when applied they are affixed into the leaf core material, i.e. not applied into the aperture liner or the grille itself.
- When a Certifire approved grille is utilised the full requirements of the Certifire certificate must be met in addition to the specification given above.
- The area occupied by the air transfer grille must be deducted from the area of glazing if both elements are fitted.
- Multiple apertures are permitted providing the maximum area of apertures is no greater than 1.25m².

10.16 Environmental Seals

A number of different environmental seals fitted to the upstand of the stop have been successfully tested as part of the Prima 60 doorset design, in conjunction with Beech, Hardwood and MDF Frames.

The table below details a selection of the tested environmental seals that are approved.

Manufacturer & Product Reference (Test evidence)
<ul style="list-style-type: none">Halspan Limited Triple Fin SLS-TRI (10mm x 10mm) (CFR2211141; WF520063)
<ul style="list-style-type: none">Durable Collection Ltd DS88 series (WB112-1B & 2B)
<ul style="list-style-type: none">LORIENT LAS1010 (10mm x 10mm) (FRR-2009/1221)
<ul style="list-style-type: none">LORIENT LAS 1212 (12mm x 12mm) (FRR-2110/1498)
<ul style="list-style-type: none">Schlegal Q-Lon Aquamac 21 (10mm x 13mm x 2mm) (CFR2006181)
<ul style="list-style-type: none">Halspan Limited Flipex (5mm x 16mm with 8mm exposed) (WF509420 & WF509421)

On this basis, silicone or PVC based flame retardant acoustic, weather and dust seals (for example those similar to the seals referenced above) may be fitted to this doorset design without compromising the performance, providing their fitting does not interfere with the activation of the intumescent seals or hinder the self-closing function of the leaves.

Where required, and on the basis that the Schlegal Q-Lon Aquamac 21 (10mm x 13mm x 2mm) has been tested in conjunction with a 54mm timber based doorset in test CFR2006181, the seals may be fitted rebated into the timber door stop or surface mounted with self-adhesive.

10.17 Threshold drop seals

10.17.1 Face mounted threshold drop seal

The table below details tested face mounted drop down seals that are approved to be face mounted at the bottom of one face of the door leaf.

Manufacturer & Product Reference (Test evidence)
<ul style="list-style-type: none">Norseal NOR820 900/S (CFR2103161)
<ul style="list-style-type: none">Lorient LAS8009 si (CFR2103161)

Tested and alternative aluminium face mounted threshold drop seals may be fitted subject to the following requirements:

- Face mounted threshold drop seal of maximum 62mm high x 22mm wide cross-sectional dimensions.
- Installation must not require the removal of any timber from the leaf, stop or frame reveal (except for screw fixing) and it does not interfere with the self-closing action of the door leaf.
- Screws to affix the threshold drop seal shall be no greater penetration into the leaf than 29mm long.
- 2No. 15mm wide x 4mm thick seals fitted 10mm apart centrally to the bottom edge of the leaf.

10.17.2 Rebated threshold drop seal

The table below details a selection of the tested rebated drop seals that are approved.

Manufacturer & Product Reference (Test evidence)
• Halspan – SLS-DRP (CFR2209201) – 35mm x 14mm
• EUROLEVER AS61000 (FRR-2010/2942) – 35mm x 14mm
• Lorient LAS8001 si (WB112-1B & 2B) – 35mm x 14mm

Alternatively, the following components are also deemed acceptable.

Product	Manufacturer
RP8Si	Raven Products Ltd.
NOR810, NOR810S	Norsound Ltd.
STS 422, STS422GT	Sealed Tight Solutions Ltd

Tested and alternative drop seals are permitted subject to the following:

- The tested and assessed rebated drop seals shall be fitted centrally within the leaf thickness at the bottom edge of the leaf.
- The rebated drop seal may be optionally protected with either one of the following arrangements:
 - 2No. 15mm wide x 4mm thick Halspan SLS seals to the bottom edge of the leaf fitted centrally and spaced either side of the drop seal.
 - Intumescent protection to the rebated threshold drop seal as detailed in section 10.2.
- If a rebated drop seal is fitted to the doorset then flush bolts, may not be fitted to the bottom of the doorset.

10.18 Letter Box / Plate

The table below details the tested letter plate that is approved.

Manufacturer, Product Reference & Intumescent Protection (Test evidence)
<ul style="list-style-type: none">Halspan TS008 Certified Letter plate – (CFR2209201) Aperture in leaf: 54mm x 260mm Intumescent: Halspan letterplate kit, comprising: 42mm x 6mm graphite to top and bottom of the letterplate aperture 25mm x 4mm graphite internally in the letterplate body 1mm graphite lining the fixing holes through the leaf.

The above letterplate is permitted subject to the following requirements:

- The area of the letter plate (and air transfer grille if present) plus any glazing must not exceed the total permitted area for apertures within the leaf.
- The letterplate shall be installed at a location of 800mm to 1400mm from the bottom of the leaf to the centre of the aperture and shall be no closer than 100mm to the edge of the leaf or any other apertures within the leaf.
- It is possible to install the above detailed letterplate within solid side panels providing the side panel is constructed from the same materials as the leaf and the positioning requirements given above are adhered to.

10.19 Knockers, Numerals & Signage

Components with the following specification are deemed acceptable as in the opinion of Warringtonfire they will not significantly affect the fire resistance performance of the doorset being considered. This is on the basis of the items being surface mounted away from the edge of the door leaf, therefore unlikely to influence the junction between door leaf and frame. Furthermore, they are generally of lightweight construction, meaning that they are unlikely to destabilise the doorset and therefore cause adverse deflection under test conditions. Lastly, the surface mounted arrangement of the features means no material is removed in terms of the overall thickness of the door leaf beyond the footprint of the item, therefore burn through of the leaf would not be expected.

Approved specifications:

Knockers:

- Steel, stainless steel, aluminium or bronze knockers, may be surface fixed or bolted through the door leaf, providing they are fitted no closer than 30mm from the leaf edge, other elements of building hardware or to any glazing and are no greater than 200mm high x 120mm wide. If through fixed, there must be no more than 1mm clearance between the hole and stud. It is only permitted to fit 1No. knocker to any one doorset.

Numerals & Signage:

- Steel, stainless steel, aluminium or bronze numerals or signage may be surface fixed to the door leaf, providing they are fitted no closer than 35mm from the leaf edge, other elements of building hardware or to any glazing. The dimension of each numeral or sign must be no greater than 200mm high x 100mm wide x 4mm thick. Up to 5No. numerals or signs may be applied to a doorset, numerals and signs may be applied adjacent to each other providing the 35mm from other elements as detailed above is maintained.

10.20 Security Chain

The table below details the tested security chain that is approved.

Manufacturer & Product Reference (Test evidence)
<ul style="list-style-type: none">Halspan LCK-CHN-100 (CFR2209201)

Components with the following specification are deemed acceptable as in the opinion of Warringtonfire they will not significantly affect the fire resistance performance of the doorset being considered. This is on the basis of the items being surface mounted with fixings positioned away from the edge of the door leaf and therefore unlikely to influence the junction between door leaf and frame. Furthermore, they are generally of lightweight construction, meaning that they are unlikely to destabilise the doorset and cause adverse deflection under test conditions. Lastly, the surface mounted arrangement of the features means no material is removed in terms of the overall thickness of the door leaf beyond the footprint of the item, therefore burn through of the leaf would not be expected.

Approved specification:

- Metallic security chains may be surface fixed to the face of the door leaf and frame, providing they are fitted such that they do not interfere with the junction between the leaf edge and the frame, and no material is removed in order to facilitate the fitting of the security chain. Screws to affix the security chain shall be no greater than 32mm long.

10.21 Fire Door Identification Plates

Plastic or metal fire door identification plates may be glued or screwed to the face of the door leaves providing they are fitted no closer than 35mm from the leaf edge, other elements of building hardware or to any glazing. The dimension of any applied plate must be no greater than 100mm high x 100mm wide x 3mm thick.

These may be required to identify the following:

- a) To be kept closed when not in use (Fire Door Keep Shut)
- b) To be kept locked shut when not in use (Fire Door Keep Locked Shut)
- c) Held open by an automatic release mechanism or free swing device (Automatic Fire Door Keep Clear).
- d) For compliance with HTM 58 (WF509420).

When applied to a door leaf the plate shall either be:

- surface mounted to the face without removing material from the leaf or
- fitted into a tight rebate into the leaf face such that it finishes flush with the leaf face

10.22 Panic Hardware

The table below details tested panic hardware that is approved when fitted at a height of 800mm to 1400mm from the floor.

Manufacturer & Product Reference (Test evidence)
<ul style="list-style-type: none">• Dorma GmbH & Co. KG – Dorma PHA 2500 panic exit device (WF198681) This item may be fitted in conjunction with a single or multi point latch/lock (section 10.4.1 or 10.4.2) and a lever handle (section 10.5). If a spindle hole is required, then the details given in section 10.5 must be followed.
<ul style="list-style-type: none">• Dorma UK Ltd – 9800 (Panic touch bar and Locking Rod Assembly) (WF513979) This item is limited to use on SASD configurations with a maximum leaf height of 2040mm.
<ul style="list-style-type: none">• Dorma UK Ltd – 9700 Series with ZT08/09 630 EP (Panic touch bar and Lever Trim with Europrofile adaptor) (WF390174)
<ul style="list-style-type: none">• Hoppe (UK) Ltd AR/TB 8802 with AR/TB 8805 (WF331430)

Alternative panic hardware may be fitted, providing the installation does not require the removal of any timber from the leaf, stop or frame reveal (except for screw fixing) and it does not interfere with the self-closing action of the door leaf.

The fitting of panic hardware is not considered to change the latching arrangement of the doorset and therefore the permitted leaf size shall be established using the appropriate doorset configuration based on the other latch/lock hardware fitted to the doorset.

10.23 Halspan Smart Tags

Based on the testing summarised within section 3, including WF509420 the following Near-Field Communication (NFC) devices as detailed below are permitted to be applied to the doorset within the following parameters:

Tested Specification:		
Manufacturer & Reference (Test evidence)	Material	Overall Dimensions
Halspan Limited, Halspan Edge Mounted Smart Tag: TAG-025-BLK (WF509420, WF509421, WF520064, CFR2211141 WF520063 & WF523824)	PVC	Ø25mm x 3mm thick
Halspan Limited, Halspan Surface Mounted Smart Tag: TAG-028-BLK (WF523824)	PVC	Ø28mm x 1mm thick

The following limitations must be adhered to when fitting the smart tag to the doorset:

Edge Mounted (Door leaf edge)

- The TAG-025-BLK or TAG-028-BLK smart tag must be fitted into a tight rebate such that the smart tag results in being flush with the lipping material.
- The TAG-028-BLK smart tag must be surface mounted onto the lipping material.
- The smart tags shall be applied within the hanging edge of the door leaf only.
- The smart tag shall be positioned centrally within the thickness of the door leaf.
- The smart tag shall be fitted no closer than 100mm below the top hinge position, measured from the centre of the tracker tag.
- The smart tag must be no closer than 87mm to any other element of hardware.
- It is not permitted to interrupt or remove intumescent material within the doorset to apply the above detailed tags.
- The smart tags shall not be applied over intumescent materials within the leaf edge but may be fitted opposing them.

Surface Mounted (Door leaf face)

- The TAG-025-BLK or TAG-028-BLK smart tag must be fitted into a tight rebate such that the smart tag results in being flush with the face of the leaf.
- The TAG-028-BLK smart tag must be surface mounted onto the leaf face without the removal of leaf material.
- The smart tags may be applied to the leaf face without restriction providing the tags meet the following limitations:
 - The smart tag shall not be applied such that it interfaces with the door stop.
 - The smart tag shall not be positioned directly above or on a glazed aperture.
 - The smart tag must be no closer than 87mm to any other element of hardware, apertures within the leaf or the edge of the leaf.

10.24 Overhead door operator

Frame option: 1

Configurations: LSASD, ULSASD, LSADD, ULSADD

The table below details the tested overhead door operator that is approved.

Manufacturer & Product Reference (Test evidence)
<ul style="list-style-type: none">• Dormakaba ED250, with slide arm (WF513979)

The tested overhead door operator must be installed with the body transom mounted on the closing face. The door must not be glazing with greater than 20% uninsulated glass.

Notes:

It must be ensured that the closer is of sufficient strength and power to ensure the door leaf/leaves fully engage into the frame reveal.

In the event of power failure it must be ensured that the door operator reverts to self closing function.

The Dormakaba ED250 overhead door operators and associated equipment should be supplied and fitted by the manufacturer or an approved agent to ensure compatibility and installation in accordance with the tested details.

10.25 Sensors

(to be used in conjunction with the Dormakaba ED250 overhead door operator)

The table below details the tested and approved sensors.

Manufacturer & Product Reference
<ul style="list-style-type: none">Dormakaba 294350 IRS-4 Infrared sensor 350mm (WF513979)
<ul style="list-style-type: none">Dormakaba 294110 IRS-4 Infrared sensor 1200mm (WF513979)
<ul style="list-style-type: none">Dormakaba Flatscan 4020009050 Kit LZR Flatscan SW + 3D left hand black (WF513979)

The tested sensors listed in the table above are suitable for use with the Prima 60 doorset design, subject to the following requirements:

- They must be face fixed to the leaf with screws no greater than 12mm long.
- A link cable is permitted when two sensors are fitted back-to-back on each face of the leaf. The through hole and link cable combination must comply with the following:
 - 7mm diameter hole with 4.25mm - 5mm diameter cable.
 - The through hole for the link cable must be lined with a minimum thickness of 0.6mm Interdens®
- The master cable for the Dormakaba IRS-4 is permitted to be mounted to the leaf face on the opposite face to the mounted sensor, as tested in WF513979. The through hole and cable combination must comply with the following:
 - 8.5mm diameter hole with 5.25mm diameter cable.
 - The through hole for the link cable must be lined with a minimum thickness of 0.6mm Interdens®
- Sensors and through holes must be no closer than 60mm to the edge of the leaf and no closer than 200mm to glazing apertures.

10.26 Roller Catches

The table below details the tested roller catches that are approved.

Manufacturer & Product Reference (Test evidence)
<ul style="list-style-type: none"> • Dorma – Dorma lock 332a (Rollerlatch lock) (WF 198681)
<ul style="list-style-type: none"> • Simplex SRL 750 (FRR-2102/4628A)

Alternatively, roller catches of the following specification are also deemed acceptable:

Element	Specification
Maximum forend dimensions	235mm high x 20mm wide x 4mm thick
Maximum strike plate dimensions (excluding tongue)	165mm high x 24mm wide x 4mm thick
Maximum body dimensions	165mm high x 81mm wide x 18mm thick.
Materials	All parts (including the roller, forend and strike) to be steel, stainless steel or brass with a melting point $\geq 800^{\circ}\text{C}$

Based on the test evidence the above tested and assessed roller catches are permitted for use with the doorset design subject to the following parameters:

Frame option: 1

Configurations: ULSASD, DASD, ULSADD, DADD

- When a roller catch is fitted a self-closing device must also be fitted.
- The minimum perimeter intumescent must be as follows:
- Single leaf doorsets: 2no. 15x4mm intumescent seals located into the frame reveal along the closing edge.
- Double leaf doorsets: 2no. 15x4mm intumescent seals located in the same leaf that the roller catch body is fitted in.
- Intumescent protection to the roller latch must be as detailed in section 10.2.
- Positioning must be no closer than 300mm from other meeting edge hardware.
- In all instances the location of the roller must be between 800 – 1500mm from the finished floor level.

10.27 Rain Deflector

The table below details tested face fixed rain deflector that is approved to be face mounted at the bottom of one face of the door leaf.

Manufacturer & Product Reference (Test evidence)
<ul style="list-style-type: none">Exitex Ltd – Deflector 20 reference 1.01.0110 (CFR2105131, CFR2006181)

Tested and alternative aluminium rain deflectors may be fitted subject to the following requirements:

- Rain deflectors of maximum 30mm high x 20mm cross-sectional dimensions.
- Installation must not require the removal of any timber from the leaf, stop or frame reveal (except for screw fixing) and it does not interfere with the self-closing action of the door leaf.
- Screws to affix the rain deflector shall be no greater penetration into the leaf than 24mm long.
- 2No. 15mm wide x 4mm thick seals fitted centrally to the bottom edge of the leaf.

10.28 Hold Open Armatures

Armatures for magnetic hold open devices have been tested in WF404075/A and achieved in excess of 60 minutes fire resistance performance. On this basis the following tested armature is permitted for use within the Prima 60 doorset design:

Manufacturer & Product Reference (Test evidence)
<ul style="list-style-type: none">Specialized Security, DR-01, Aluminium with Slim line magnet (WF404075/A)

Alternative hold open armatures may be fitted subject to the following requirements:

- Hold open armatures are to be constructed of metallic or polymeric construction.
- The maximum dimensions of 65mm high x 65mm wide shall not be exceeded.
- Installation must not require the removal of any timber from the leaf, stop or frame reveal (except for screw fixing) and it must not interfere with the self-closing action of the door leaf.
- Screws to affix the hold open armature shall be no greater penetration into the leaf than 24mm long.
- The hold open armature shall be positioned no further than 200mm from the top or bottom edge of the leaf and be positioned no closer than 60mm from the leaf edge or rebated hardware.

11 Installation

11.1 General

This section considers the installation of doorsets. This section considers:

- the door frame and architrave installation position relative to the wall
- the fire stopping between the frame and the wall
- the fixing requirement including packers
- the requirements for door edge gaps
- the trimming of door edges

11.2 Door Frame Installation

The following sub-sections provide tested and assessed acceptable door frame installations, which are dependent on the Frame type chosen.

11.2.1 Door Frame Installation – Frame 1, 2, 3 and 7



The following figures indicate the acceptable door frame installations. Please note that the firestopping element is provided in the below 3D models as a generic coloured seal. For further clarification of the approved firestopping systems see section 11.3.

This installation detail applies to all four sides of the 4-sided frame detailed in section 7.7.

Architraves requirements are documented in the firestopping section of this report.

11.2.1.1 Frame Fitted Flush to the Face of The Wall

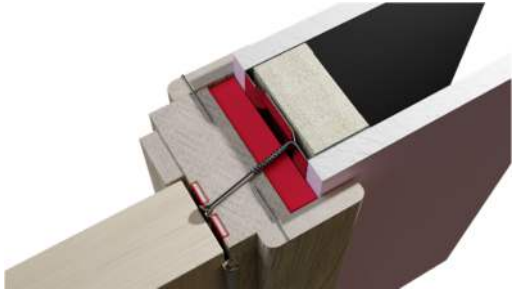
In all instances this installation detail assumes the frame construction is as detailed within section 7 for each respective frame type.

Permitted Installations	
	<p>Instances where the door frame and the wall of the same depth such that architraves may be fitted flush to both faces.</p> <p>Note that the minimum door frame section size (width and depth) must be as per the requirements noted in this report – see section 7.</p>
	<p>Instances where the wall thickness is greater than the door frame depth.</p> <p>In this scenario, architraves when applied, may be fitted to both faces. Where the architrave cannot physically overlap both the wall and the frame it is permitted to apply the architrave abutting the wall as depicted in the figure to the left.</p> <p>Note that the minimum door frame section size (width and depth) must be as per the requirements noted in this report – see section 7.</p>
	<p>Split frames are permitted providing that both frame sections are secured to the wall in accordance with section 11.5.</p> <p>Furthermore, the frame section to which the door leaf is hung must be constructed to at least the minimum door frame section size (width and depth) as per the requirements noted in section 7. The extension piece must be constructed using the one of the materials permitted for the construction of door frames.</p>

Note:

The drawings are provided as a generalised illustration of the door frame installation only; actual installation must be as per the text within this document specifies.

11.2.1.2 Frame Fitted Projecting the Face of The Wall (Leaf fitted within the thickness of the wall)

In all instances this installation detail assumes the frame construction is as detailed within section 7 for each respective frame type. In particular the requirement to offset each face of the leaf of double acting doorsets from each face of the wall, must be complied with.

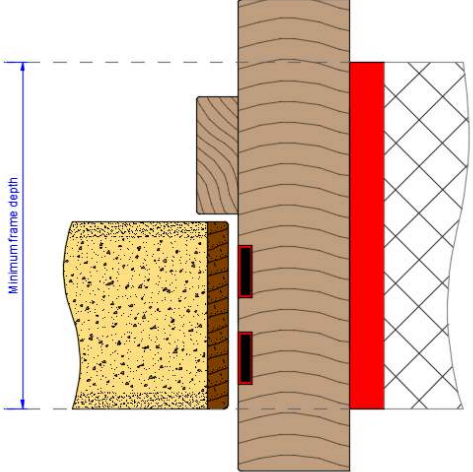
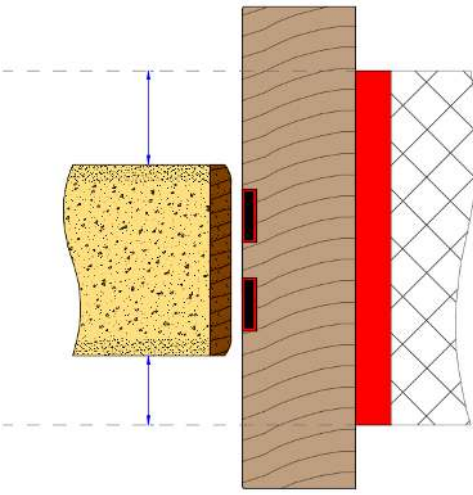
Permitted Installations	
	<p>Single Acting Arrangement</p> <p>Instances where the door leaf is fitted flush to wall face.</p> <p>The minimum door frame section size (width and depth) must be as per the requirements noted in this report – see section 7. And be positioned within the grey dotted section (shown left).</p>
	<p>Double Acting Arrangement</p> <p>Instances where the door leaf is fitted set back from each face of the wall as required in section 7 for each permitted frame type respectively. (shown left – in blue).</p> <p>The minimum door frame section size (width and depth) must be as per the requirements noted in this report – see section 7. And be positioned within the grey dotted section (shown left).</p>
<p>Split frames are permitted for single acting arrangements only, providing that:</p> <ul style="list-style-type: none"> • Both frame sections are secured to the wall in accordance with section 11.5. • The main frame section meets the minimum frame section sizes and projection as shown above is in excess of the minimum frame sizes. • The extension piece must be constructed using the same timber species as the main frame section. 	

Note:

The drawings are provided as a generalised illustration of the door frame installation only; actual installation must be as per the text within this document specifies.

11.2.2 Door Frame Installation – Frame 4

The installation is based on test reference CFR2211141 (Left Hand doorset).

The frame must be fitted with the two parts to wrap around the wall as shown, with the integral architraves fitting to the face of the wall.

The following figure indicates the acceptable door frame installation.

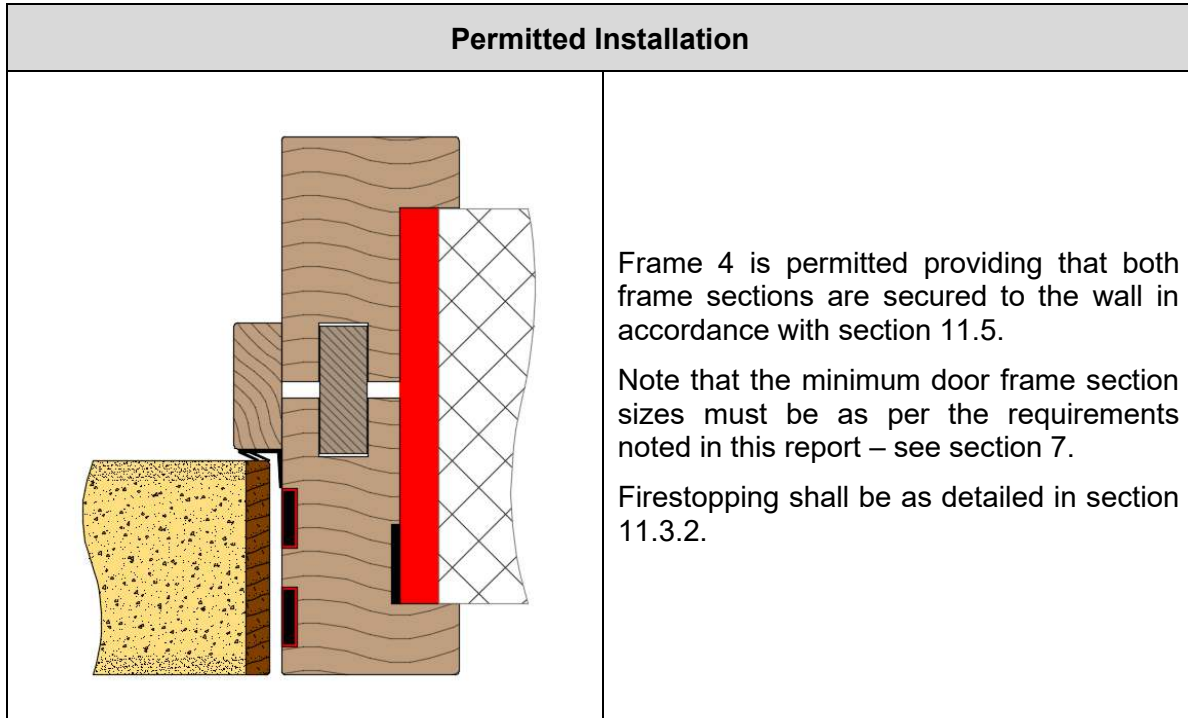

Note:

The drawing is provided as a generalised illustration of the door frame installation only; actual installation must be as per the text within this document specifies.

11.2.3 Door Frame Installation – Frame 5 – Projecting

The following figures indicate the acceptable door frame installations. Please note that the firestopping element is provided in the below 3D models as a generic-coloured seal. For further clarification of the approved firestopping systems see section 11.3.

Architraves requirements are documented in the firestopping section of this report.

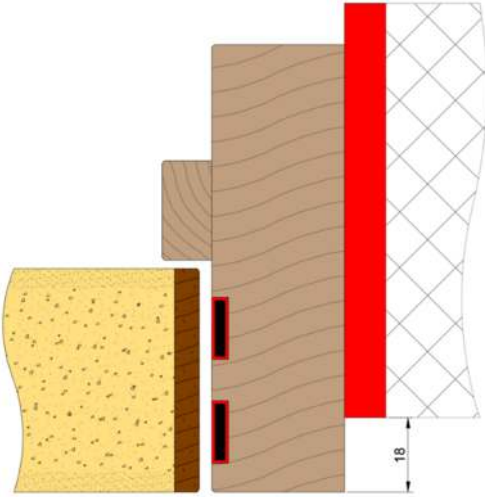
Permitted Installations	
	<p>The opening and / or closing face of the frame is permitted to project by a maximum of 18mm beyond the wall, based on CFR2211141 (Left Hand doorset).</p> <p>Note that the minimum door frame section size (width and depth) must be as per the Frame 5 requirements noted in this report – see door frame section.</p> <p>In this scenario, architraves when applied, may be fitted to the side of a frame which does not project from the wall. Where the architrave cannot physically overlap both the wall and the frame it is permitted to apply the architrave abutting the wall as depicted in the figure to the left.</p>

Note:

The drawing is provided as a generalised illustration of the door frame installation only; actual installation must be as per the text within this document specifies.

11.2.4 Door Frame Installation – Shadow gaps

11.2.4.1 General

The testing of frames with integral architraves (frame type 4) and projecting door frames (frame type 5) demonstrates that timber based frame types are capable of a degree of resistance to fire from the rear when the frame material protrudes beyond the face of the wall.

CFR2211141B, WF504819 and WF504821 tested frames featuring integral architraves which protruded into the furnace by 18mm, as did the face of the door leaves.

A specific shadow gap detail was also tested in WF508668 and WF508198. These tests provide evidence of the performance of the associated trims and intumescent protection for the shadow gap details listed within this section.

Based on the testing referenced above shadow gap details are permitted within the following parameters:

Frame: 1 and 3

- In all instances the frame must be as detailed below and otherwise to the specification in 7.1.1 and 7.3.1.
- This installation detail may be applied to all four sides of the 4-sided frame detailed in section 7.7 when utilised.

Configurations: LSASD, ULSASD, DASD, LSADD, ULSADD, DADD and permitted with the leaf sizes and intumescent specifications in section 4.5 unless other limiting factors need to be applied based on the use of specific items of hardware or installation methods (e.g. utilising a 4-sided frame where the intumescent requirements within section 7.7 must also be complied with).

The following sections outline the permitted shadow gap details which are considered by this assessment:

11.2.4.2 Shadow Gap – Option A

PVC/ALUMINIUM TRIM DETAIL

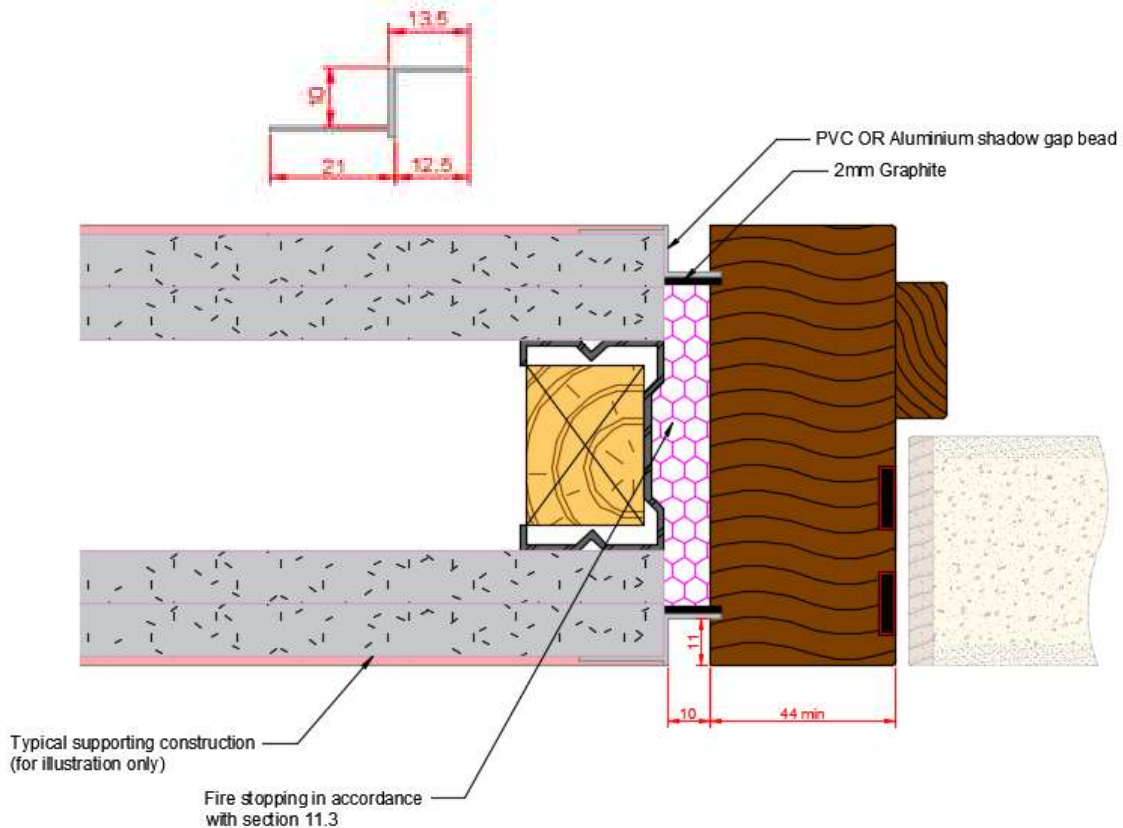

Permitted Specifications:

- The shadow gap is formed to the rear of the frame by a reduction in the depth of the fire stopping material and the application of a PVC / aluminium trim as depicted above.
- The overall dimensions of the PVC / Aluminium trim must be no greater than those depicted above except that the thickness of the item may be between 0.8mm and 1.5mm thick.
- It is permitted to groove the trim and associated intumescent (as required below) into the rear of the door frame by no more than 3mm.
- The PVC / aluminium trim must be protected by
 - 2mm thick graphite strip applied lining the rear of the trim material as depicted above.
- The intumescent must be fitted around the whole perimeter of the door frame.
- Minimum frame widths must be as defined below:
 - For single acting doorsets the minimum frame section width after any rebates have been taken out of the back of the frame must remain as 44mm.
 - For double acting doorsets the minimum frame section width after any rebates have been taken out of the back of the frame must remain as 54mm.
 - Where a minimum frame width / thickness is specified for a particular item of hardware (e.g. Concealed Transom Closer, Section 10.7.5.), in order to utilise shadow gaps, the minimum dimension provided in the hardware section must be increased by a minimum of 10mm.
- Fire stopping is carried out in accordance with section 11.3.4, as applicable for the shadow gap option.

11.2.4.3 Shadow Gap – Option B

PVC/ALUMINIUM TRIM DETAIL

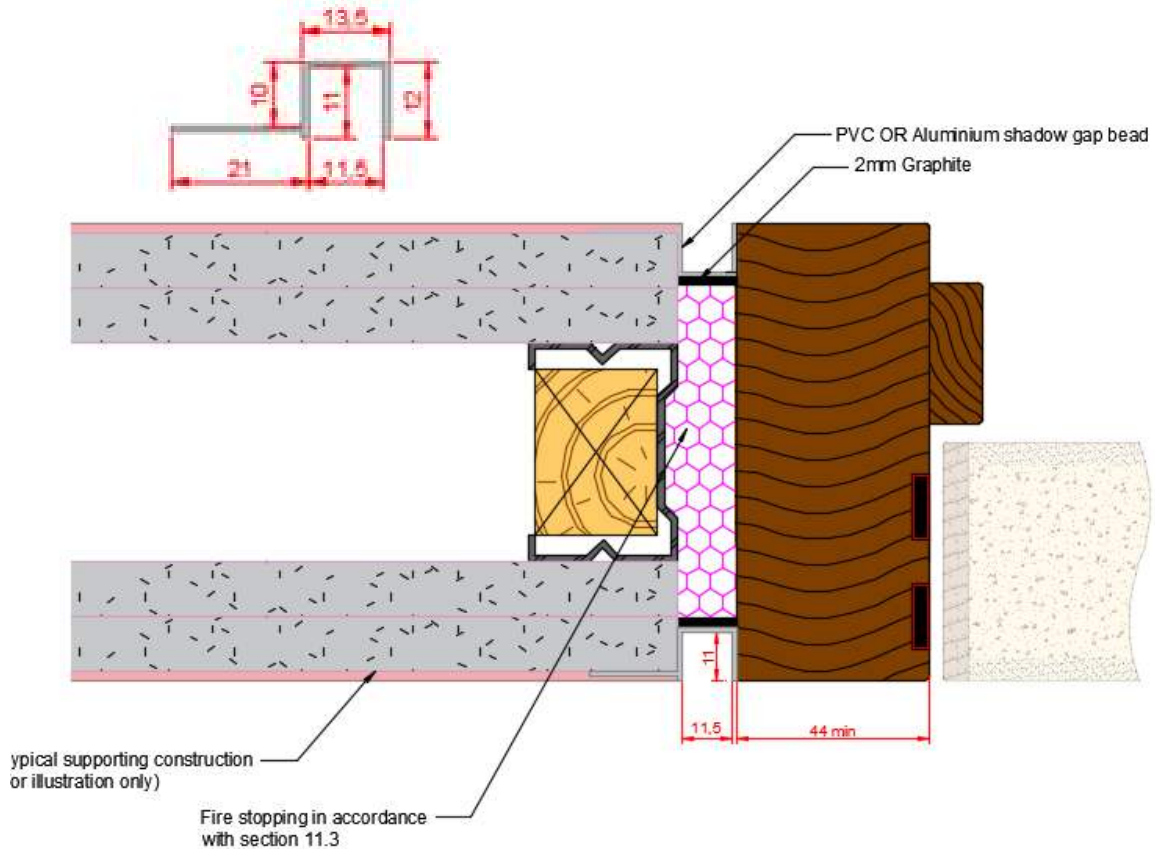

Permitted Specifications:

- The shadow gap is formed to the rear of the frame by a reduction in the depth of the fire stopping material and the application of a PVC / aluminium trim as depicted above.
- The overall dimensions of the PVC / Aluminium trim must be no greater than those depicted above except that the thickness of the item may be between 0.8mm and 1.5mm thick.
- The PVC / aluminium trim must be protected by
 - 2mm thick graphite strip applied lining the rear of the trim material as depicted above.
- The intumescent must be fitted around the whole perimeter of the door frame.
- Minimum frame widths must be as defined below:
 - For single acting doorsets the minimum frame section width after any rebates have been taken out of the back of the frame must remain as 44mm.
 - For double acting doorsets the minimum frame section width after any rebates have been taken out of the back of the frame must remain as 54mm.
 - Where a minimum frame width / thickness is specified for a particular item of hardware (e.g. Concealed Transom Closer, Section 10.7.5.), in order to utilise shadow gaps, the minimum dimension provided in the hardware section must be increased by a minimum of 10mm.
- Fire stopping is carried out in accordance with section 11.3.4, as applicable for the shadow gap option.

11.2.4.4 Shadow Gap – Option C

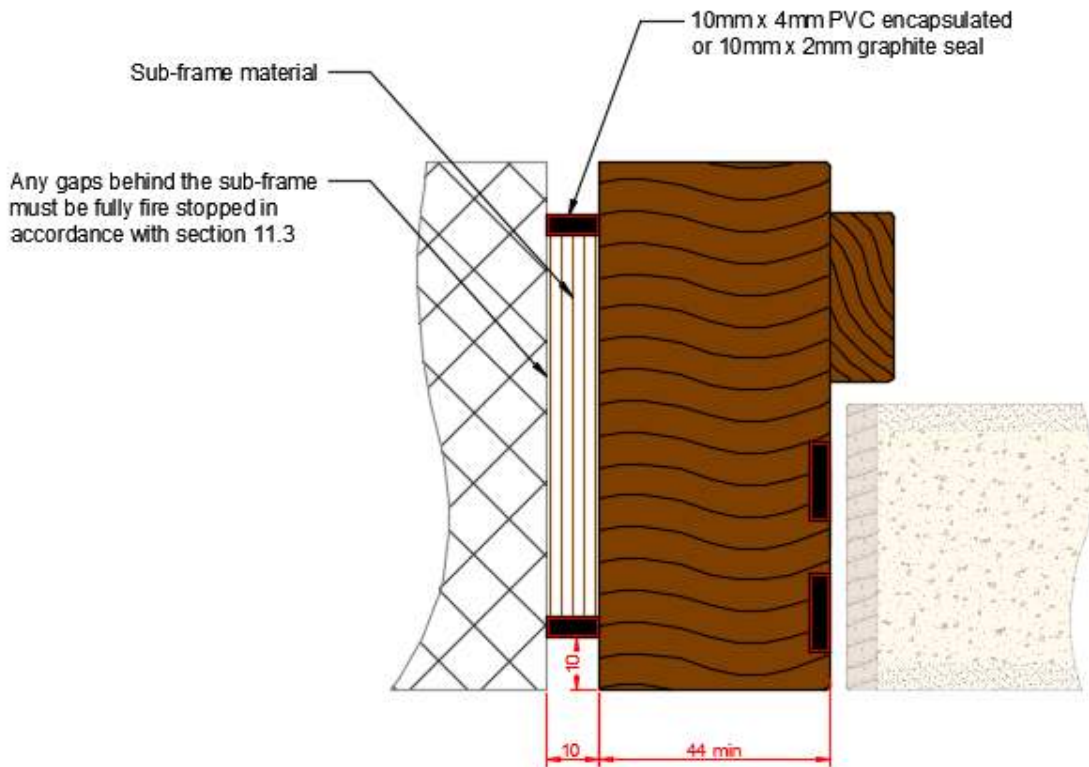

Permitted Specifications:

- The shadow gap is formed to the rear of the frame by the application of a sub-frame.
- Sub-frame materials must be formed from a single piece of material without joints across any single length, the permitted materials are:
 - Hardwood (excluding beech, Fagus species) with a density $>640\text{kg/m}^3$
 - Plywood with a density $>600\text{kg/m}^3$
 - MDF with a density $>700\text{kg/m}^3$
 - Particleboard with a density $>600\text{kg/m}^3$
 - Non-combustible board
- The sub-frame when applied must be fixed with steel screws appropriate for timber substrates. The screws must be applied through the sub frame into the rear of the door frame positioned at 100mm from ends and no greater than 350mm centres. Fixings must penetrate the rear of the frame by a minimum of 20mm. A twin line of fixings is optionally permitted. The joint must be additionally reinforced with PU or PVA adhesive.
- The shadow gap after the fitting of the required intumescent material is a maximum of 10mm wide x 10mm deep.
- The shadow gap must be protected by either:
 - a 10mm wide x 2mm thick graphite strip or
 - a 10mm x 4mm PVC encapsulated graphite seal
- The chosen intumescent must be fitted to the base of the shadow gap around the whole perimeter of the door frame (as depicted above).
- Minimum frame widths must be as defined below:
 - For single acting doorsets the minimum frame section width after any rebates have been taken out of the back of the frame must remain as 44mm.

- For double acting doorsets the minimum frame section width after any rebates have been taken out of the back of the frame must remain as 54mm.
 - Where a minimum frame width / thickness is specified for a particular item of hardware (e.g. Concealed Transom Closer, Section 10.7.5.), in order to utilise shadow gaps, the minimum dimension provided in the hardware section must be increased by a minimum of 10mm.
- Fire stopping is carried out in accordance with section 11.3.4, as applicable for the shadow gap option.

11.2.4.5 Shadow Gap – Option D

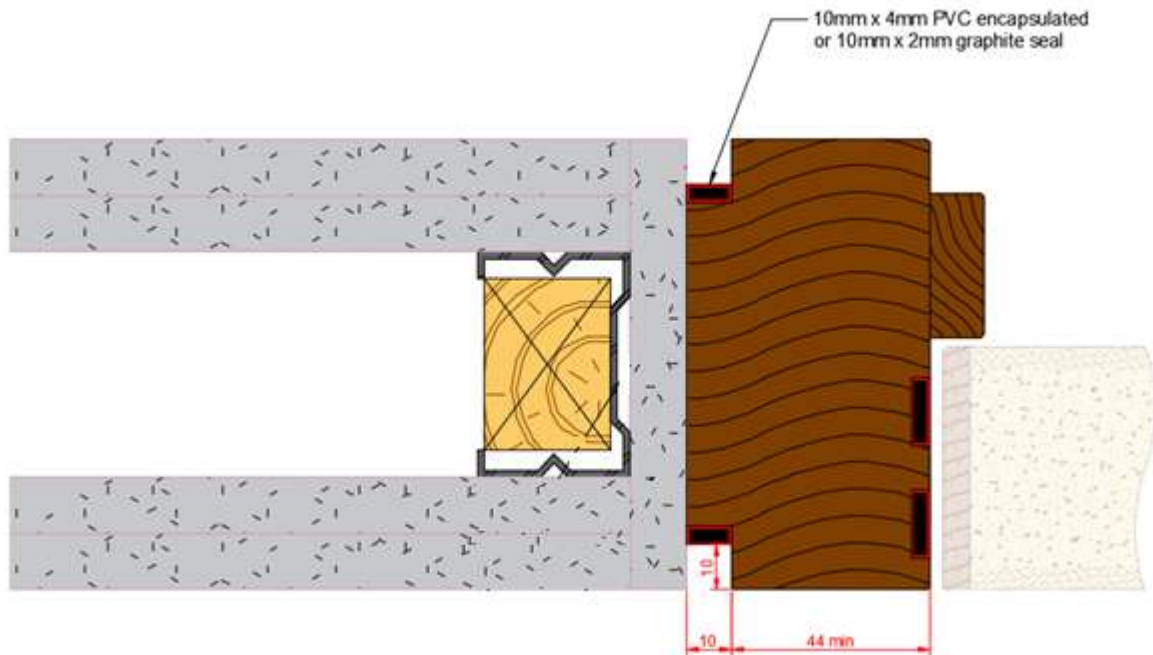

Permitted Specifications:

- The shadow gap is formed to the rear of the frame by rebating the frame by 10mm wide x a maximum of 14mm deep.
- The shadow gap after the fitting of the required intumescent material is a maximum of 10mm wide x 10mm deep.
- The shadow gap must be protected by either:
 - a 10mm wide x 2mm thick graphite strip or
 - a 10mm x 4mm PVC encapsulated graphite seal
- The chosen intumescent must be fitted to the base of the shadow gap around the whole perimeter of the door frame (as depicted above).
- Minimum frame widths must be as defined below:
 - For single acting doorsets the minimum frame section width after any rebates have been taken out of the back of the frame must remain as 44mm.
 - For double acting doorsets the minimum frame section width after any rebates have been taken out of the back of the frame must remain as 54mm.
 - Where a minimum frame width / thickness is specified for a particular item of hardware (e.g. Concealed Transom Closer, Section 10.7.5.), in order to utilise shadow gaps, the minimum dimension provided in the hardware section must be increased by a minimum of 10mm.
- Fire stopping is carried out in accordance with section 11.3.4, as applicable for the shadow gap option.

11.3 Firestopping

The following sub-sections provide tested and assessed acceptable door frame firestopping requirements which are dependent on the Frame type chosen.

11.3.1 Firestopping – Frame 1, 2, 3, 7

The firestopping requirements between the back of frame and wall are dependent on the gap size between the substrates. The table below provides the requirements based upon the gaps size. Please note that in the 3D depictions noted below show the application where a door frame is of the same depth as the overall wall thickness.

This installation detail also applies to all four sides of the 4-sided frame detailed in section 7.7.

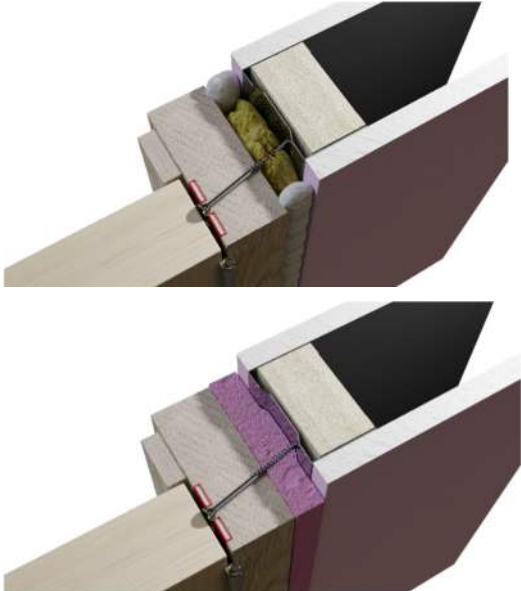
Gap (mm)	Requirement	3D model depiction
Up to 10	<p>Gap must be sealed on both sides with a 10mm depth of acrylic intumescent mastic, fire tested for this application to BS 476: Part 22: 1987 or BS EN 1634-1. If the evidence for the fire stopping used included architraves, they must be fitted as tested.</p> <p>Architraves may be fitted to both faces.</p>	
Up to 20	<p>Gap must be tightly packed with mineral fibre capped on both sides with a 10mm depth of acrylic intumescent mastic, fire tested for this application to BS 476: Part 22: 1987 or BS EN 1634-1 or full depth expanding PU foam, fire tested for this application to BS 476: Part 22: 1987 or BS EN 1634-1. If the evidence for the fire stopping used included architraves, they must be fitted as tested.</p> <p>Architraves may be fitted to both faces.</p>	

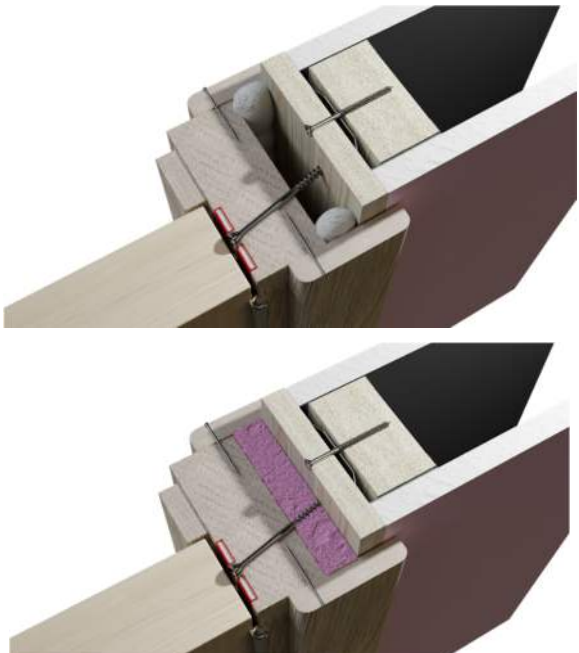
Gap (mm)	Requirement	3D model depiction
Over 20	<p>A timber based or non-combustible subframe up to 50mm thick x the depth of the frame can be inserted and fixed to the wall bedded on a continuous bead of intumescent mastic, the gap between door frame and subframe filled as follows:</p> <p>Subsequent gaps between the frame and the subframe of 5 to 10mm must be filled utilising one of the options given above.</p> <p>Architraves may be fitted to both faces.</p>	

11.3.2 Firestopping for Frame 4

When installing frame 4, the following firestopping must be used, based on test reference CFR2211141 (Left Hand doorset).

Gap (mm)	Requirement	Depiction
3 – 7	<p>Intumescent comprising 20 x 2mm ISL Therm-A-Flex is required to be recessed into the rear of the frame as shown.</p> <p>A 10mm depth of acrylic intumescent mastic, fire tested for this application to BS 476: Part 22: 1987 or BS EN 1634-1, must be applied as shown to the primary frame section before the installation of the secondary frame section.</p>	

11.3.3 Firestopping for Frame 5 – Projecting

The firestopping requirements between the back of frame and wall are dependent on the gap size between the substrates. The table below provides the requirements based upon the gaps size.

Gap (mm)	Requirement	Depiction
Up to 20	<p>Gap must be tightly packed with mineral fibre capped on both sides with a 10mm depth of acrylic intumescent mastic, fire tested for this application to BS 476: Part 22: 1987. If the evidence for the fire stopping used included architraves, they must be fitted as tested.</p> <p>Architraves may be fitted to both faces, when fitted.</p>	

11.3.4 Firestopping for shadow gap detail

When installing a shadow gap detail as detailed within section 11.2.4, the following firestopping must be used depending on the shadow gap option utilised.

11.3.4.1 Firestopping – Shadow Gap – Options A & B

The shadow gap options (A & B) as detailed within section 11.2.4.2 & 11.2.4.3 must utilise the following method of firestopping:

Gap (mm)	Requirement
Up to 13.5	Gap must be tightly packed with mineral fibre capped on both sides with a 10mm depth of acrylic intumescent mastic, fire tested for this application to BS 476: Part 22: 1987 or BS EN 1634-1. Architraves are not required.
Depiction	

Gaps greater than 13.5mm are not permitted.

11.3.4.2 Firestopping – Shadow Gap – Options C & D

The shadow gap options (C & D) as detailed within section 11.2.4.4 & 11.2.4.5 must utilise the following method of firestopping:

Gap (mm)	Requirement
Up to 3	Bedded on 2No. nominally Ø6mm continuous beads of acrylic intumescent mastic, fire tested for this application to BS 476: Part 22: 1987 or BS EN 1634-1. The beads must be set back 5mm from each face of the framing material. Architraves are not required.

Gaps greater than 3mm are not permitted.

11.4 Packers

Packers can be timber of equal density to the frame, or, MDF or plywood or plastic packers if fire tested for this application to BS 476: Part 22: 1987 or BS EN 1634-1.

Packers should be of a suitable size and set in place to allow the fire stopping materials to be applied over the top.

Packers should not be left exposed when architraves are not applied. Where packers are exposed, regardless of the packing material, they should be cut back at least 5mm and capped with tested intumescent mastic.

11.5 Wall Types, Structural Opening & Fixity

11.5.1 Wall Types

The following wall types are approved for this doorset design:

- a) Plasterboard clad timber stud partitions
- b) Plasterboard clad steel stud partitions including timber lining.
- c) Masonry constructions

Wall types a & b above must have supporting fire resistance test evidence which demonstrates that it is capable of staying in place and intact for a minimum of 60 minutes supporting a doorset design.

Wall type c above must be determined to be able to provide at least the same level of fire resistance of the doorset design.

All wall types detailed above shall provide a suitable medium to permit adequate fixity, it is anticipated that for:

- Plasterboard clad timber stud partitions, the timber stud will be of sufficient dimensions such that the fixing for the door frame penetrates into solid timber.
- Plasterboard clad steel stud partitions will include a timber lining of sufficient dimensions such that the fixing for the door frame penetrates into solid timber.
- Masonry constructions are anticipated to be constructed of a solid block or brickwork to receive the fixings.

Note: Other tested solutions to achieve adequate fixity may be detailed within the above noted supporting fire resistance test evidence.

11.5.1.1 Minimum wall thickness

For Frame 4, in addition to the requirements in section 11.5.1 the wall must be a minimum of 100mm thick.

When installed with the shadow gap detail in section 11.2.4, in addition to the requirements in section 11.5.1 the wall must:

- a) be a minimum of 100mm thick

11.5.2 Structural Opening

For all wall types the structural opening shall be square, plumb and provide a flat surface for installation of the doorset.

For flexible wall types such as steel and timber stud partitions the structural opening must be prepared in line with the test evidence provided by the wall manufacturer.

11.5.3 Fixity

In all instances the fixing position must be such that it provides adequate restraint to the element of construction throughout the exposure to fire. This may therefore sometimes necessitate a twin line of fixings.

For single leaf doorset without fanlights or sidepanels, the frame jambs only are to be fixed to the supporting construction using steel fixings at 600mm maximum centres and maximum of 150mm from corners. The fixings must be of the appropriate type for the supporting construction and must penetrate to a minimum depth of 50mm. It is not necessary to fix the frame head.

For all other configurations of doorset, the upper horizontal framing section abutting the structural opening (i.e. frame head on double doors) must also be secured to the wall using steel fixings at 600mm maximum centres and maximum of 150mm from corners. The fixings must be of the appropriate type for the supporting construction and must penetrate to a minimum depth of 50mm.

For split frames which include two elements (including extension liners), both sections of the frame shall be fixed to the supporting structure as detailed above.

11.6 Post Production (Onsite) Leaf Size Adjustment

The Prima 60 range of doorsets may be altered as follows:

Leaf Size Adjustment Specification	
Element	Reduction
Lipping	The post-production lipping thickness for flat timber based lippings may be reduced by 1mm for fitting purposes, providing that the door gaps and intumescent conditions remain as required by this assessment and the minimum limitation in terms of lipping thickness is still maintained. Otherwise, no modification can be made.

11.7 Door Gaps

Door gaps and alignment tolerances must fall within the following range:

Door Gap & Alignment Tolerance Specification	
Location	Dimension
Door edge gaps	A minimum of 2mm and a maximum of 4mm
Alignment tolerances	<p>Leaves must not be proud of each other or from the door frame by more than 1mm but may be fitted to sit back from the opening face by up to 2mm.</p> <p>The following specific requirement for Double Acting arrangements, take precedence:</p> <ul style="list-style-type: none"> Required set back distances given in section 7 must be complied with. <p>The following specific requirement for Single Acting arrangements (as considered in section 11.2.1.2), take precedence:</p> <ul style="list-style-type: none"> Leaves must not be proud of the wall face by more than 1mm but may be fitted to sit back from the opening face of the wall by up to 2mm.
<p>Threshold / Bottom edge of the leaf</p> <p>This is the maximum tolerance for fire resistance only.</p>	<p>8mm between bottom of leaf and top of floor covering.</p> <p>The following specific gap requirements, for designs as detailed in section 7, take precedence:</p> <ul style="list-style-type: none"> 4-sided timber frame with door stop (section 7.7): a minimum of 2mm and a maximum of 4mm between bottom of leaf and timber threshold. Hardwood timber threshold (section 7.8): 8mm between bottom of leaf and timber threshold. Aluminium threshold (section 7.9): 4mm between bottom of leaf and aluminium threshold at the opening side of the doorset.

12 Insulation Performance

Insulation performance may be claimed for a doorset to this design meeting the following:

Insulation Performance Criteria	
Type	Details
Non-insulating	Doorsets incorporating greater than 20% of non-insulating glazing
Partially insulating	Doorsets incorporating up to 20% of non-insulating glazing
Fully insulating	Unglazed doorsets or doorsets including 60-minute insulating glazing

13 Conclusion

If Prima 60 doorsets with timber-based frames constructed in accordance with the specification documented in this field of application were to be tested in accordance with BS 476: Part 22: 1987, it is our opinion that they would provide a minimum of 60 minutes integrity and insulation (subject to section 12).

14 Declaration by the Applicant

- 1) We the undersigned confirm that we have read and comply with obligations placed on us by the Passive Fire Protection Forum (PFPF) Guide to undertaking technical assessments and engineering evaluations based on fire test evidence 2021 Industry Standard Procedure
- 2) We confirm that any changes to a component or element of structure which are the subject of this assessment have not to our knowledge been tested to the standard against which this assessment has been made.
- 3) We agree to withdraw this assessment from circulation should the component or element of structure, or any of its component parts be the subject of a failed fire resistance test to the standard against which this assessment is being made.
- 4) We understand that this assessment is based on test evidence and will be withdrawn should evidence become available that causes the conclusion to be questioned. In that case, we accept that new test evidence may be required.
- 5) We are not aware of any information that could affect the conclusions of this assessment. If we subsequently become aware of any such information, we agree to ask the assessing authority to withdraw the assessment.

(In accordance with the principles of FTSG Resolution No. 82: 2001)

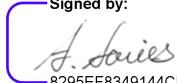
Signed:  Signed by:
8295EF8349144CB...

Name: Andy Davies

Position: Technical Manager

Date: 03-Dec-2025

For and on behalf of: **Halspan Limited**

15 Limitations

This assessment report:

- Does not provide an endorsement by Warringtonfire of actual products supplied.
- Has been prepared based on information provided by the Applicant. Warringtonfire has not verified the accuracy or completeness of that information and will not be responsible for any errors or omissions that might be incorporated into this report as a result.
- Any figures included in this report are provided for illustrative purposes only and may not fully reflect the actual scope being assessed. Warringtonfire cannot guarantee the accuracy of the drawings against the scope being assessed. The scope of this report is limited to assessments of the modifications to the tested systems as described herein.
- This report addresses itself solely to the elements and subjects discussed and do not cover any other criteria or modifications. All other details not specifically referred to should remain as tested or assessed.
- This report is issued on the basis of test data and information to hand at the time of issue. If contradictory evidence becomes available to Warringtonfire, the assessment will be unconditionally withdrawn, and the applicant will be notified in writing. Similarly, the assessment should be re-evaluated if the assessed construction is subsequently tested since actual test data is deemed to take precedence.
- This assessment has been carried out in accordance with Fire Test Study Group Resolution No. 82: 2001.
- Opinions and interpretation expressed herein are outside the scope of UKAS accreditation.
- This assessment report relates only to those aspects of design, materials and construction that influence the performance of the element(s) under fire resistance test conditions that are stipulated in the standard this assessment concludes to. It does not purport to be a complete specification ensuring fitness for purpose and long-term serviceability. It is the responsibility of the client to ensure that the element conforms to recognised good practice in all other respects and that, with the incorporation of the guidance given in this assessment, the element is suitable for its intended purpose.
- This report represents our opinion as to the performance likely to be demonstrated on a test in accordance with the standard to which this assessment concludes, on the basis of the test evidence referred to in this report. We express no opinion as to whether that evidence, and/or this report would be regarded by any Building Control authorities or any other third parties as sufficient for that or any other purpose.
- This report may only be reproduced in full. Extracts or abridgements of reports shall not be published without permission of Warringtonfire. All work and services carried out by Warringtonfire Testing and Certification Limited are subject to, and conducted in accordance with, the Standard Terms and Conditions of Warringtonfire Testing and Certification Limited, which are available at <https://www.element.com/terms/terms-and-conditions> or upon request.
- Previous versions of the report(s), if applicable, are withdrawn from the date of the up-issued assessment report with immediate effect. That means that they may no longer be relied upon in support of any products being placed on the market (or for the stated project/address where applicable) from the issue date stated on the front cover of this report. The withdrawal of an assessment report does not affect any reliance placed on the report up to the issue date stated on the front cover of this assessment; however, going forward, the up-issued report must be referenced in any literature or product specifications in place of the previous versions of the assessment.

16 Validity

- 1) This assessment report is not valid unless signed by all signatories identified within this Validity section of this report.
- 2) The assessment validity is as stated on the front cover of this report, after which time it is recommended to be submitted to Warringtonfire for re-appraisal.
- 3) This assessment report is not valid unless it incorporates the declaration given in Section 14 duly signed by the applicant.

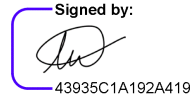
Position:	Assessor	Reviewer
Signature:	 <p>Signed by: E399772B03874B1...</p>	 <p>Signed by: 43935C1A192A419...</p>
Name:	E L Wilson*	N Whitelock*
Title:	Senior Product Assessor	Technical Manager, Doors & Smoke Leakage

* For and on behalf of Warringtonfire

Appendix A: Revisions

Rev.	WF Ref.	Date	Description
D		23.5.2000	5 year revalidation and update to include Halspan 60 steel/aluminium frame doorsets and all additional test evidence
E	Chilt/A01207	14.12.2001	5 year revalidation and update including additional test evidence
F	Chilt/A03031	18.6.2003	Incorporation of additional test data to justify the use of Sureguard edge protectors and sheet facing, increase the glazing options, allow the use of wireways and MDF frames and to appropriately amend the maximum leaf dimensions. Extra ironmongery items were also incorporated.
G	Chilt/ A05007	24.01.2005	Update to include new test data covering lippings, ironmongery, glazing, intumescent seals and framing.
H	Chilt/ A10028	19.07.2010	Update to include new test data covering hardware, glazing, intumescent seals and fire stopping details. The report has been technically reviewed and revalidated for a further 5 year period.
I	Chilt/ A10028	21.10.2010	Update to include grooves with hardwood inserts, reinstate security viewers, new sealing to structural opening section, recessed push/kick plates, 25mm thick Pyrobel glass added and larger doorset sizes assessed
J	Chilt/ A11177	5.10.2011	Update to include test evidence for Prima Plus design. Scope of application for Prima Plus design is contained in appendix G
K	Chilt/ A12065	9.05.2012	Update to include large leaf sizes based on test RF07128 and inclusion of Pilkington Pyroshield 2 scope
L	Chilt/ A12292	23.11.2012	Update to include Pyroguard FD60 glass based on test RF10080
M	WF387440	08.08.2017	Technical review and 5 year revalidation; update to Exova branding; inclusion of STS perimeter and glazing seal intumescents. Use of beech removed.
N	WF404746	12.09.2018	Amendment to correct Primary Data table and Data Sheet graph for Sealed Tight Solutions perimeter intumescents.
O	WF518301	22.06.2022	Revision of scope for overhead concealed closers. <u>Summary of change:</u>

			(1). Updated scope for Dorma IT96 concealed overhead closer. (2). Updated scope for Rutland IT11204 concealed overhead closer
P	WF530657	30/04/24	<p>Full revision and reappraisal of assessment scope in new report layout based on BSEN15725 and reformatting of report in the new Warringtonfire brand and layout. Review and revalidation for 5 years.</p> <p>Revised assessment to cover on timber based frames with Prima 60 (54mm core), as Part 1.</p> <p>The suite of FEA/F96103 field of applications for the Prima 60 product family is intended to comprise the following separate assessments:</p> <ul style="list-style-type: none"> • Part 2 – Prima 60 in Steel Frames • Part 3 – Prima 60 with bond up designs • Part 4 – Prima 60 with PVC products • Part 5 – Prima Plus 60
Q	WF544568	24/05/24	<p>Updates to the following elements:</p> <ul style="list-style-type: none"> • Inclusion of PVC/ ABS lippings over hardwood lippings for frames 3,4 & 5 • Amendment to maximum glass thickness permitted. • Update to chamfered bead options for glazing Systems 5 & 7 • Note added to section 10.2 (Drop Seals) • Typographical and drawing amendments • Cableway Method 2 Update to Configurations • Amendment to permitted viewer positioning. • Fire door identification plate positioning. • Update to Door Gap section 11.7
R	WF555367	20/10/2025	<p>Updates to sections 6.3 (Glazing System 7), 6.3.1.3 (in relation to cableway method 4), 10.4.5.1 (H100 handle considered) and 10.9.2.4 (glazing system amended to 5 with additional details) and typographical edits.</p>
S	WF556209	02/12/2025	<p>Update to section 10.4.5.1 (E100 Standard escutcheon Euro profile handle considered).</p>